

Qx IP | SDI

USER MANUAL

Software Release 4.1



About this Manual

Notice

The information in this document has been produced by PHABRIX Ltd with care and is believed to be accurate. PHABRIX Ltd does not assume responsibility for loss or damage resulting from errors, omissions or inaccuracies herein. This document is subject to change, and revisions may be made and issued to include such changes.

No part of this document may be reproduced, stored in a retrieval system, or transmitted in any form or by any means, electronic, mechanical, recorded or otherwise without the prior written consent of PHABRIX Ltd.

Copyright © PHABRIX Ltd. All rights reserved. Software products licensed are owned by PHABRIX Ltd and are protected by international treaty provisions and national copyright laws.

HDMI® is the registered trademark of HDMI Licensing and is used within the document for identification purposes only.

PHABRIX® Limited

Omega House
Enterprise Way,
Thatcham, Berkshire
RG19 4AE

phone: + 44 (0)1635 873030

email: support@phabrix.com

United Kingdom

www.phabrix.com

Revision

This manual is a revision controlled document. Any changes to any page content will be reflected in the overall revision status of the whole manual.

Release	Date	Software Version	Updates Include:
17a	November 2020	4.1	Addition of Dual PTP (2110) and Loudness Instruments. Support for DVI KVM Extenders.
16b	June 2020	3.4.1	Remote Qx software upgrade using SFTP. Enhancements to IP and NMOS Date and Input Name in Message Center of Picture and Picture - Copy Instrument.
16a	March 2020	3.4	Support for Networked Media Open Specification (NMOS) network protocols: AMWA IS-04 Discovery and Registration and AMWA IS-05 Device Connection Management.
15b	April 2020	3.3.1	Eye time cursors available with the SDI Stress Testing toolset. By installing this release, subsequent releases can be installed remotely using SFTP.
15a	March 2020	3.3	Support of closed caption standards CEA-608 and CEA-708 and OP47 (RDD-08); support of dual language closed caption review in dual picture window (picture and picture copy with second language overlay); safe area indicator; ATC timecode extract and on-screen display in picture window, and SCTE104 trigger indicators – detection and on-screen indication.
14a	12 December 2019	3.2	Enhanced IP ST 2110 Measurement capabilities (PHQXO-IP-MEAS) including: 2110-21 receive VRX, Cmax measure, advanced video timing, dual port interpacket timing windows, enhanced PTP (manual selection and crash lock mechanism), Link Layer Discovery Protocol (LLDP) support, Source Specific Multicast and PTP timing vs external reference.
13a	11 November 2019	3.1	Suite of new tools for 12G SDI Stress Analysis. Includes control of individual BNC outputs, USB file manager, automated Eye overshoot measurements, new Jitter waveform histogram, addition of new high-frequency pathological test signal (CLK).
12k	16 July 2019	3.0	Suite of new tools for SMPTE ST 2110/2022-7 IP analysis.
11e	10 June 2019	2.6	Advanced SDI Stress Toolset: Eye Amplitude Window, Shorth Mean analysis option; Adjustable Slew rate for generated signal. Support for Quad Link 1.5G Square Division video standards. S-Log3 version of ITU-R BT.2111-0 HDR Color Bars test pattern added. PRBS Analysis now supports SDI SFPs, and 'auto scan' mode for BNCs. Dolby E timing line number display in Audio Meters. Qx Restart GUI selection. SFP Configuration Database Reset.
10	7 Feb 2019	2.5	Generator Configuration (New UI with Video and Audio tabs), enhanced support for user test image files, 12G-SDI SFP Support for dual Rx, dual Tx and transceivers. Loop SDI In-to-Out (BNC). ANC Inspector, enhanced ANC Status, AES IO Config, Audio Channel Status, Generator Status (audio status added), OP47 Closed Captions display in Picture. Customizable positioning of Nits V Scale in Waveform.
9d	10 Sep 2018	2.4	Advanced SDI Stress Toolset: Advanced SDI Generation control & analysis, Jitter Insertion, PRBS Mode, Pathological Detect with GPI triggering. Sync Bit Removal, SDI output copy, Image parameter overrides moved to 'Analyzer - Video Standard', input cable length measurement, extended CRC Analysis features. New Rec. 2020 SDR video standards, new S-Log3 video standards, new ITU-R test patterns for HDR. Nits graticule for SDR (Gamma), HLG, PQ, SR-Live, S-Log3 added to Waveform, Rec.2020 targets in Vectorscope. User markers added to Vectorscope and Waveform; center on Vectorscope markers. Vectorscope Cb Cr markers displayed in Waveform.
8	4 May 2018	2.2	Screen capture, moving test patterns, layout Presets, VNC, SFTP, web browser. New HLG video standards, new Rec. 2020 support, PsF video standards. Audio monitoring on SDI Instrument Output. Diffuse White Marker in Waveform for HDR standards. Extended REST API support for 2022-6 IP instrument suite.
7	21 Dec 2017	2.0.1	32-channel Audio Generation. Extended REST API support for audio generation, and CRC error reporting. Cursors linking Picture, Dataview, and Waveform. Qx factory default setting.
6a	6 Nov 2017	2.0	New 2022-6 IP instrument suite. Support for 1.5 & 3G standards over IP. Support for IP Transmit reference locking. IP Decapsulated SDI timing against reference with Input Measurement Offset. SDI/IP mode firmware switching. CIE Chart pan and zoom.
5	7 Sep 2017	1.0.3	Driver Calibration description
4	21 Aug 2017	1.0.3	HDR Heat-map, CIE 1931 x y Chart, HDR/WCG additions for Waveform and Vectorscope, and new PQ video standards. REST API for remote control and automation. CRC Analysis frame change detection added.
3	20 Jun 2017	1.0.2	Reference locking support with Output offset adjustment. Input timing against reference with Input Measurement Offset.

Release	Date	Software Version	Updates Include:
2	21 Mar 2017	1.0.1.227	Addition of Waveform, Vectorscope, HDMI audio and new video standards.
1	23 Jan 2017	1.0.0.196	First release of manual

General Safety Information

General Safety

Avoiding Personal Injury



This instrument is designed for use by qualified personnel only.

No user serviceable parts are provided. Units should be returned to your local PHABRIX agent for servicing.

The Operator should NOT remove the case from the unit.

Do not spill any liquid onto the unit or its power adaptor.

Power Supply

Make sure that the unit is connected to the correct power supply voltage. A power supply adaptor is supplied with the unit which may be connected to any AC power supply between 100 and 240 VAC at 50-60 Hz. Only the supplied power adaptor should be used with the unit. Do not use a damaged AC cable with the unit as it may cause a shock or fire hazard. Replacement AC cables are available from your local PHABRIX agent.

Installation Environment

Operating Temperature



The unit should only be operated between 0 and 40°Celsius non-condensing. If the temperature is changed rapidly from a cold environment to a hot environment, moisture can be created internally which can cause malfunction or damage the unit. Allow the unit to sit for 30 minutes without power applied to reduce any possibility of condensation. If the internal component temperature rises above 85°Celsius the unit will turn OFF automatically.

Input/Output Terminals

Do not connect the input or output BNC connectors to external power as this can damage the internal circuitry and cause the unit to work incorrectly.

The BNC connectors fitted on this unit are 75 ohm type which are not compatible with 50 ohm plugs.



The use of 50 ohm plugs will permanently damage the connectors on the unit. The use of 50 ohm plugs is considered to be misuse of the equipment and will therefore invalidate the unit's warranty.

When Not In Use

Disconnect the unit from the power supply and AC power source when not in use.

Maintenance

Wipe the case gently with a soft cloth, lightly dampened with a neutral cleaning agent.



Remove the power supply from the unit and turn OFF before cleaning. Do not allow any water or other liquid to enter the unit while cleaning.

RoHS 2 Compliance

PHABRIX products are designed and manufactured using only RoHS compliant components and materials. Therefore based on information provided by our suppliers, PHABRIX certifies that ALL products that it manufactures are “RoHS-5” compliant and that they do not exceed the designated levels of lead, cadmium, mercury, hexavalent chromium, polybrominated biphenyl (PBB) and polybrominated diphenyl ether flame retardants (PBDE) legislated under the provisions of the “European Parliament and Council Directive” on the “Restriction of the Use of Certain Hazardous Substances in Electrical and Electronic Equipment (2011/65/EC)” and associated regulations collectively known as the “RoHS Regulations”.

Disposal of Equipment



This product is subject to the European WEEE (Waste Electrical and Electronic Equipment) directive and should be disposed of according to the regulations of each country.

Table of Contents

About this Manual	III
Notice	III
Revision	IV
General Safety Information	VI
General Safety	VI
Avoiding Personal Injury	VI
Power Supply	VI
Installation Environment	VI
Operating Temperature	VI
Input/Output Terminals	VI
When Not In Use	VI
Maintenance	VI
RoHS 2 Compliance	VII
Disposal of Equipment	VII
1	1-1
Getting Started	1-1
Getting Started Quick Reference	1-2
What's in the Box?	1-2
Mounting the Unit	1-2
Desktop Mounting	1-2
Rack Mounting	1-2
Overview of the Qx Rear Panel Connectors	1-4
Connecting Essential Cables to the Unit	1-5
Powering-up the Qx	1-7
SDI and IP Connections	1-8
Connecting for an SDI Installation Using BNC Connectors	1-8
Connecting for an SDI or IP Installation Using SFP Modules	1-8
Powering-down the Unit	1-10
2	2-1
Working with the User Interface	2-1
Overview of the Product Structure	2-2
Introduction	2-2
Toolsets and Instruments	2-2
Standard Toolsets	2-3
Standard Toolset	2-3
SDI and Reference Toolset	2-3
Advanced Qx Toolsets	2-4
Audio and Video Generation Toolset	2-4
12G-SDI Physical Layer Analysis Toolset	2-4
SDI Stress Testing Toolset	2-4
IP Toolsets	2-5
Standard IP Monitoring Toolset for ST 2110 and ST 2022-6	2-5
IP Network Traffic Measurement Toolset for ST 2110 and ST 2022-6	2-5
IP ST 2022-6 Packet Interval Profile Generator Toolset	2-5
Media-related Toolsets	2-6
Advanced High Dynamic Range (HDR) Visualization and Analysis Toolset	2-6
Data View Analyzer with ANC Inspector Toolset	2-6

Accessing the Qx Instruments	2-7
Overview of the Qx Main Screen	2-7
Using the Instrument Launch Menu	2-8
Using the Instrument Bar	2-9
Using the Instrument Bar Options Menu	2-10
Controlling the Audio Monitoring Source	2-11
System Time and Date Display	2-12
Using System State Presets and the Preset Bar	2-12
Overview of the Instrument Windows	2-14
Changing the Border Color of Instrument Windows	2-14
Working with the Qx Instruments	2-15
Selecting Submenu Options and Entering Values	2-15
Resizing an Instrument Window	2-16
Using the Instrument Scroll Bars and Scroll Control Menu	2-17
Taking Screenshots	2-17
Working with Instrument Tabs	2-17
Instrument Icon Quick Reference	2-19
3	3-1
Configuring and Checking the Unit	3-1
Qx Network and Automation	3-2
Overview	3-2
Using VNC to Connect Remotely to the Unit	3-2
Instrument Menu Options	3-3
Setting the Time, Date and NTP Server	3-5
Setting-up the Display	3-6
Modifying the Display Options	3-6
Checking the Unit	3-8
Overview	3-8
Checking the System Health Status	3-8
Checking the Unit Licenses	3-9
Restarting the Unit	3-10
Reverting to Factory Default Settings	3-10
Switching Between Boot Modes	3-11
Resetting the SFP Configuration Database	3-13
Upgrading the Unit	3-15
Upgrading the System Software and Firmware	3-15
Remote Upgrade Using SFTP	3-16
Upgrading the Software Options	3-16
Managing Files with the USB File Manager	3-19
Overview	3-19
Opening the USB File Manager	3-19
Copying Files from the Unit to USB	3-20
Uploading Files from USB to the Unit	3-21
Deleting Files from the Unit	3-21
Event Logging on the Unit	3-22
Overview	3-22
SDI Modes	3-22
IP Modes	3-22
Remote Connection to the Unit	3-23

Overview	3-23
Available Functionality	3-23
Using Virtual Network Computing (VNC)	3-24
Using Secure FTP (SFTP)	3-24
Connecting to the Unit Using SFTP	3-24
Using a Web Browser	3-24
Connecting to the Unit Using a Web Browser	3-25
4	4-1
SDI System Setup and Configuration	4-1
SDI Connections to the Unit	4-2
Overview	4-2
SDI Input and Output Schematic	4-3
SDI Input / Output Configurations (SDI Modes)	4-4
SDI Inputs Using BNC Connectors	4-5
SDI Outputs Using BNC Connectors	4-5
Overview of SDI SFP Connections	4-7
SDI Inputs Using SFP Connectors	4-8
SDI Outputs Using SFP Connectors	4-8
System IO for SDI Modes	4-9
Overview	4-9
System IO for SDI Modes	4-9
Instrument Menu Options	4-9
AES IO Config (SDI Mode)	4-12
Overview	4-12
Instrument Menu Options	4-13
Video Timing & System Reference (SDI Modes)	4-14
Overview	4-14
Video Timing in SDI Mode	4-14
SDI A vs System Reference	4-14
SDI Co-Timing	4-14
Instrument Menu Options	4-15
SFP (A, B) - Info (SDI Modes)	4-16
Overview	4-16
Instrument Menu Options	4-16
5	5-1
IP System Setup and Configuration	5-1
IP Connectors and Modules	5-2
Overview	5-2
IP Input and Output Schematic (ST 2022-6)	5-3
IP Input and Output Schematic (ST 2110)	5-4
IP Interfaces to the Unit	5-5
Overview	5-5
ST 2110 Input Optical SFP Interfaces (Analyzer - IP 2110 Mode)	5-5
ST 2022-6 Input Optical SFP Connection (Analyzer - IP 2022-6 Mode)	5-6
ST 2022-6 Output Optical SFP Connection (Generator - IP 2022-6 Mode)	5-6
System IO for IP Modes	5-7
Overview	5-7
System IO for IP Modes	5-7
SFP IP Network	5-8

Overview	5-8
Instrument Menu Options	5-8
LLDP Information	5-11
Overview	5-11
Instrument Menu Options	5-12
SFP (A, B) - Info (IP Modes)	5-13
Overview	5-13
Instrument Menu Options	5-13
IP Receive - NMOS (IP 2110 Mode)	5-14
Overview	5-14
Instrument Menu Options	5-15
SFP A/B - PTP Info (IP 2110 Mode)	5-17
Overview	5-17
GM Info Tab	5-18
Qx Status Tab	5-19
PTP Messaging Tab	5-19
Instrument Menu Options	5-20
Video Timing & System Reference (IP Modes)	5-23
Overview	5-23
Timing in IP 2022-6 Mode: Decapsulated vs System Reference	5-23
Instrument Menu Options	5-24
Video Timing & Setting External Reference in IP 2110 Mode	5-26
Overview	5-26
External Reference vs PTP Tab	5-26
Instrument Menu Options	5-26
IP Receive - Flow Select	5-28
Overview	5-28
Instrument Menu Options	5-29
Multicast Setup (Multicast Requests)	5-31
Using the Instrument Controls	5-31
Flow Protocol Configuration (Flow Config)	5-33
Using the Flow Config Controls	5-33
Analyzer - 2110 Format Setup (IP ST 2110 Mode)	5-35
Overview	5-35
Instrument Menu Options	5-36
Video Timing & System Reference (IP 2110 Mode)	5-38
Overview	5-38
Video Timing in IP 2110 Mode	5-39
Overview	5-39
Media Latency Tab	5-39
Instrument Menu Options	5-40
AES IO Config (IP Modes)	5-42
Overview	5-42
Instrument Menu Options	5-43
6	6-1
Signal Generation Instruments	6-1
Generate - Video	6-2
Overview	6-2
Test Patterns	6-3

User Test Patterns and Images	6-4
Generator Copy and SDI Out Configuration	6-4
Insertion of SMPTE ST352 Payload IDs	6-6
Pathological Signal Insertion	6-7
Output Offset Adjustment (SDI Modes)	6-7
Generate - Audio	6-9
Generator - Status	6-11
Overview	6-11
IP Transmit (SFP B) (ST 2022-6 Mode)	6-12
Overview	6-12
Network Settings	6-13
7	7-1
Standard Analysis Instruments	7-1
Analyzer - Video Standard (SDI and ST 2022-6 Modes)	7-2
Overview	7-2
Instrument Menu Options	7-2
Ignore Payload Identifier Packets (ST 352)	7-2
Sub Image Pixel Mapping Format Override	7-2
Stats - SDI In A, B, C, D (SDI Modes)	7-3
Overview	7-3
Stats - IP Receive (SFP A) (ST 2022-6 Mode)	7-4
Overview	7-4
8	8-1
Network Analysis Instruments	8-1
Analyzer - 2022-7 Status (IP ST 2110 Mode)	8-2
Overview	8-2
Instrument Menu Options	8-3
SFP (A, B) - Network Stats	8-4
Overview	8-4
9	9-1
Content Analysis Instruments	9-1
Analyzer - Picture	9-2
Overview	9-2
Instrument Menu Options	9-3
Using Closed Captions	9-6
Using Dual Picture Instruments	9-7
Monitoring Closed Captions in Dual Picture Instrument Windows	9-8
Picture Cursor	9-9
Using the Picture Safe Areas	9-9
Displaying the Picture Safe Areas	9-10
Using the Message Center	9-11
SCTE 104 Packet Detection	9-12
Defining Source Input Names	9-12
Displaying the Ancillary Time Code (ATC)	9-13
On Video Loss (IP ST 2110 Mode)	9-14
Analyzer - Waveform	9-15
Overview	9-15
Instrument Menu Options	9-15
Analyzer - Vectorscope	9-17

Overview	9-17
Instrument Menu Options	9-17
Analyzer - CRC Analysis	9-18
Overview	9-18
Instrument Menu Options	9-19
10	10-1
Audio Signal Analysis Instruments	10-1
Analyzer - Audio Channel Status	10-2
Overview	10-2
Raw Data Display	10-3
Instrument Menu Options	10-3
Analyzer - Audio Meters	10-4
Overview	10-4
Instrument Menu Options	10-6
Analyzer - Loudness Monitor	10-7
Overview	10-7
Summary Loudness Monitoring Process	10-8
Audio Assignment for Loudness Monitoring	10-9
Audio Meters for Loudness Inputs	10-10
Understanding the Loudness Meters and Values	10-10
True Peak Value	10-12
Momentary Loudness Value and Error Count	10-13
Short-term Loudness Value and Error Count	10-13
Integrated Loudness Value and Error Count	10-13
Loudness Range Value	10-13
Using the Loudness Controls	10-14
Using the Loudness History Graph	10-14
Resetting Loudness Values and Errors	10-15
Managing the Loudness Log Files	10-15
Retrieving the Loudness Log Files	10-16
Renaming the Loudness Logfile Base Name	10-17
Instrument Menu Options	10-18
11	11-1
Data Analysis Instruments	11-1
Analyzer - Dataview	11-2
Overview	11-2
Instrument Menu Options	11-3
Analyzer - Ancillary Status	11-4
Overview	11-4
Instrument Menu Options	11-5
Analyzer - Ancillary Inspector	11-8
Overview	11-8
Instrument Menu Options	11-8
12	12-1
IP Network Traffic Measurement	12-1
IP Receive - Interpacket Timing	12-2
Overview	12-2
Interpacket Timing in IP 2022-6 Mode	12-3
IP 2022-6 Instrument Menu Options	12-3

Interpacket Timing in IP 2110 Mode	12-4
IP 2110 Instrument Menu Options	12-5
Analyzer - 2110-21 Status (IP ST 2110 Mode)	12-7
Overview	12-7
Measurements and Instrument Menu Options	12-8
Measurement Prechecks	12-8
Network Compatibility Model Measurement (CINST)	12-8
Virtual Receiver Buffer Measurement (VRX)	12-10
Advanced Media Timing Measurement (IP 2110 Mode)	12-13
Overview	12-13
Using the Advanced Video Timing Tab	12-14
Using the Advanced Media Latency Tab	12-14
Instrument Menu Options	12-15
13	13-1
12G Physical Layer Analysis	13-1
Eye - SDI In A (Physical Layer Analysis Mode)	13-2
Overview	13-2
Instrument Menu Options	13-3
Jitter - SDI In A (Physical Layer Analysis Mode)	13-5
Overview	13-5
Instrument Menu Options	13-5
14	14-1
Stress-testing Analysis Instruments	14-1
Advanced Generation Tools (SDI Stress Mode)	14-2
Overview	14-2
SDI Scrambler	14-2
Sync Bit Insertion (6G / 12G)	14-2
PRBS Mode	14-3
Jitter Insertion	14-3
Slew Rate	14-4
Driver and Output Control	14-4
Cable Compensation	14-4
Eye - SDI In A (SDI Stress Mode)	14-6
Overview	14-6
Using the Eye Time Cursors	14-7
Instrument Menu Options	14-8
PRBS Analysis (SDI Stress Mode)	14-11
Overview	14-11
Instrument Menu Options	14-11
15	15-1
HDR Analysis Instruments	15-1
Advanced HDR Toolset	15-2
Overview	15-2
HDR Test Patterns	15-2
Transfer Curve and Colorimetry Overrides	15-3
Analyzer - CIE Chart	15-4
Overview	15-4
Instrument Menu Options	15-4
HDR Heat-map (False Color Overlay)	15-6

Instrument Options (HDR)	15-7
16	16-1
Additional System Information	16-1
Using the REST API for Remote Access	16-2
Activating the REST API	16-2
Connecting Using the REST API	16-2
Using REST API Requests	16-3
Using REST API Requests in SDI Mode	16-3
Using REST API Requests in IP Mode	16-4
Driver Calibration	16-5
Overview	16-5
SDI Output Calibration Steps	16-5
A	A-1
Technical Specifications	A-1
Power	A-2
External Locking Reference	A-2
SDI Instrument Output	A-2
HDMI Instrument Output	A-2
USB	A-2
Networking	A-3
Rear panel D26	A-3
GPIO	A-4
AES I/O	A-4
Longitudinal Timecode (LTC)	A-5
Analog Audio Output	A-5
B	B-1
Advanced Media Timing Information	B-1
Overview	B-2
Advanced Media Timing Definitions	B-2
Video IP Packet Timing Schematics	B-2
Measurements in the Video Timing Tab	B-5
Video Timing (First Packet Time) Measurement	B-5
Margin Measurement	B-7
RTP Offset Measurement	B-7
Measurements in the Media Latency Tab	B-8
Media Latency Measurement	B-8
RTP Clock and Timestamps	B-9
RTP Clocks per Timestamp Quotient (RTP / TS)	B-10
Working with Non-integer Frame Rates	B-11
Un-locked Media Sources	B-12
Sources Not Locked to PTP	B-12
C	C-1
On-going Development	C-1
SMPTE UHDTV: SDI Physical Layer Tolerances	C-1
D	D-1
Supported SFPs	D-1
E	E-1
Supported Video Standards	E-1
2K/HD Supported Formats	E-1

Getting Started

This chapter describes how to connect your unit to get it up and running and includes the following sections:

- [Getting Started Quick Reference](#)
 - [What's in the Box](#)
 - [Mounting the Unit](#)
- [Overview of the Rear Panel Connectors](#)
- [Connecting Essential Cables to the Unit](#)
- [Powering-up the Unit](#)
- [SDI and IP Connections](#)
- [Powering-down the Unit](#)

Getting Started Quick Reference

What's in the Box?

On receipt of your shipment, proceed as follows:

1. Check the external packaging for any visible signs of damage.
Should you find any damage, contact the courier immediately.
2. Carefully open the packaging and check that it contains the following standard items:
 - One Qx unit; either:
 - PHABRIX Qx chassis: PHQX01-3G or
 - PHABRIX Qx chassis: PHQX01E-3G (with Eye and Jitter Physical Layer Analysis)
 - One XLR power cord.
 - One AC power adapter (90 - 264 VAC, 120 W)
 - PHABRIX USB stick containing standard software with any ordered software options and User Manual in PDF format.
3. Check all optional items against your order form or invoice.
4. If you suspect optional items are missing, contact your Distributor or PHABRIX support at: <https://phabrix.com/support/>
5. Complete the Product Registration form available at: <https://phabrix.com/support/product-registration>

Mounting the Unit

You can install the Qx as a standalone unit on a desktop or rack-mount the unit or units using one of the following optional rack-mounting kits:

- For a single unit, use both options:
 - 19 inch rack mount kit (PHQXK1)
 - Mounting kit - 9.5 inch rack (PHQXK3)
- For two units:
 - 19 inch rack mount kit (PHQXK2)

Desktop Mounting

To desk mount a standalone unit, place it on a clean, level dust-free surface and connect the cables as described in the section ["Connecting Essential Cables to the Unit" on page 1-5](#). Ensure that the unit is positioned to allow sufficient airflow for cooling purposes.

Rack Mounting

To rack-mount one or more units in a 19 inch rack, follow the procedure in the instruction guide included with the mounting hardware. Ensure that the unit(s) have an unrestricted airflow and access to the power connectors in the rack.

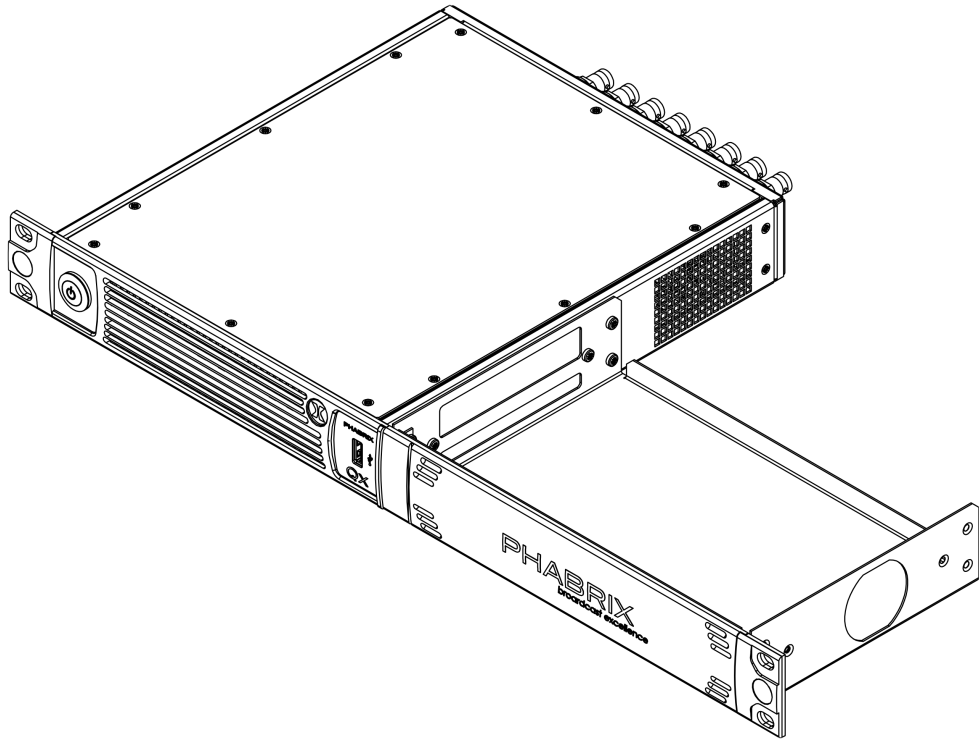

Figure 1-1: Single Rack Mount Tray with Cover (Option PHQXK1)

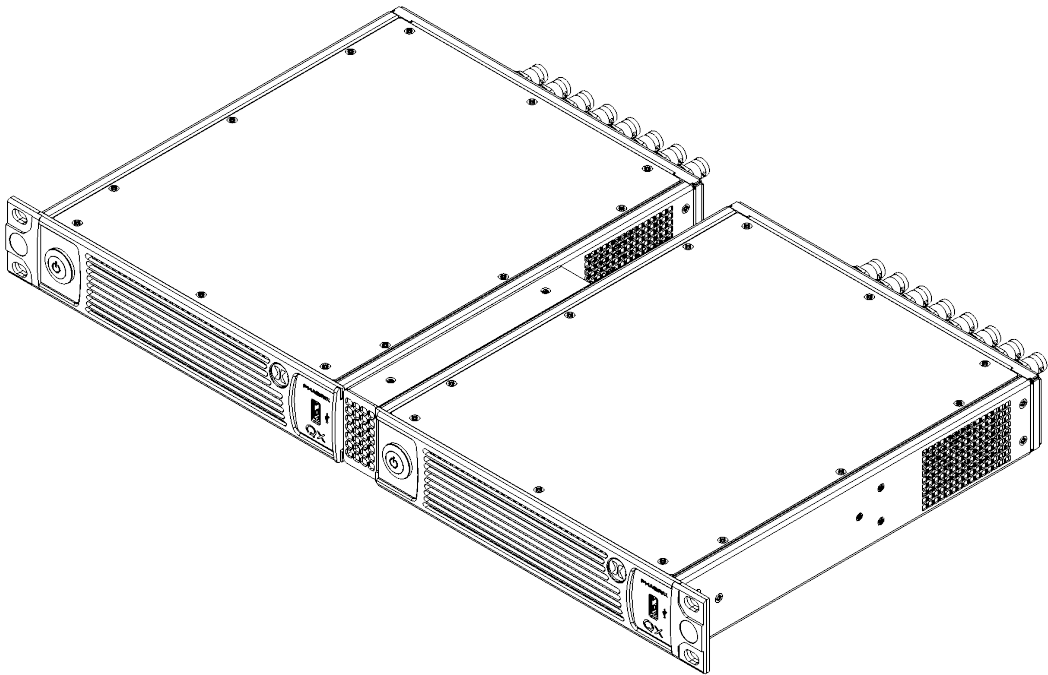

Figure 1-2: Dual Rack Mount (Option PHQXK2)

Overview of the Qx Rear Panel Connectors

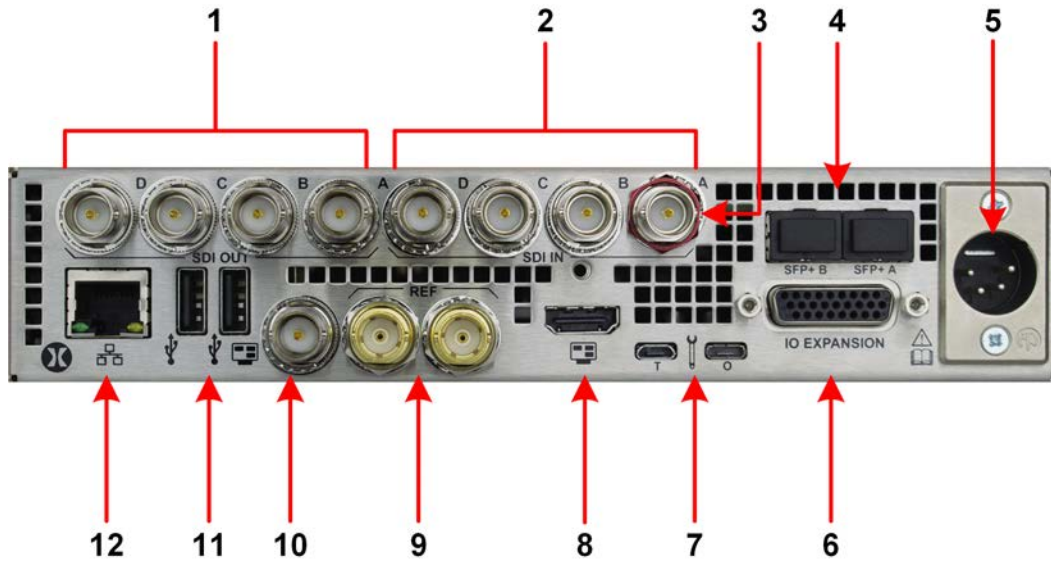

Figure 1-3: Qx Rear Panel Connectors

The Qx rear panel connectors are described in the following table:

Table 1-1: Key to Qx Rear Panel Connectors

No.	Connector	No.	Connector
1	Generator/Duplicate SDI or Input SDI Loop Outputs Supported formats: HD, 3G, 6G, 12G. SDI 75 R BNC Connectors x 4	7	Micro USB (Factory Service)
2	Analyzer SDI Inputs Supported formats: HD, 3G, 6G, 12G SDI 75 R BNC Connectors x 4	8	HDMI Instrument Output (To 1080p60) Also supports auto DVI mode over HDMI to connect DVI KVM Extenders for remote installations.
3	SDI In A Eye Signal Supported formats: HD, 3G, 6G, 12G	9	Reference Loop 75R BNC x 2
4	Analyzer IP or SDI Inputs and/or Generator IP or SDI outputs (SFP+ SDI up to 12G, 12 Gbps copper, fiber, or 10G Ethernet).	10	SDI Copy Instrument Output 75R BNC Formats: 1080p 50, 59.94, 60 3G-SDI
5	AC Power Socket (10 - 18 V)	11	USB 2.0 Ports x2
6	Stereo Audio Out LTC In, 8x GPI I/O, 4x AES I/O For details of the connector pinouts, see Appendix A.	12	Control Network / Management Port 10 / 100 / 1000 Base T

Note:

The following interfaces are unavailable in this software release:

- LTC In
- SDI instrument output (unavailable in IP 2110 boot-up mode only.)

Connecting Essential Cables to the Unit

After unpacking your Qx unit, you can get it up and running either as a standalone instrument on a desktop, or mounted in a rack, using the appropriate mounting kit, if ordered.

Proceed as follows to obtain an output to a video display using the connectors shown in [Figure 1-4](#) below:

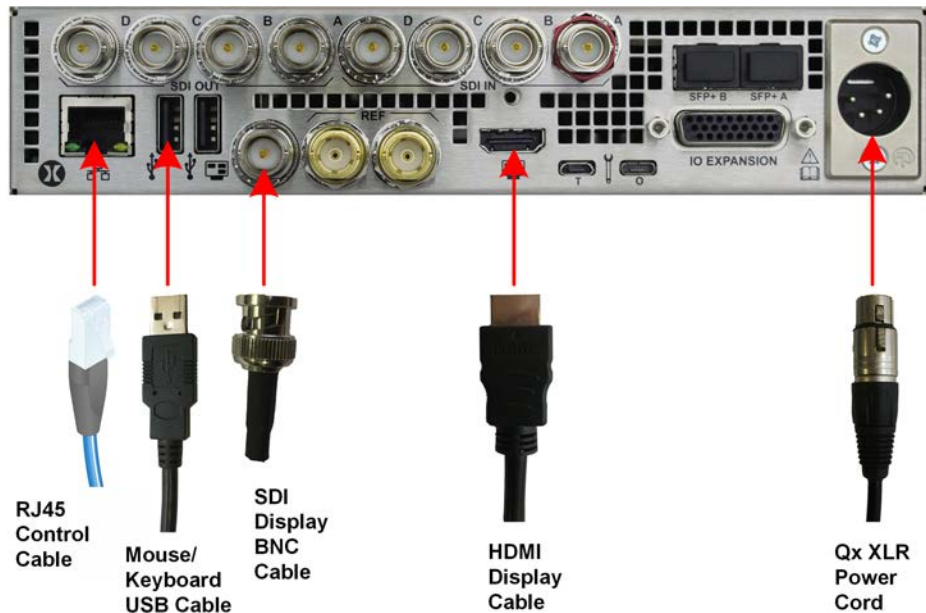

Figure 1-4: Qx Minimum Rear Panel Connectors

Connect the cables to the rear panel as follows:

1. Connect a suitable 1920 x 1080 capable monitor to either the HDMI instrument output or the SDI instrument output. Both display outputs carry the selected audio monitoring channel/pair. The monitor output can be configured for 1080p60, 1080p59.94 or 1080p50 frame rates using the Display Options submenu available from the **Instrument Launch Menu**. Either:
 - Connect an HDMI type A cable to the female HDMI connector on the rear of the Qx and the other end to your video monitor to obtain the instrument display, or
 - Connect an SDI BNC cable to the SDI Instrument output connector on the rear of the Qx and the other end to your video monitor to obtain the instrument display.

Note: The HDMI output supports auto DVI mode over HDMI to connect DVI KVM Extenders for remote installations.

2. Connect USB mouse/keyboard cables to the USB connectors on the rear of the Qx for mouse and keyboard control.
3. Connect an RJ45 cable to the management port. This enables you to access and control the unit remotely and to set the unit time using NTP.
4. Connect the four-pin, XLR power connector, on the power cord supplied with the unit, to the power socket on the unit.
5. Connect the plug on the other end of the power cord to a mains AC power outlet.
6. Switch on the power.
The unit will automatically start to power-up.

These are the minimum connections you need to power-up the Qx, obtain an output to the connected video display and control the Qx user interface.

Powering-up the Qx

Once connected to a power source, press the Power button on the front panel of the unit. You should see the status LED, behind the power button, light in the following sequence:

- **Blue:** Initial Start-up
- **Yellow (Blinking):** Configuring
- **White:** Running

When the you first press the Power Button on the front panel, the unit's fans will cycle for 20 to 30 seconds at high speed as the system boots, then settle to their normal operating speed.



Figure 1-5: Qx Front Panel

During standard operation, the Power button LED provides an indication of the current status of the unit. The following table lists some of the LED colors you may see and provides a description of the unit's status at that point.

Table 1-2 : Qx Power LED Status Indicators

LED Color	Description
White	Qx running well.
Magenta	Qx upgrading software / firmware.
Cyan	Qx busy.
Blue	Qx busy, for example, during Initial start-up sequence.
Yellow	Qx busy, for example, configuring modules and checking licenses. Do not switch off.
Red	Fault. Contact PHABRIX Support if red LED stays lit or continuously flashes red.

SDI and IP Connections

A key advantage of the Qx is that it includes both Generator and Analyzer, so this guide to the product considers both toolsets simultaneously.

Connecting for an SDI Installation Using BNC Connectors

For this guide we will assume that you have connected the unit to itself as shown in the following diagrams for SDI (BNC or SFP) or IP 2022-6 optical SFP use. For dual link SDI standards also connect SDI Out B to SDI In B, and for quad link SDI standards, connect all four outputs SDI Out A, B, C, D to SDI In A, B, C, D respectively.

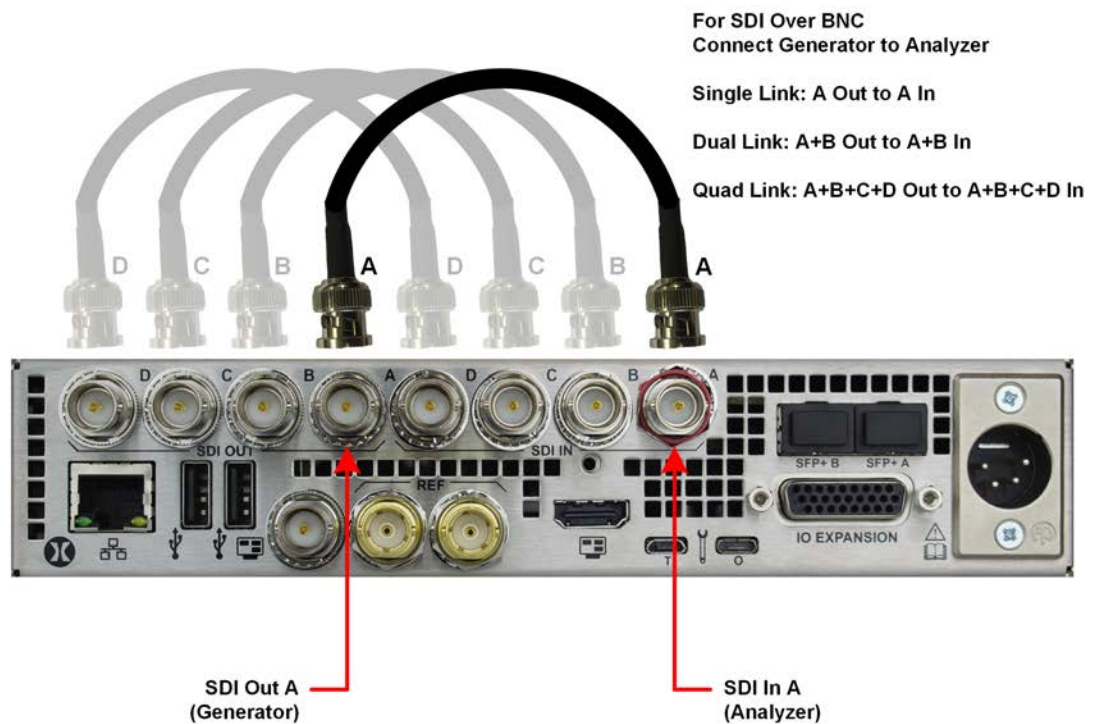

Figure 1-6: Connecting the Internal Qx Generator to the Analyzer Using BNC Connectors

Connecting for an SDI or IP Installation Using SFP Modules

In IP 2110 mode, both SFP+A and SFP+B are available for decapsulation (reception) and a stable source of ST 2059 precision time protocol (PTP) must be available on the network to which SFP+A is connected.

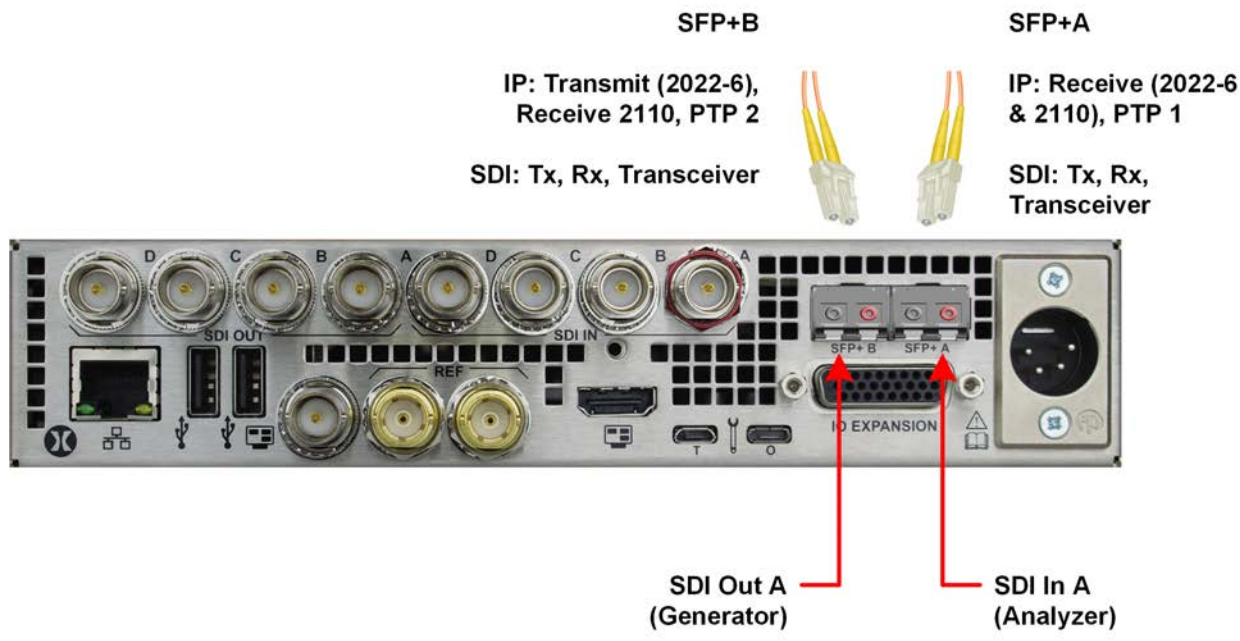

Figure 1-7: Connecting the Qx Using SFP Modules

Powering-down the Unit

To power-down the unit, press the Power Button on the front panel and the unit will shutdown after 10 seconds. To shutdown immediately, press the power button twice or click the **SHUT DOWN NOW** button displayed in the Shutdown window. To stop a shutdown, click **Cancel**.



Figure 1-8: Unit Shut-down Dialog

Working with the User Interface

This chapter describes how to use the key features of the user interface and includes the following sections:

- [Overview of the Product Structure](#)
- [Overview of the Main Screen](#)
- [Using the Instrument Launch Menu](#)
- [Using the Instrument Bar](#)
- [Overview of the Instrument Windows](#)
- [Working with the Instruments](#)
 - [Working with Instrument Tabs](#)
- [Icon Quick Reference](#)

Overview of the Product Structure

Introduction

The Qx is a highly-flexible, modular device, which you can custom-build from a diverse palette of both standard and optional components.

This chapter provides an introduction to these components - the Toolsets, Instruments and Options available with the Qx - which you can combine to create a solution that meets the specific demands of your media test and measurement environment.

Toolsets and Instruments

In essence, each Qx **Instrument** is a standalone utility or application designed to provide a specific solution to a test and measurement task. For example, the Qx provides Instruments to analyze the picture display or waveform; generate video or audio test signals; decode auxiliary data; provide status information and so on. You can adapt or modify the functioning of all Instruments using the configuration options available in the Instrument right-click submenus.

The Qx **Toolsets** group together Instruments at a higher functional level to assist with defining your ideal configuration.

It is important to note that Toolsets outside the standard Toolset(s) require additional **Options** (hardware or software) to enable you to install the license for that Toolset. In addition, you may need to restart the unit in a different **Boot Mode** to activate some of the Toolsets described in the following sections.

As standard, the Qx offers a flexible, user-defined, Instrument layout displaying up to 16 Instrument windows simultaneously. Furthermore, by saving different operational layouts for specific tasks as **Presets**, you can switch easily between bespoke layouts for rapid fault diagnosis, compliance monitoring and product development.

Standard Toolsets

Standard Toolset

The standard or core Toolset provides the following Instruments and associated utilities:

- Analyzer - Ancillary Status Instrument
- Analyzer - Audio Channel Status Instrument
- Analyzer - Audio Meters Instrument
- Analyzer - Loudness Monitor
- Analyzer - Picture and Analyzer - Picture Copy Instruments
- Analyzer - Vectorscope Instrument
- Analyzer - Waveform Instrument
- Event Logging Instrument
- Network and Automation Instrument
- Supporting standard utilities:
 - USB File Manager
 - VNC Remote Connection
 - REST API.

SDI and Reference Toolset

The SDI and Reference Toolset provides the following Qx Instruments:

- AES IO Configuration Instrument
- Analyzer - CRC Analysis Instrument
- Analyzer - Video Standard (SDI) Instrument
- Stats - SDI In A Instrument
- Stats - SDI In B Instrument
- Stats - SDI In C Instrument
- Stats - SDI In D Instrument
- System IO Instrument
- Video Timing & System Reference (SDI) Instrument.

Advanced Qx Toolsets

Audio and Video Generation Toolset

The Audio and Video Generation Toolset provides the following Instruments:

Note: This Toolset requires the software option: **PHQXO-GEN**.

- Generator - Configuration Instrument (Includes separate tabs for Video and Audio signal generation)
- Generator - Status Instrument.

12G-SDI Physical Layer Analysis Toolset

The 12G-SDI Physical Layer Analysis Toolset provides the following Instruments:

Note: This Toolset requires the additional hardware option for Eye and Jitter analysis **PHQXM-01E Mezzanine**.

- Eye - SDI In A Instrument
- Jitter SDI In A Instrument.

SDI Stress Testing Toolset

The SDI Stress Testing Toolset provides the following Instruments and tools:

Note: This Toolset requires the software option: **PHQXO-SDI-STRESS** and must be run in boot mode: **SDI Stress Toolset**.

- Advanced Generator Tools (Additional submenu item in Generator - Configuration Instrument)
- Advanced Eye Analysis (Additional submenu item in Eye - SDI In A Instrument)
- PRBS Analysis Instrument
- Pathological Detection Tools (Additional submenu item in Generator - Configuration Instrument).

IP Toolsets

Standard IP Monitoring Toolset for ST 2110 and ST 2022-6

The Standard IP Monitoring Toolset for ST 2110 and ST 2022-6 provides the following Instruments and tools:

Note: This Toolset requires the software option: **PHQXO-IP-STND** and must be run in boot mode: **IP 2110** for ST 2110 or **IP 2022-6** for ST 2022-6.

- Analyzer - 2022-7 Status Instrument (ST 2110 Only)
- Analyzer - 2110 Format Setup Instrument (ST 2110 Only)
- Analyzer - LLDP Data Instrument (ST 2022-6 and ST 2110)
- IP Media Latency tool (Tab in Video Timing & System Reference Instrument) (ST 2110 Only)
- IP Receive - Flow Select Instrument (ST 2022-6 and ST 2110)
- IP Receive - NMOS (ST 2110 Only)
- SFP A / B - PTP Information Instrument (ST 2110 Only)
- SFP A - Information Instrument (ST 2022-6 and ST 2110)
- SFP B - Information Instrument (ST 2022-6 and ST 2110)
- SFP A - Network Stats Instrument (ST 2022-6 and ST 2110)
- SFP B - Network Stats Instrument (ST 2022-6 and ST 2110)
- SFP IP Network Instrument (ST 2022-6 and ST 2110)
- Statistics - IP Receive (SFP A) Instrument (ST 2022-6 Only).

IP Network Traffic Measurement Toolset for ST 2110 and ST 2022-6

The IP Network Traffic Measurement Toolset for ST 2110 and ST 2022-6 provides the following Instruments and tools:

Note: This Toolset requires the software option: **PHQXO-IP-MEAS** and must be run in boot mode: **IP 2110** for ST 2110 or **IP 2022-6** for ST 2022-6.

- IP Receive - Interpacket Timing Instrument (ST 2022-6 and ST 2110)
- Analyzer - 2110-21 Status Instrument (IP ST 2110 Only)
- Advanced PTP Media Timing tool (Tab in Video Timing & System Reference Instrument) (ST 2110 Only).

IP ST 2022-6 Packet Interval Profile Generator Toolset

The IP ST 2022-6 Packet Interval Profile Generator Instrument Toolset provides the following Instrument:

Note: This Toolset requires the software options: **PHQXO-GEN** and **PHQXO-IP-NGT** and must be run in boot mode: **IP 2022-6**.

- IP Transmit (SFP B) Instrument (ST 2022-6 Only).

Media-related Toolsets

Advanced High Dynamic Range (HDR) Visualization and Analysis Toolset

The Advanced High Dynamic Range (HDR) Toolset provides the following Instruments and tools:

Note: This Toolset requires the software option: **PHQXO-HDR**.

- False Color Highlighting (Additional submenu item in Analyzer - Picture and Analyzer - Picture Copy Instruments)
- Analyzer CIE Chart Instrument.
- HDR Waveform and Gen (Additional submenu items in Generator - Configuration (Video) and Analyzer - Waveform Instruments).

Data View Analyzer with ANC Inspector Toolset

The Data View Analyzer with ANC Inspector Toolset provides the following Instruments:

Note: This Toolset requires the software option: **PHQXO-DATA**.

- Analyzer - Data View Instrument
- Analyzer - ANC Inspector Instrument.

Accessing the Qx Instruments

Overview of the Qx Main Screen

On first powering-up the unit, you will see the following screen displayed:

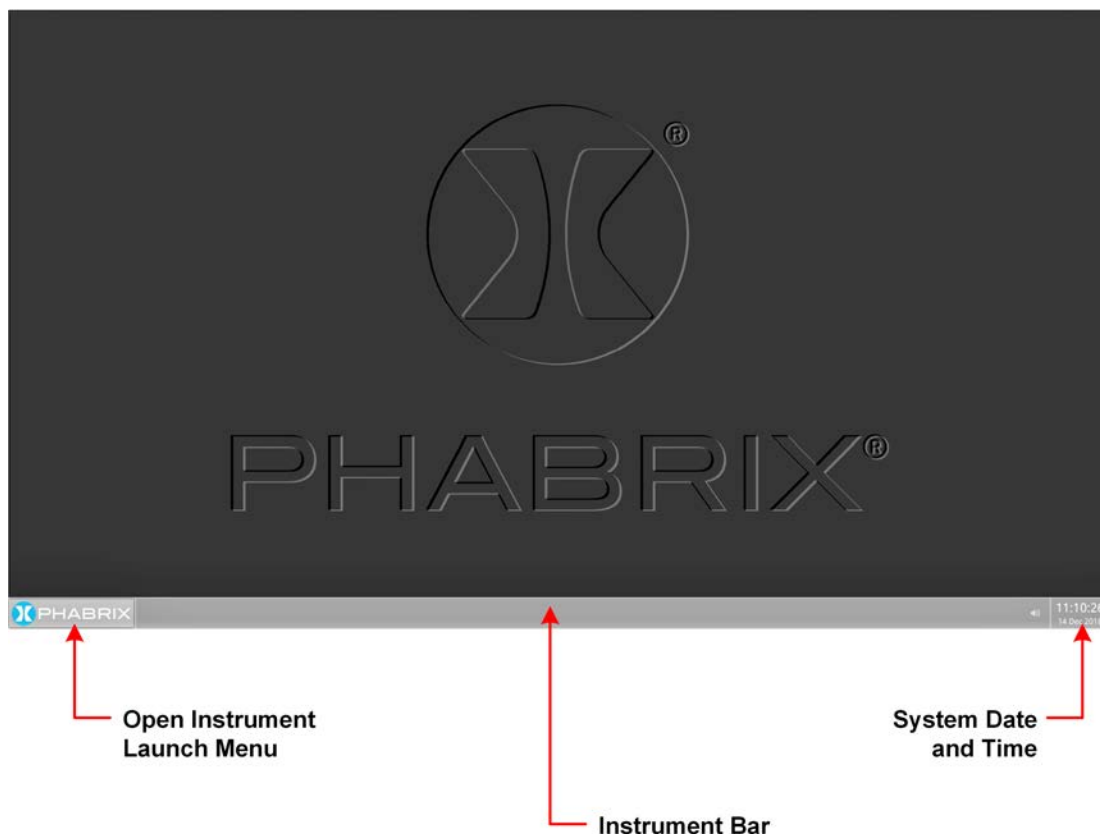

Figure 2-1: Initial Qx Screen Following Start-up

The Instrument Launch Menu gives you access to all the test and measurement instruments available through your license(s).

To open the Instrument Launch Menu, click the PHABRIX button in the bottom-left corner of the **Instrument Bar**.



Figure 2-2: PHABRIX Button to Open the Instrument Launch Menu

Using the Instrument Launch Menu

The Instrument Launch Menu provides access to the test and measurement Instruments and other system menus available with your unit. Open the Instrument Launch Menu by clicking the PHABRIX button in the bottom-left corner of the screen.

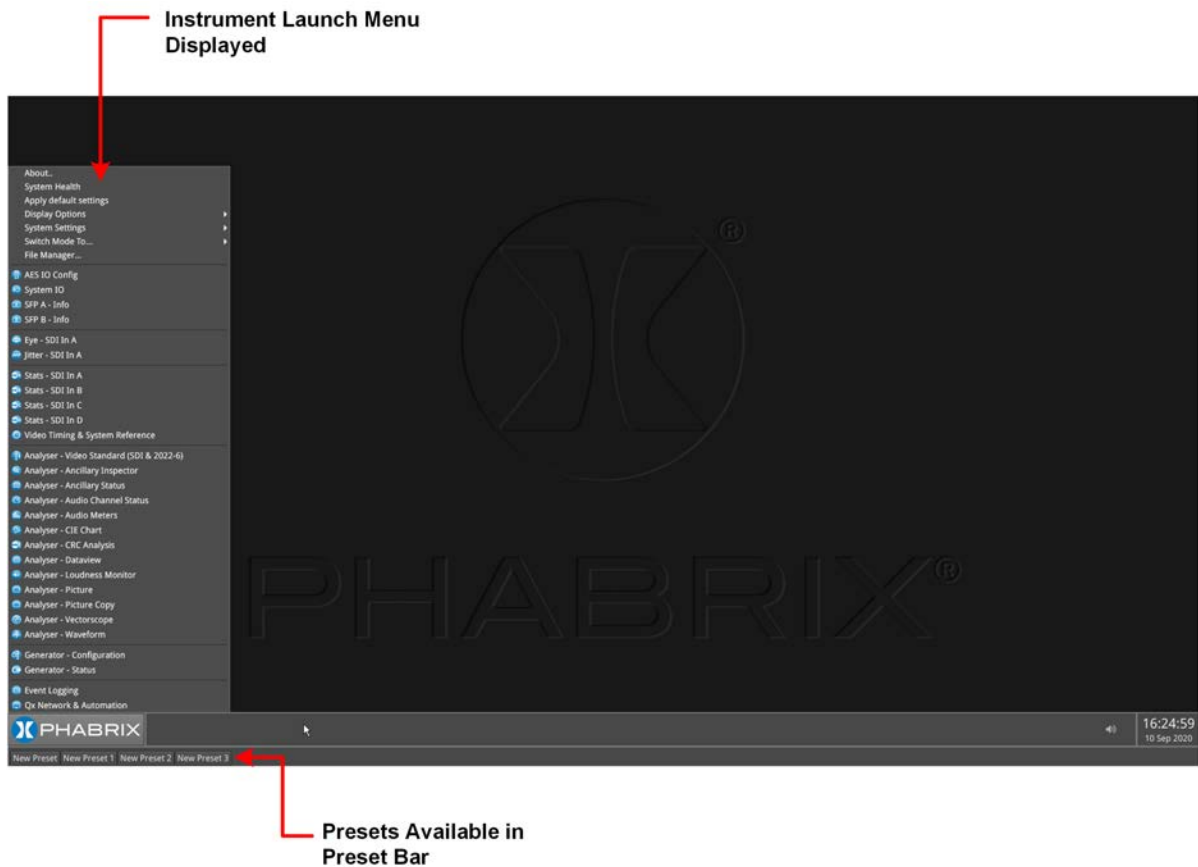

Figure 2-3: Open Launch Menu

The Qx includes four possible boot modes and each boot mode includes a different combination of options in the Instrument Launch Menu. For more information on the different boot modes, see the section: ["Switching Between Boot Modes" on page 3-11.](#)

On start up, you will see the following SDI Instrument Launch Menu, displayed by default:

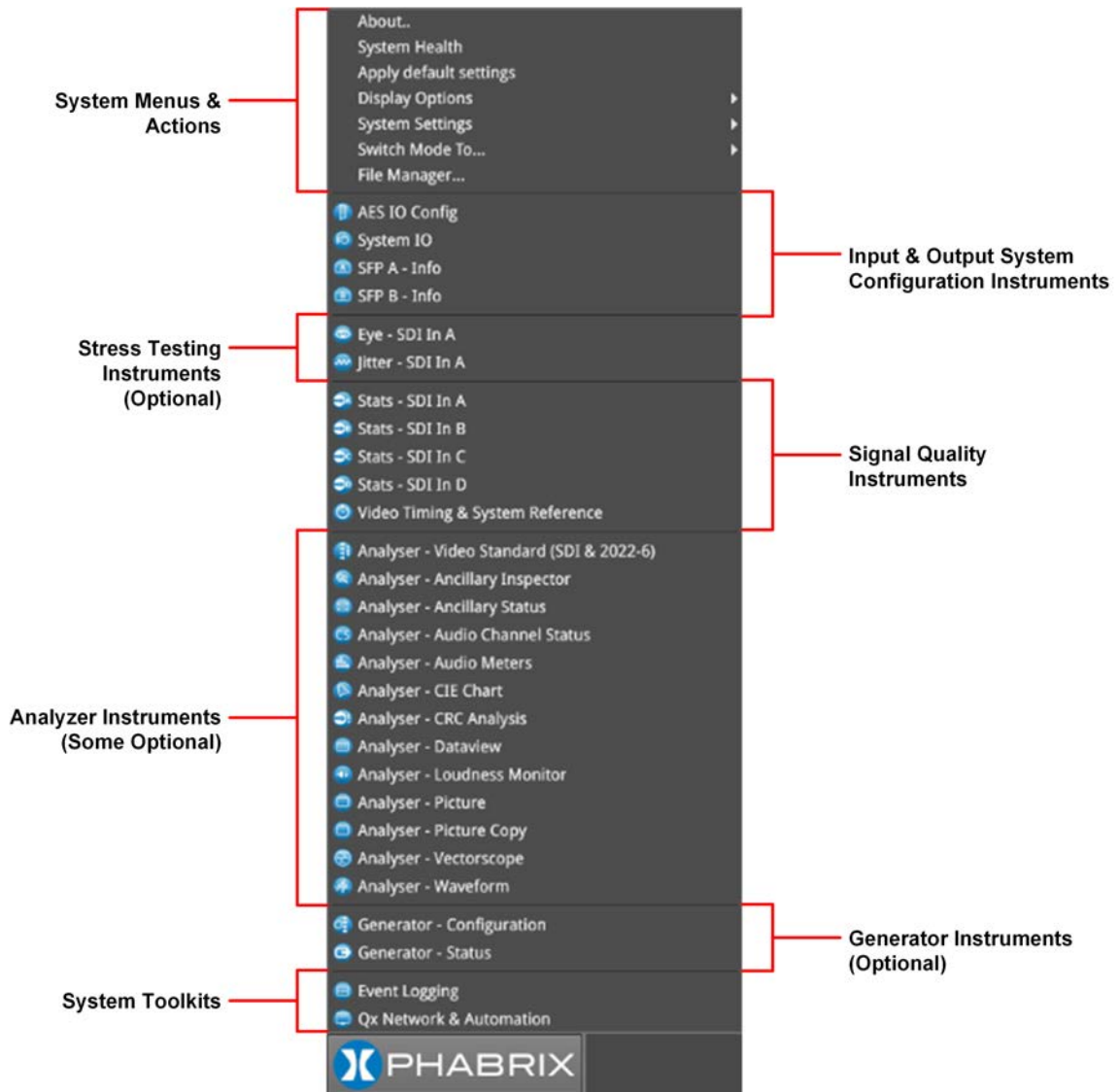

Figure 2-4: Qx Launch Menu in SDI Boot Mode

Each Instrument available in the menu is listed alongside its designated icon. Options listed at the top of the menu, without icons, provide access to system menus and actions, such as switching the boot mode or reverting to default settings.

When you select an instrument from the Instrument Launch menu, the Instrument window opens and its icon is displayed in the Instrument Bar at the bottom of the screen.

As you select each new instrument, the Qx adds another icon to the Instrument Bar.



Figure 2-5: Qx Instrument Bar Showing Icons for Active Instruments

Using the Instrument Bar

As you open an Instrument from the Instrument Launch Menu, the Qx adds the corresponding icon for that Instrument to the Instrument Bar. To identify the Instrument corresponding to an icon, simply hover the mouse over the icon and the unit displays a tooltip showing the name of that Instrument.

You can use the Instrument icons to bring a particular Instrument window into focus, a useful feature if you have a number of Instruments overlapping on the display. On finishing with an Instrument, right-click its icon and select the option **Close "Instrument Name"**.

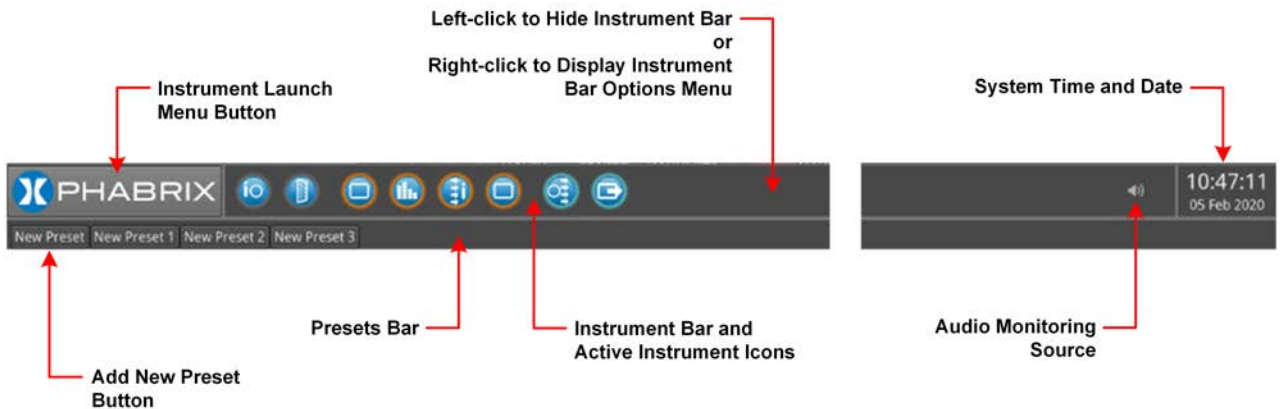

Figure 2-6: Key Components of the Instrument Bar

To give Instruments in the lower part of the display more screen space, you can hide the Instrument Bar by left-clicking in any of the blank sections of the Bar. Move the cursor back to the bottom of the screen, at any time, to redisplay the Instrument Bar.

In addition, the unit displays any configuration presets you define in a **Presets Bar**, below the Instrument Bar, depending on the setting of the option **Auto-hide Presets** in the Instrument Bar Options menu. For more information on saving Presets, see ["Using System State Presets and the Preset Bar" on page 2-12](#)

Using the Instrument Bar Options Menu

Further options to control the Instrument and Preset bars are available by right-clicking in the Instrument Bar to display the **Instrument Bar Options** menu, shown below:

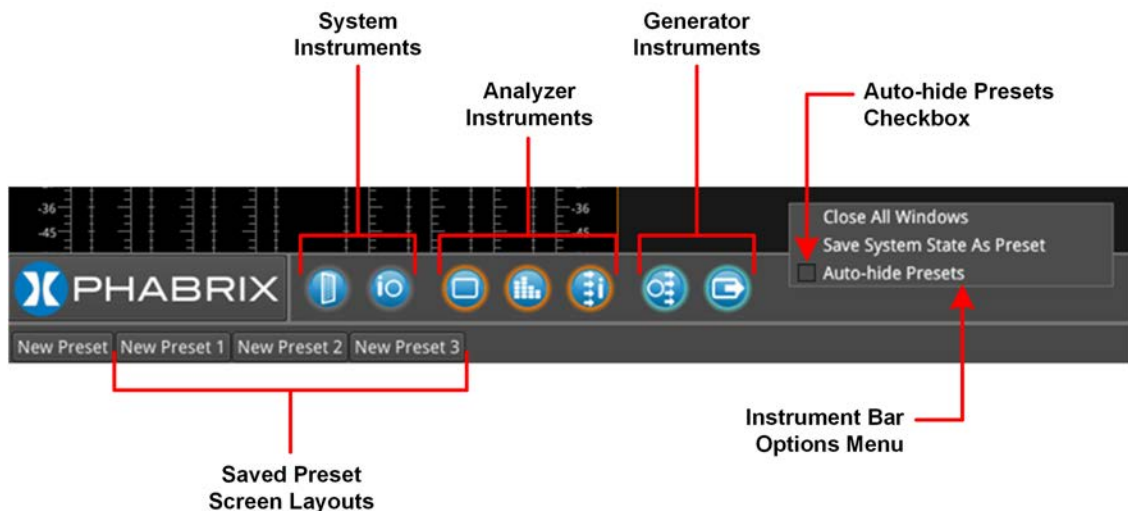

Figure 2-7: Instrument Bar Options Menu

You can close all Instrument windows together by right-clicking the Instrument Bar and selecting the option **Close All Windows** from the menu.

When the **Auto-hide Presets** checkbox in the Options menu is selected, the Presets bar remains hidden when the Instrument Bar is active. To view any saved Presets, uncheck the **Auto-hide Presets** checkbox. For more information on saving system Presets, see the section: ["Using System State Presets and the Preset Bar" on page 2-12](#).

Controlling the Audio Monitoring Source

An icon to control the Audio Monitoring Source is displayed at the right-hand side of the Instrument Bar, before the time and date display. The audio monitoring icon controls the audio monitoring output of the unit, whether monitoring over HDMI, SDI instrument monitor output, or 26-way D-type. Click once to mute or unmute the audio monitoring source.

The audio monitoring source icon changes to display the current status of the audio source as shown in the following table:

Table 2-1: Audio Source Monitoring Icon States

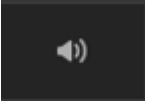
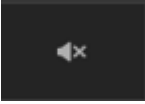
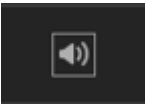
Audio Icon State	Description
	Standard state, audio source active (unmuted).
	Audio source muted (inactive).
	Audio source active (unmuted) with volume slider control displayed.

Hover over the audio icon to display a tooltip showing the current audio Source channel/pair selected.

To adjust the volume of the audio monitoring source, right-click the Audio icon to display a sliding volume control. Drag the slider left or right to adjust the volume of the audio monitoring source as required.

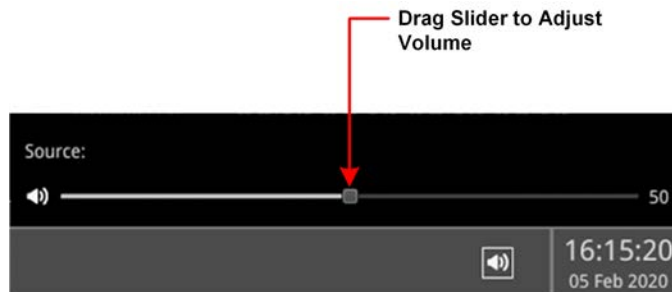

Figure 2-8: Adjusting the Volume of the Audio Monitoring Source

Use the **Analyzer - Audio Meters** Instrument to select the target audio monitoring source.

System Time and Date Display

The system date and time are displayed in the bottom-right corner of the screen.

To modify the system time and/or date, right-click in the time and date display. This displays a button with the following message:

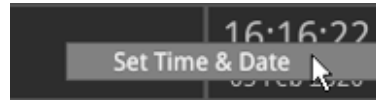

Figure 2-9: Accessing the Time and Date Adjustment Dialog

Click the **Set Time & Date** button to open the Time and Date dialog. For more information on setting the system time and date, see the section: ["Setting the Time, Date and NTP Server" on page 3-5](#)

Using System State Presets and the Preset Bar

Note: It is not possible to transfer System State Presets from a Qx to a QxL unit as they will not be recognized.

Whenever you work with the Qx, you can save your current screen layout and settings as an Instrument **Preset** for ease-of-use and convenience. If you decide to start a different task, you can launch a Preset from the Preset Bar with a single click, rather than opening and adjusting individual Instruments.

You can save multiple Presets as required, giving you a library of bespoke layouts tailored to specific operational tasks. The unit saves each Preset to the **Preset Bar**, located below the Instrument Bar, and automatically labels each Preset sequentially as New Preset 1, New Preset 2, etc.

Once you have organized the display with your required Instruments, save as a Preset by right-clicking the Instrument Bar and selecting the option **Save System State As Preset** from the menu.

A saved system state Preset saves the following items:

- Layout of currently active Instruments
- All user-defined settings in the active Instruments.
- All user-defined System settings, for example, Display Brightness.

On saving a Preset, the Preset Bar opens below the Instrument Bar, with the current screen layout saved with the default name **New Preset n**.

To rename a Preset, right-click the preset name and select the option **Rename Preset**. The Preset Rename dialog is displayed, enabling you to rename the Preset using a connected USB keyboard.



Figure 2-10: Preset Options Menu



Figure 2-11: Rename Preset Dialog

Note: An on-screen keyboard is not provided in this software version.

To save other layout Presets, organize the display as required, and repeat as above.

To delete a Preset, right-click the Preset, select the option **Delete Preset** and confirm the deletion. If you no longer wish to delete the preset, select Cancel.

To hide the Preset bar automatically from view, right-click the Instrument Bar or Preset Bar and check the **Auto-hide Presets** checkbox. To display the Preset Bar, uncheck the checkbox.

Overview of the Instrument Windows

Each Qx Instrument window border and its corresponding icon is assigned a color and the icon and Instrument border are displayed in the assigned color to indicate that it is part of one of the following *groups* of Instruments:

- **System:** Instruments used to configure various elements of the Qx system. Default border color: white.
- **Analyzers:** Instruments used to analyze characteristics of the video signal and its associated components. Default border color: orange.
- **Generators:** Instruments used to generate a video or audio signal. Default border color: cyan.

The color-coding provides easy identification of the Instrument type. You can enable/disable the Instrument borders or modify the assigned color in the Display Options submenu, selected from the Instrument Launch Menu. For more information on setting-up the display, see the section: ["Setting-up the Display" on page 3-6](#).

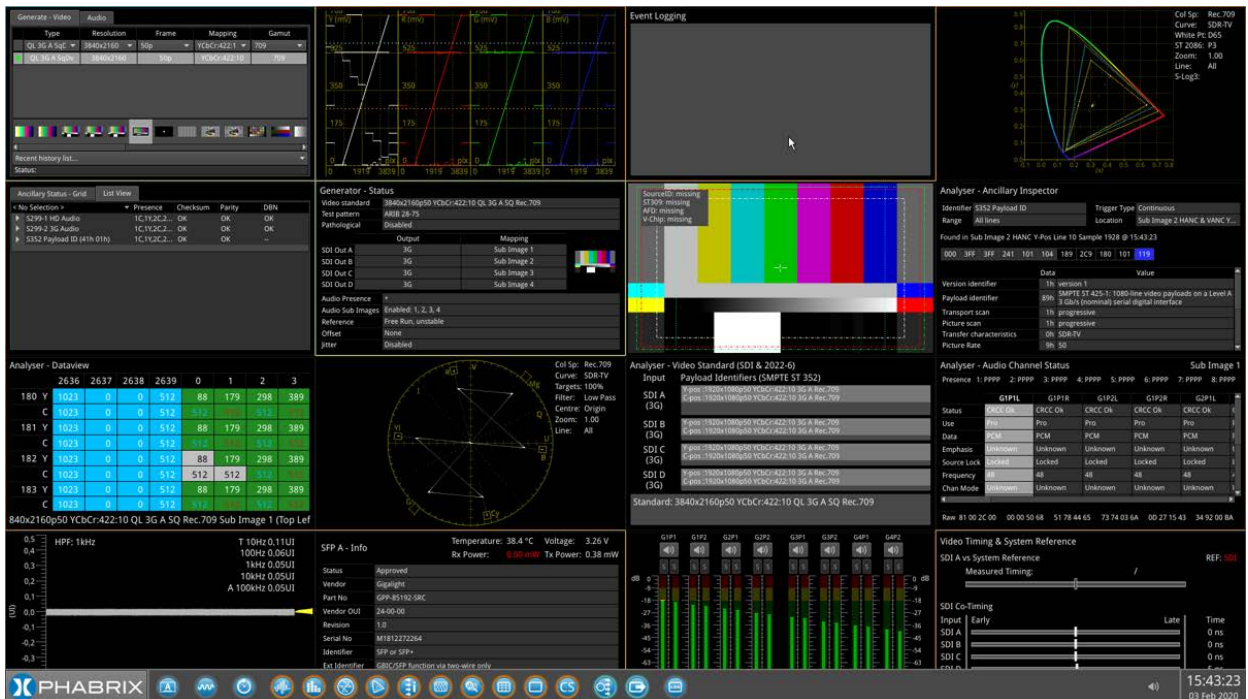

Figure 2-12: Full Screen with Active Instruments

Changing the Border Color of Instrument Windows

If desired, you can change the border color of Analyzer and Generator Instruments as described in the Section: ["Setting-up the Display" on page 3-6](#).

Note: The borders and icons of System Instruments are always colored white.

Instrument borders automatically merge by group color. If you position one Analyzer instrument, for example, next to another Analyzer, then the border will outline all instruments in the common group, in contact with each other, to aid group recognition.

In addition, signal connectors displayed in an instrument window (for example, in the System IO instrument) are displayed in the Analyzer color to indicate an input or the Generator color to indicate an output, when they are active.

Working with the Qx Instruments

Each Qx Instrument includes a pop-up submenu, displayed by right-clicking the mouse in the window, which gives you access to the configuration parameters of that Instrument.

Once open, you can move the submenu to any position on the screen by clicking the gray bar at the top of the menu and dragging it to a new position.

In addition to listing the Instrument-specific parameters, the submenus include the following operational commands:

- **Take Screenshot:** Saves an image of the current active display to the unit's SSD storage.
- **Dismiss Menu:** Closes the submenu.
- **Close "Instrument":** Closes the Instrument, removing it from the display.

The following figure shows an example of a pop-up submenu displayed by right-clicking in the **Eye - SDI In A** Instrument:

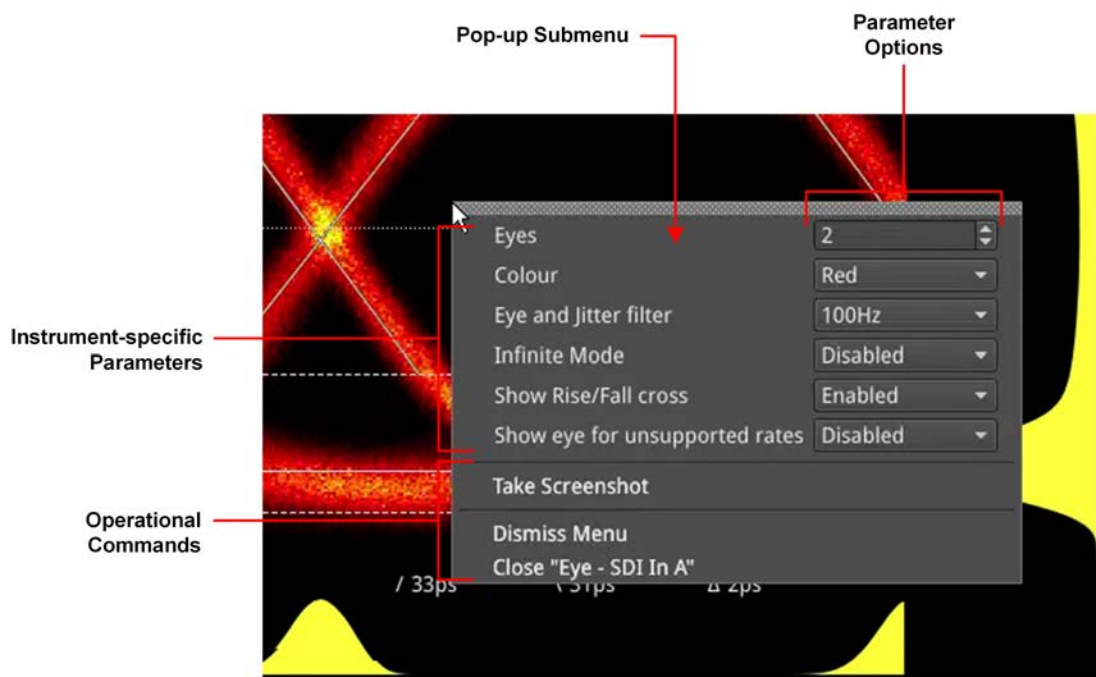

Figure 2-13: Instrument Pop-up Submenu Displayed

Other dialog windows (About, False Color Ranges, Driver Calibration, etc.) also include right-click menus with options to take a screenshot, dismiss the menu, and close the dialog window.

Selecting Submenu Options and Entering Values

You can select most options in the Instrument submenus by selecting one of the options in a dropdown listbox. For example, you might enable or disable a parameter by selecting Enable or Disable from the dropdown list.

Other parameters require you to enter a numeric value, for example, the number of Eyes displayed in the **Eye - SDI In A** Instrument, or the zoom factor in the **Analyzer - Vectorscope** Instrument.

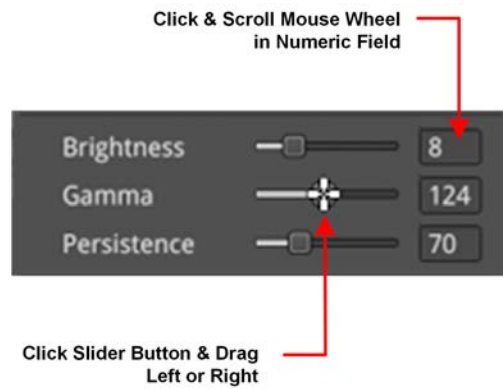

Figure 2-14: Adjusting Numeric Values in the Analyzer - Vectorscope Instrument

You can adjust a numeric value using one of the following methods:

- Click the slider button and drag left or right to decrease or increase the value, respectively.
- Click the cursor in the numeric field and scroll the mouse wheel backward or forward to decrease or increase the value, respectively.
- Connect a USB keyboard to the unit, click in the numeric field and enter the new value using the keyboard.

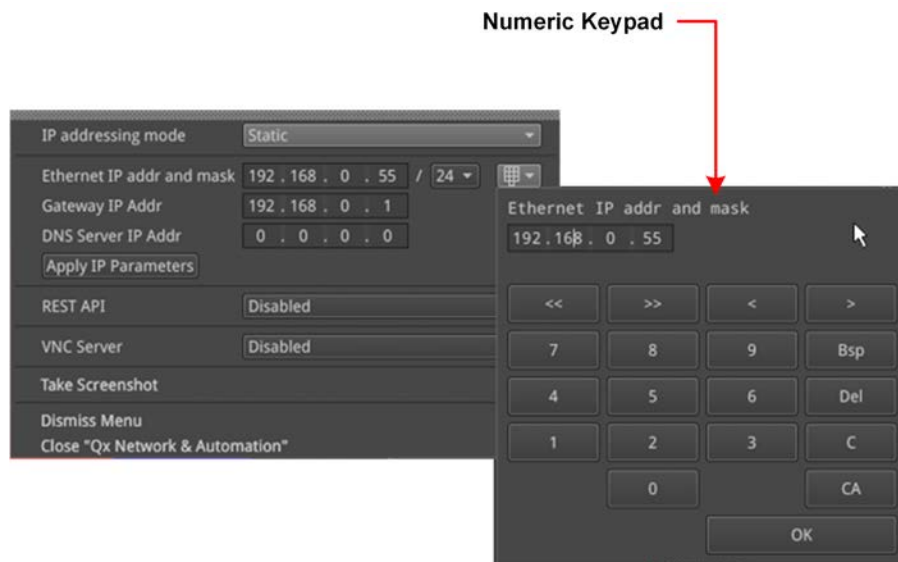

Figure 2-15: Manual Entry of a Static IP Address in the Qx Network & Automation Instrument

One further method to enter numeric data is encountered when you choose to enter a static IP address manually into the unit using the **Qx Network & Automation** Instrument.

If you select the IP addressing mode Static from the dropdown list, the unit displays a numeric keypad. To enter an IP address, simply click the numbers on the keypad, then click OK to save the address.

Resizing an Instrument Window

Double-click in any Instrument window to cycle through a set of standard instrument window sizes.

In many cases, you can manually adjust the size of a window further to suit your requirements. To do so, hover the cursor over either the right-hand or bottom borders until a double-headed arrow is displayed, then drag the border until the Instrument reaches the desired width or height.

Using the Instrument Scroll Bars and Scroll Control Menu

For those Instruments displaying a large amount of data, vertical and horizontal scroll bars are provided to help navigate through the data. A scroll control menu, accessed by right-clicking the scroll bar provides further scrolling or paging options.

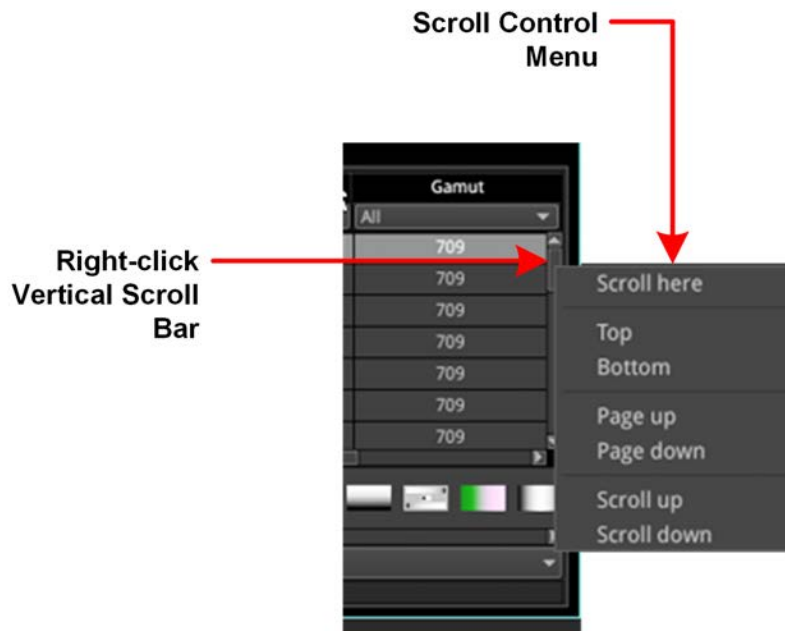

Figure 2-16: Instrument Scroll Bar Control Menu

Taking Screenshots

Note: Before taking a screenshot, first disable VNC in the submenu of the **Network & Automation** Instrument and set the display brightness to its maximum setting using the Display Options in the Launch menu.

To capture an image of the entire display, open an Instrument submenu and simply select **Take Screenshot**. The image is saved to the SSD as a portable network graphic (.PNG) format file. Alternatively, connect a USB keyboard to the unit and press **[Shift] + [PrtScn]** to capture the display. You can retrieve your saved screenshots, in PNG format, from the SSD using the USB File Manager or a remote connection method, as required. For more information on retrieving the file from the unit, see the section ["Managing Files with the USB File Manager" on page 3-19](#).

Working with Instrument Tabs

Some of the Qx configuration Instruments feature tabs along the top of the window which provide quick and easy access to different functional groups within a single Instrument.

The Instrument submenus are reserved for auxiliary settings relating to each available tab.

The following figure shows the **Generator - Configuration** Instrument, which includes a tab for video generation and a separate tab for audio generation.

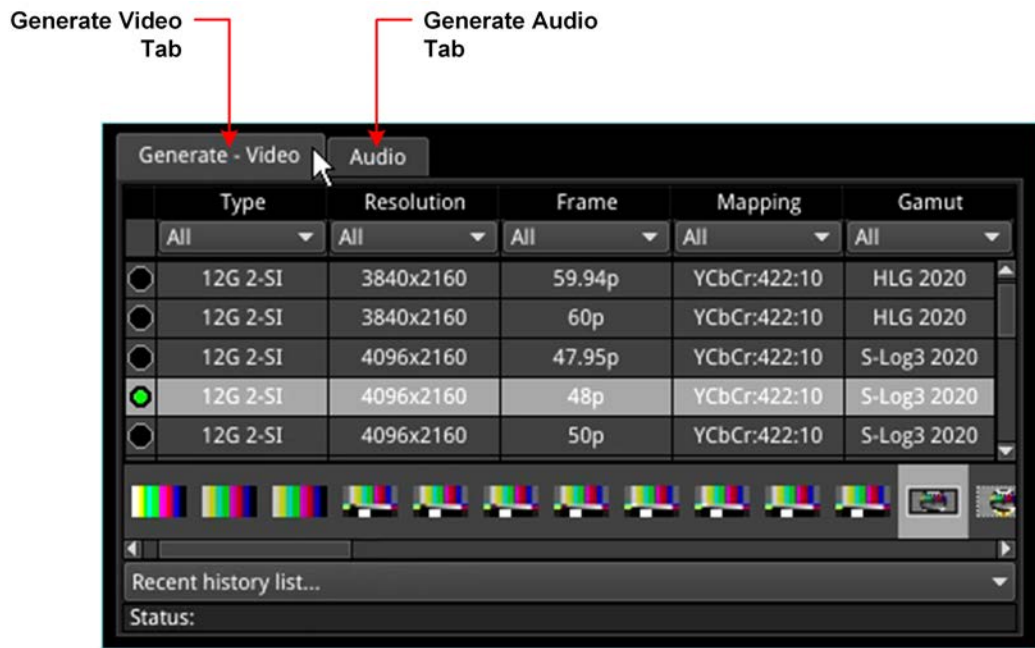

Figure 2-17: Example of Tabs in the Generator - Configuration Instrument

The unit also uses tabs to present alternative displays of analyzed data. For example, the **Analyzer - Ancillary Status** Instrument, provides tabs that enable you to switch between the Grid or List data views.

Instrument Icon Quick Reference

The icons shown below each represent a different Instrument (some optional) and are displayed in the Instrument Bar when the corresponding Instrument is active.

	AES IO Config		Analyzer - CIE Chart
	System IO		Analyzer - CRC Analysis
	SFP A - Info		Analyzer - Data View
	SFP B - Info		Analyzer - Picture / Analyzer - Picture Copy
	Eye - SDI in A		Analyzer - Vectorscope
	Jitter SDI in A		Analyzer - Waveform
	PRBS Analysis		Generator - Configuration
	Stats - SDI in A		Generator - Status
	Stats - SDI in B		Event Logging
	Stats - SDI in C		Qx Network & Automation
	Stats - SDI in D		SFP A - Network Stats
	Video Timing & System Reference		SFP B - Network Stats
	Analyzer - Video Standard (SDI & 2022-6)		IP Receive - Flow Select
	Analyzer - Ancillary Inspector		IP Receive - Interpacket Timing
	Analyzer - Ancillary Status		Stats - IP Receive (SFP A)
	Analyzer - Audio Channel Status		IP Transmit (SFP B)
	Analyzer - Audio Meters		SFP IP Network
	SFP A / B - PTP Info		Analyzer - 2110 Format Setup
	Analyzer - 2022-7 Status		Analyzer - LLDP Data
	Analyzer - 2110-21 Status		IP Receive - NMOS
	Analyzer - Loudness Monitor		

Configuring and Checking the Unit

This chapter describes how to set-up some fundamental parameters and check that the unit is working correctly; it includes the following sections:

- [Qx Network and Automation](#)
- [Setting the Time and NTP Server](#)
- [Setting-up the Display](#)
- [Checking the Unit](#)
 - [Checking the System Health Status](#)
 - [Checking the Licenses](#)
 - [Restarting the Unit](#)
 - [Reverting to Factory Default Settings](#)
- [Switching Boot Modes](#)
- [Resetting the SFP Configuration Database](#)
- [Upgrading the Software, Firmware and Options](#)
- [Managing Files with the USB File Manager](#)
- [Event Logging on the Unit](#)
- [Remote Connection to the Unit](#)



Overview

The **Qx Network & Automation** Instrument provides all the control network information and facilities you need to connect remotely to the unit and control its interface.

Once the unit is powered on and an RJ45 connector connected to the management port, you can access the unit remotely and set its date and time from an NTP server.

You can control the unit remotely using a number of methods, including:

- Virtual Network Computing (VNC)
- REST API (for automated testing).

Qx Network & Automation	
Interface	Up
MAC Address	00:1F:7F:00:50:01
IP Addressing Mode	Dynamic
IP Address	192.168.0.110
Gateway	192.168.0.1
DNS Server	192.168.0.10
mDNS Server	qx-020481.local
REST API	Listening on port 8080
VNC Server	Disabled

Figure 3-1: Qx Network & Automation Instrument

Using VNC to Connect Remotely to the Unit

Make a remote connection to the unit using Virtual Network Computing (VNC), as follows:

1. From the Instrument Launch menu, open the Instrument **Qx Network & Automation** and right-click to open the submenu.
2. For the option **VNC Server** select **Enabled**.
This enables the VNC server on the unit. The Network & Automation instrument displays the number of current VNC server connections.
3. Install a VNC client viewer of your choice on the remote PC and launch the viewer.
4. Initiate a connection to the unit by entering the IP address of the unit (displayed in the **Qx Network & Automation** instrument) or its mDNS Hostname (if mDNS is enabled on your computer.)
5. When required, enter the password: **phabrixqx**
A view of the Qx desktop will open on your computer screen. You can now control the unit with your local mouse and keyboard. You should see that the number of current VNC server connections displayed in the Network & Automation instrument has increased by one.

You can now set the unit's date and time to that of an NTP server as described in the section: ["Setting the Time, Date and NTP Server" on page 3-5](#).

Note: Remote monitoring of the audio output from the unit is not available over VNC.

Instrument Menu Options

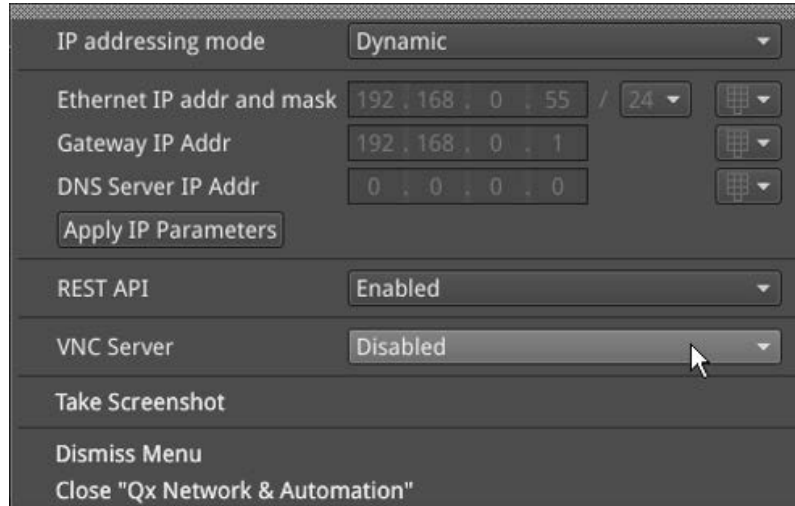

Figure 3-2: Qx Network & Automation Instrument Menu Options

The following table lists the options available in the Qx Network & Automation instrument submenu:

Table 3-1: Qx Network & Automation Menu Options

Item	Options	Description
IP addressing mode	Dynamic Static	For remote access to the unit, you can assign the IP address of the unit either dynamically, on a DHCP enabled network, or specify a static IP address manually. When assigned dynamically using DHCP, the following IP address fields are automatically populated and cannot be edited.
Ethernet IP addr and mask	Enter static IP address and mask (range: 8 to 31) as required.	Only active when the static IP addressing mode is selected. Use the dropdown list to select the Mask. The unit uses CIDR notation; with a default value of /24. Use either a USB keyboard or click the keypad icon to enter the address using the numeric keypad.
Gateway IP Addr	Enter the IP address of the Gateway as required.	Only active when the static IP addressing mode is selected. Use either a USB keyboard or click the keypad icon to enter the address using the numeric keypad.
DNS Server IP Addr	Enter the IP address of the DNS Server.	Only active when the static IP addressing mode is selected. Use either a USB keyboard or click the keypad icon to enter the address using the numeric keypad. After entering all required static IP parameters, click Apply IP Parameters .
REST API	Enabled Disabled (Default)	When enabled allows remote connection to the unit using the REST API. The Qx Network & Automation window contains all the information on the unit required to submit a REST request. It is recommended to use the IP Address (or mDNS Hostname if your client's host supports it) as the recipient of the request, and the REST API Port is the port towards which requests need to be directed. The REST API supports four HTTP methods: GET, PUT, DELETE, and POST. Use GET requests to retrieve information and navigate the submenus and PUT requests to modify and con-

Item	Options	Description
		<p>Control the unit's behavior and actions. Use a web browser to retrieve information from the unit using GET requests. You can use any HTTP/1.1 compliant application to control the unit using GET and PUT requests. In addition, PUT, GET, DELETE, and POST requests can be scripted for automated testing.</p>
VNC Server	Enabled Disabled (Default)	<p>When enabled allows remote connection to the unit from a VNC client viewer. The VNC Server setting in the Network & Automation window shows the number of current VNC connections to the unit. Once a connection is made, or ended, this number is automatically updated.</p>

Note: The mDNS Hostname has the following case-sensitive syntax: **qx-*<serial number>*.local**. For example: qx-123456.local

Setting the Time, Date and NTP Server

The Qx displays the system date and time in the bottom-right corner of the screen.



Figure 3-3: Date and Time Display

You can configure the unit to use a date and time transmitted by a target Network Time Protocol (NTP) server or set the time and date manually in the Time and Date dialog.

Configure the date and time as follows:

1. Right-click on the time/date display in the bottom-right corner of the screen.
2. Select: **Set Time & Date**.
This opens the Time and Date dialog.

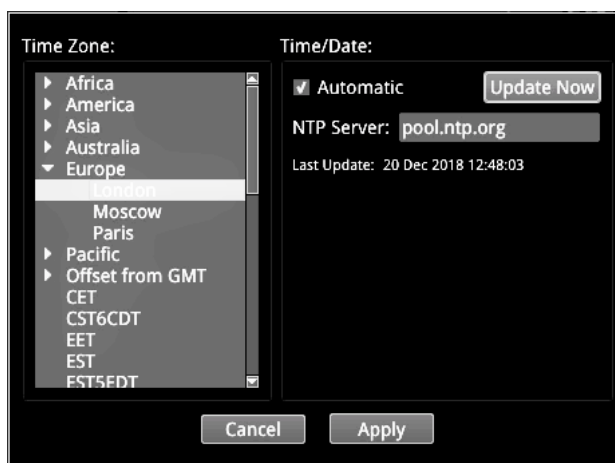

Figure 3-4: Time and Date Dialog

3. To use the automatic time and date from an NTP server:
 - a. Select the **Automatic** checkbox.
 - b. Enter the address of the NTP Server using a USB keyboard.
For example: **pool.ntp.org**
 - c. Select your local time zone from the **Time Zone** list box.
 - d. Click **Update Now** and confirm that you are happy with the updated settings.
 - e. Click **Apply** to save your changes and quit the dialog.
To discard your changes, click **Cancel**
4. To set a time and date for the unit manually:
 - a. De-select the **Automatic** checkbox.
This displays the manual date and time fields.

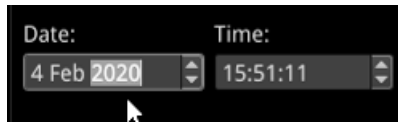

Figure 3-5: Manual Date and Time Fields

- b. Adjust the date and time by clicking the target item and either increase or decrease the setting using the mouse scroll wheel or the up/down arrow buttons at the right of the fields.
- c. Click **Apply** to save your changes and quit the dialog.
To discard your changes, click **Cancel**

Setting-up the Display

Modifying the Display Options

The unit's Display options enable you to set the display brightness and output frame rate, or modify the appearance of the Instrument windows on the screen.

Configure the display to which the unit is connected as follows:

1. Click the PHABRIX button to open the Instrument Launch menu.
2. Select: **Display Options**.
This opens a submenu listing the configurable display options.

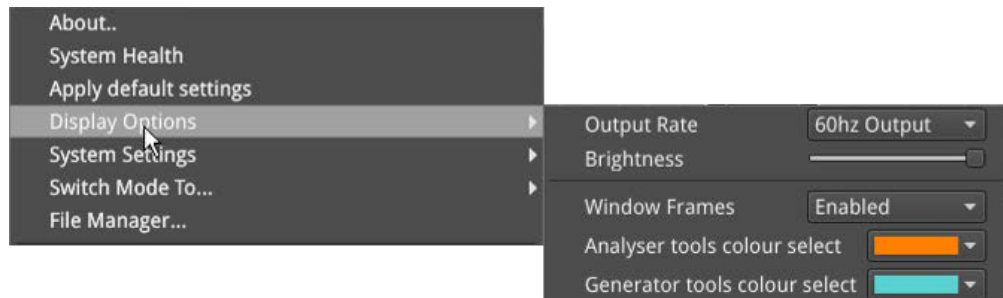

Figure 3-6: Display Options in Instrument Launch Menu

3. Select the desired frame rate from the **Output Rate** dropdown list:
 - 50 Hz
 - 59.94 Hz
 - 60 Hz
4. Drag the **Brightness** slider left or right to decrease or increase the display brightness to a comfortable level.

Note: When using the Screenshot function to capture the display, it is recommended to set the brightness to the maximum setting to increase the clarity of the saved image.

5. Choose whether to display a border around the Instruments by enabling or disabling the option **Window Frames**.
When disabled, you switch off the border color differentiation between Analyzer and Generator Instruments.

6. When the option **Window Frames** is **Enabled**, you can change the border color of Analyzer or Generator instruments as follows:
 - a. Select the dropdown color selector corresponding either to the Analyzer or Generator. This opens the Hue, Saturation, Value (HSV) tool shown below.

Note: The borders and icons of System Instruments are always colored white.

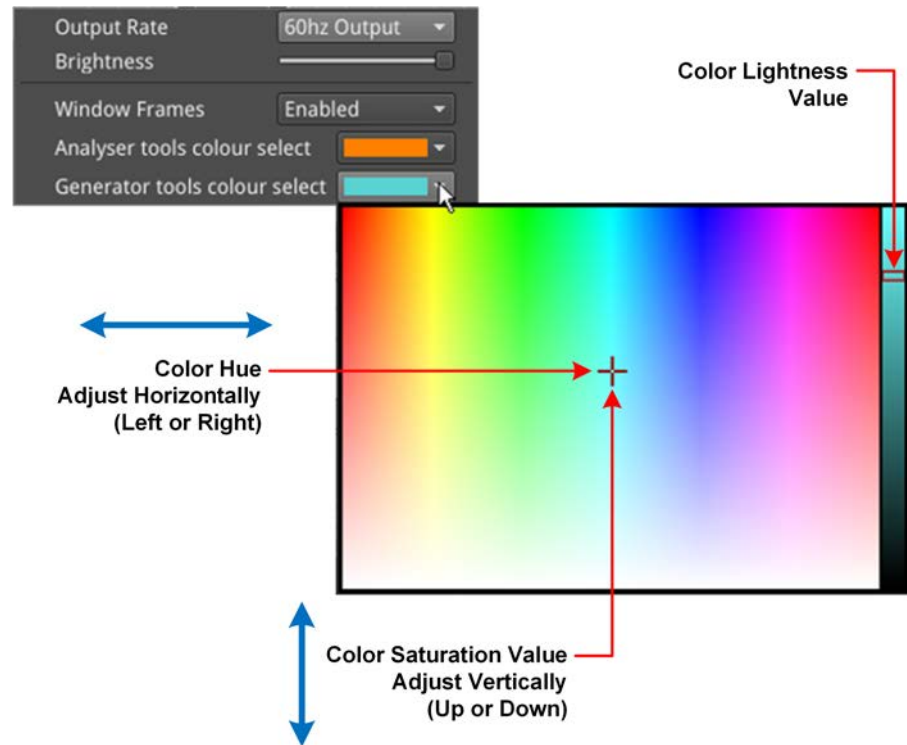

Figure 3-7: Selecting Analyzer and Generator Border Colors in the HSV Window

- b. Click at a point in the left-hand color box of the HSV tool to select the hue (horizontal) and saturation (vertical) settings of the new border color.
 - c. Click at a point in the right-hand vertical bar to select the color lightness value. This will change the displayed borders of all Instruments of that type.
 - d. Repeat the previous steps for the second Instrument type, if desired.
 - e. Close the HSV menu.
7. Click anywhere outside the menus to quit and save your new display settings.

Checking the Unit

Overview

Your Qx unit should now be powered on in the default boot mode (SDI), with the correct date and time showing, and at least the basic screen displayed with any of your modifications. At this point you should confirm that the unit is healthy and running correctly, as expected, by checking the following:

- System Health
- Licensing and ordered licensed options
- Software and firmware versions

These items are described in the following sections.

Checking the System Health Status

You can check the current health status of the unit in the **System Health** dialog as follows:

1. Click the PHABRIX button to open the Instrument Launch menu.
2. Select: **System Health**.
This opens the System Health dialog displaying the current hardware health of the unit, including: CPU and FPGA temperature, voltage (DDR and 5.5 V), and cooling fan revolutions.

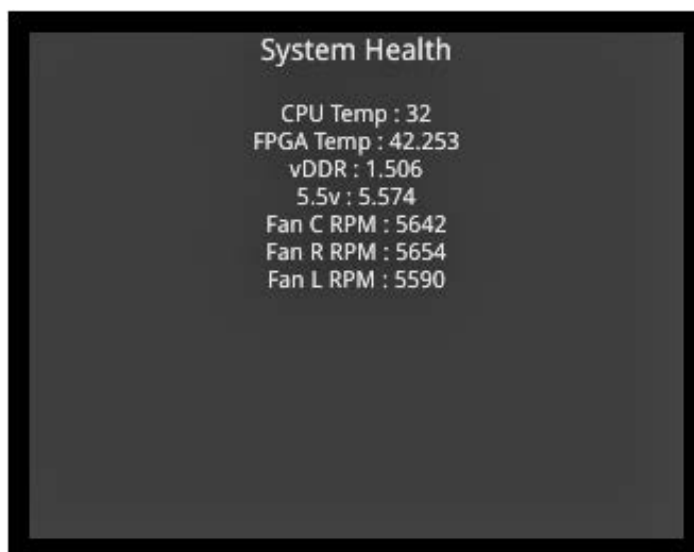

Figure 3-8: System Health Information

Table 3-2 : System Health Recommended Thresholds

Item	Safe Range	Description
CPU Temperature	From 0° to 85°C	Unit will issue a high temperature warning at 80°C and switch off at 85°C
FPGA Temperature	From 0° to 85°C	Unit will issue a high temperature warning at 80°C and switch off at 85°C
5.5 V	5.030 to 5.734 V	Hardware switches off the unit if the voltage moves outside the safe range.

Item	Safe Range	Description
DDR Voltage	1.283 to 1.580 V	Hardware switches off the unit if the voltage moves outside the safe range.
Cooling Fans	3000 to 9500 rpm	Speed of fans varies with the temperature of the unit. Three cooling fans are located in the front of the unit - in left (L), center (C) and right (R) positions.

Checking the Unit Licenses

It is important at this point to confirm that your unit has been shipped with the software options and corresponding licenses documented in your original order.

Check the licensing details and other system information in the **About** dialog as follows:

1. Click the PHABRIX button to open the Instrument Launch menu.
2. Select: **About**.

This opens the About dialog listing detailed information about the system, including:

- Software version and build
- Serial number
- License details
- Build ID
- Mezzanine ID
- FPGA details
- Calibration details.

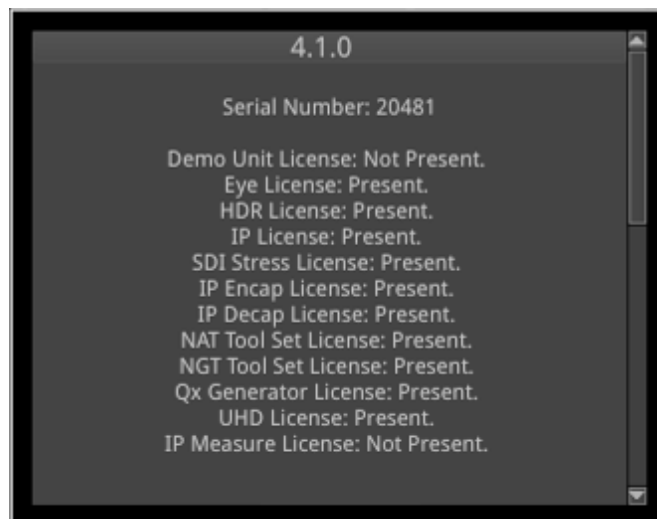

Figure 3-9: Serial Number and License Information

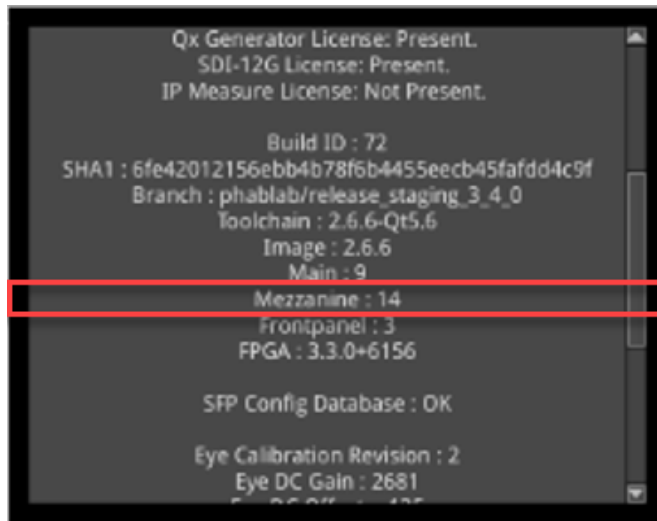

Figure 3-10: Mezzanine ID in About Dialog

Restarting the Unit

If at any time you want to restart the unit, you can do so from the System Settings options, accessed from the Instrument Launch menu, without powering-down the unit.

Restart the unit as follows:

1. Click the PHABRIX button to open the Instrument Launch menu.
2. Select: **System Settings**.



Figure 3-11: System Settings Option Menu

3. Select: **Restart Qx**.
 This opens a Restart confirmation dialog.

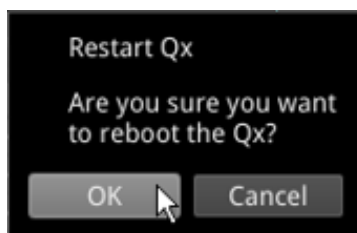

Figure 3-12: Display Options in Instrument Launch Menu

4. Click: **OK** to confirm the restart or **Cancel** to quit without restarting.
 When you confirm the restart, the unit immediately enters boot mode and displays its status using the LED behind the On switch.

Reverting to Factory Default Settings

If you make configuration changes to the unit which you would rather discard, you can restore the unit to the factory default settings at any time.

Restore the factory defaults as follows:

1. Click the PHABRIX button to open the Instrument Launch menu.
2. Select: **Apply Default Settings**.
This opens a confirmation dialog, shown below, where you are prompted to confirm your choice before the factory defaults are restored.

Note: If you restore the factory settings, all your Presets and other configuration changes will be removed from the unit. It is recommended first to copy all your saved Presets to a USB memory stick before restoring factory defaults.

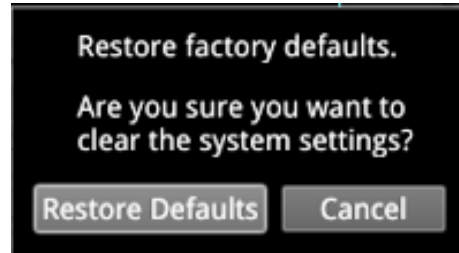

Figure 3-13: Confirmation to Restore Factory Default Settings

3. Click: **Restore Defaults** to confirm or **Cancel** to quit.

Switching Between Boot Modes

The unit includes four possible boot modes, with each boot mode featuring a different combination of options in the Instrument Launch Menu. The available firmware boot modes are as follows:

- 12G SDI Mode (Default boot mode)
- 12G SDI Stress Mode (optional)
- IP 2022-6 Mode (optional)
- IP 2110 Mode (optional), supporting:
 - SMPTE ST 2110 decapsulation (reception) of video (2110-20), audio (2110-30/2110-31), and ANC (2110-40) flows
 - SMPTE ST 2022-7 SIPS and dual ST 2059 (PTP)

On start up, you will see one of the following Instrument Launch Menus, depending on the boot mode and licenses applied to the unit:

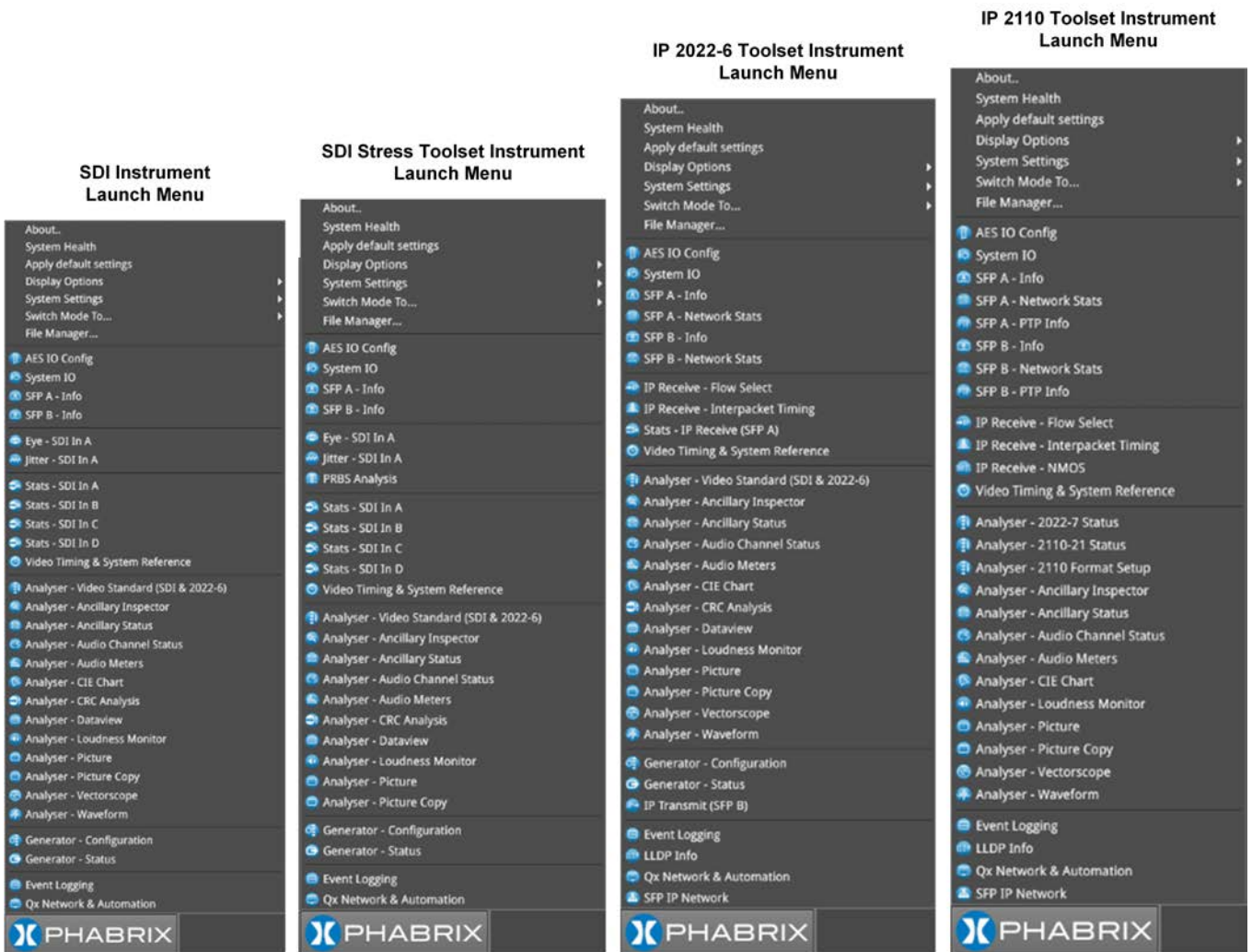

Figure 3-14: Qx Launch Menus for SDI (Default), SDI Stress, IP 2022-6, and IP 2110 Boot Modes

Each Instrument available in the menu is listed alongside its designated icon. Options listed at the top of the menu, without icons, provide access to System menus and actions, such as switching the boot mode or reverting to default settings.

When you select an instrument from the Instrument Launch menu, the Instrument window opens and its icon is displayed in the Instrument Bar at the bottom of the screen.

Depending on your product license(s), you can switch boot mode from the Instrument Launch menu.

Switch the Qx boot mode as follows:

1. Click the PHABRIX button to open the Instrument Launch menu.
2. Select: **Switch Mode To...**
This opens a submenu listing the available boot options.



Figure 3-15: Switching Between Qx Boot Modes

3. Select the desired option from the list (assuming that you are starting from the default SDI boot mode):
 - IP 2022-6
 - IP 2110

- SDI Stress Toolset
- In the **Switch Firmware** dialog displayed, click **Switch** to confirm the mode switch. Switching to a different boot mode can take about a minute to complete.



Figure 3-16: Qx Switch Firmware Dialog

- In the **Mode Configuration** dialog, select the checkbox **Reboot when complete** to reboot the Qx automatically into the new mode.

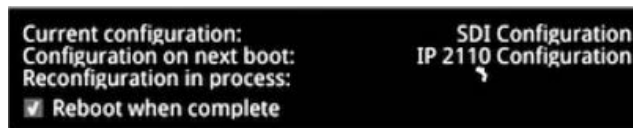

Figure 3-17: Qx Automatic Reboot Dialog

The Power Button light changes to a fixed yellow color (instead of white) once the reconfiguration request is complete, indicating that a mode switch request has been successful. The Qx unit restarts automatically in the requested mode.

- If you do not select the **Reboot when complete** checkbox as described above, the unit pauses on completing the mode reconfiguration and displays a Completion dialog featuring a **Reboot** button.

To continue with the mode switch, click **Reboot**.

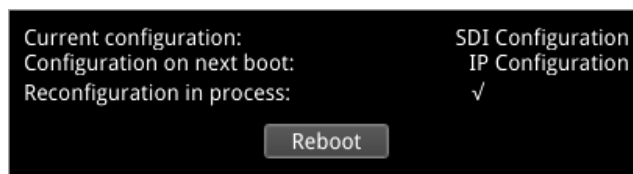

Figure 3-18: Qx Reconfiguration Dialog

Resetting the SFP Configuration Database

By default, the unit's SFP Configuration Database contains configuration details for the approved, factory supplied SFPs.

Note: If you have previously modified the SFP Configuration Database manually to include SFPs that were not approved, be sure to copy your current list from the unit *before* you reset the database values. By doing so, after reset, you can then add your user-defined SFPs to the database again if they are not automatically recognized by the unit. Contact PHABRIX Support for details on SFP configuration procedures.

Update the SFP Configuration Database with the latest standard list of PHABRIX approved SFPs for this software release as follows:

1. Click the PHABRIX button to open the Instrument Launch menu.
2. Select: **System Settings**.
3. Select: **SFP Configuration Database** from the submenu.



Figure 3-19: Resetting the SFP Configuration Database

4. Select: **Reset to Factory Values**.
5. Select **Reset** in the confirmation dialog.
You are warned that the database will revert to the factory defaults. Any user-defined SFP entries in the database will be deleted. To quit the reset process, select Cancel.

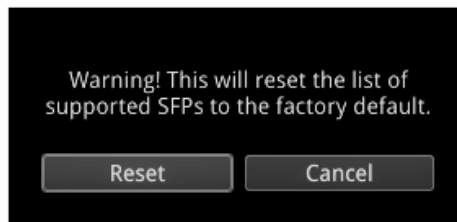

Figure 3-20: Resetting the SFP List to Factory Defaults

Note: If you have not previously modified the database, but have unsupported SFPs that you wish to use after reset, contact PHABRIX Support for information on how these might be added to the SFP database.

Upgrading the Unit

Upgrading the System Software and Firmware

New software releases will be made available regularly as the product is developed.

Software downloads are approximately 100 MB in size and can be found in the Support area of the PHABRIX website currently located at: <https://www.phabrix.com/support/product-software-downloads/>

1. Complete and submit the access request form.
2. Click the generated link to download the latest software.
3. Download the .ZIP file for the selected software release.

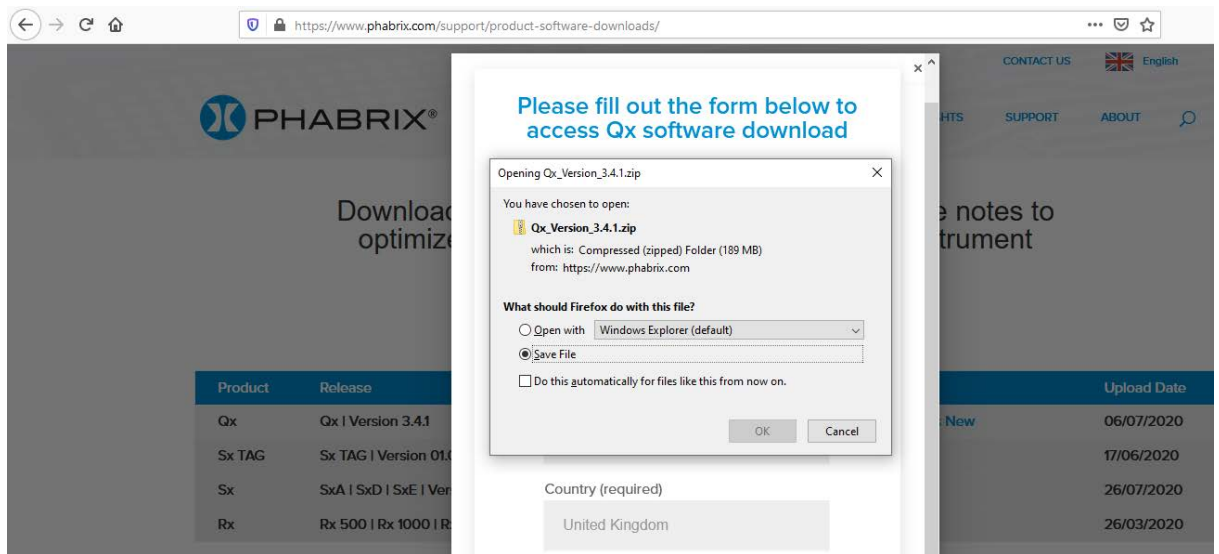

Figure 3-21: Downloading the Software Bundle from the PHABRIX Software Downloads Page

4. Extract and copy the file **phab_qx_upgrade.bin** to the root directory of a FAT32 formatted USB stick.

Note: Once you have upgraded your Qx to software version 4.1 using the .bin file, you will be able to install future updates using the downloaded .zip file.

5. Make sure that the unit is switched OFF before upgrading.
6. Insert the USB stick into the USB port on the front panel of the unit.
7. Press the power button *twice* in quick succession. The power button changes color to magenta when the upgrade procedure starts. If the button does not show the magenta color, then repeat the previous steps.

The power button will flash several colors and the fans will be on full throughout the upgrade process. Please wait approximately four minutes as the unit upgrades. It will automatically display the menu screen when complete.



Remote Upgrade Using SFTP

From software version 3.4.1 you can upgrade the software on your unit(s) from a remote location as follows:

1. Complete and submit the access request form.
2. Click the link to download the .ZIP file for the desired software release, see above.
3. Extract the file **phab_qx_upgrade.bin** to a suitable location on your workstation.
4. Log on remotely to a unit to be upgraded using SFTP, enter:
sftp qxuser@<Qx_IP_Address>
For more information, see the section ["Using Secure FTP \(SFTP\)" on page 3-24](#).
5. Enter the password for the qxuser: **phabrixqx**
You should see the message **Connected to qxuser@<Qx_IP_Address>**
6. Use the SFTP **put** command to upload the upgrade file to the upgrade directory of the unit:
/transfer/upgrade.
You should see the percentage completion and time remaining for the transfer displayed at the right of the terminal window.



```
sftp> put phab_qx_upgrade.bin /transfer/upgrade
Uploading phab_qx_upgrade.bin to /transfer/upgrade/phab_qx_upgrade.bin
phab_qx_upgrade.bin                               57% 109MB 12.7MB/s 00:06 ETA
```

Figure 3-22: Uploading the Upgrade File Remotely to the Unit

7. On completion of the upload the unit automatically detects the presence of the upgrade file and starts its upgrade cycle.

Note: The remote upgrade function requires software version 3.3.1 or higher to be installed on the target unit. When this software version is available you can choose to install any available version of the software. If, however, you install a version below 3.3.1, the remote upgrade facility will no longer be available on that unit.

Upgrading the Software Options

You can order and install optional software toolkits at any time after purchasing your unit. You will receive an email from PHABRIX with an encrypted file attachment:

Encrypted_file.enc.

Install the software for a toolset option as follows:

1. Make sure that the unit is powered on.
2. Download the email attachment and copy to a blank, FAT32 formatted USB memory stick.
3. Insert the USB memory stick into any of the USB ports on the front or rear of the unit.
The unit detects the software package and displays a dialog box listing the licenses currently installed alongside the new licenses available with the option upgrade.

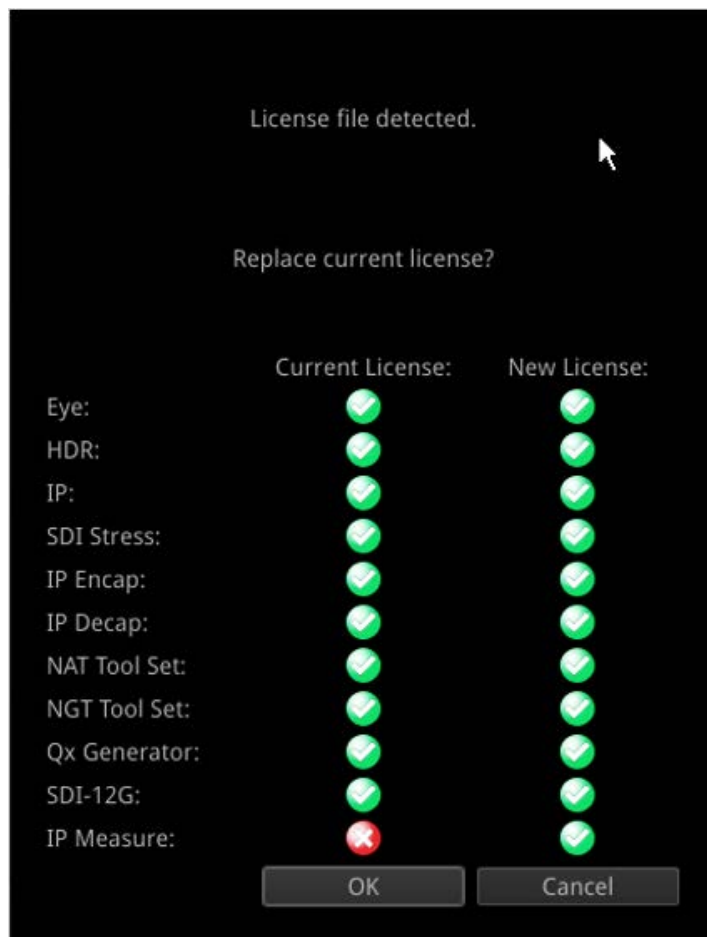

Figure 3-23: Confirmation Dialog for Software Option Upgrade

4. Make sure that the new option(s) you have purchased are listed in the **New License** column with a green check mark then click OK to update the license.
After updating the option licenses, the unit opens a further dialog box requesting you to restart to apply your changes and activate the new option(s).

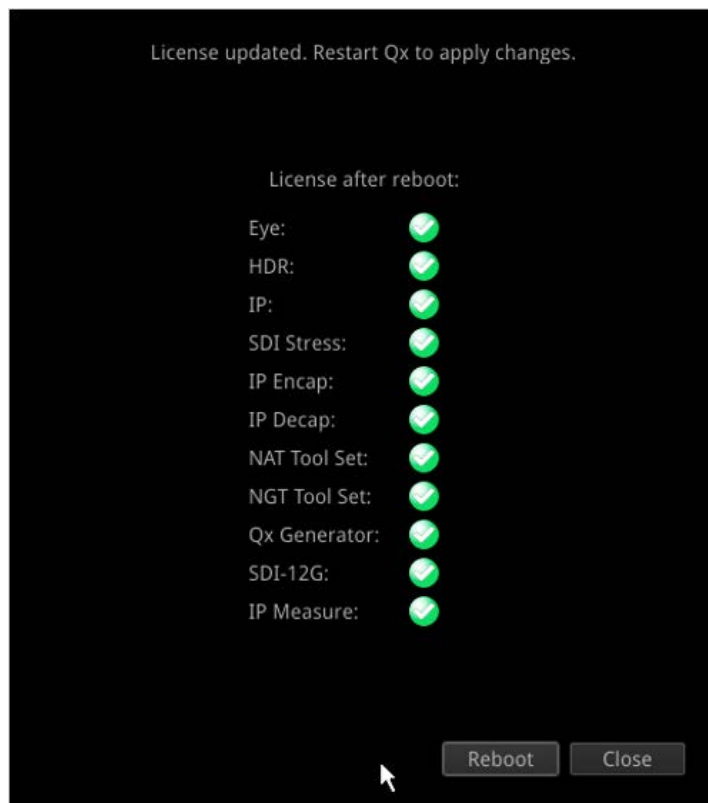

Figure 3-24: Requesting a Reboot to Activate the New Option(s)

5. Confirm that all expected licenses have been updated, then click **Reboot**.
The unit reboots and the upgraded options will be available for use (depending on the Boot mode.)
6. Open the **About...** dialog from the PHABRIX Launch menu and confirm that the new toolkit license(s) are available.

Managing Files with the USB File Manager

Overview

To transfer and manage your files, the unit provides a USB File Manager which enables you to download files from the unit to a FAT32 formatted USB memory stick or to upload files from USB to the unit. To display the USB File Manager, simply insert a USB memory stick into one of the USB connectors on the front or rear panels of the unit. When displayed, the USB File Manager window is divided into two panes – the left-hand pane displays files available on the unit and the right-hand pane displays files and folders on the USB stick. You can either select files and then choose a copy option from the right-click menu or drag selected files and drop them into the desired target window. With the USB File Manager you can:

- Select files on either device
- Copy selected files in two directions (from unit to USB or USB to unit)
- Drag and drop selected files between the unit and USB device(s)
- Rename files on the USB stick.
- Create folders on the USB stick
- Delete files from the unit or USB stick.

You can upload or download the following file types to or from the unit:

- Test patterns
- Screenshots
- Presets
- Logfiles
- TIFF image files.

The USB Device drop-down menu in the top-right of the window allows you to select either of up to three USB devices that may be connected to the USB ports. Available space on both the unit and USB stick is displayed at the bottom of the File Manager window.

Note: The USB File Manager is disabled on a remote Qx Client.

Opening the USB File Manager

To open the USB File Manager:

- Insert a USB memory stick into one of the USB ports on the front or rear panel of the unit.

This automatically opens the following file manager dialog:

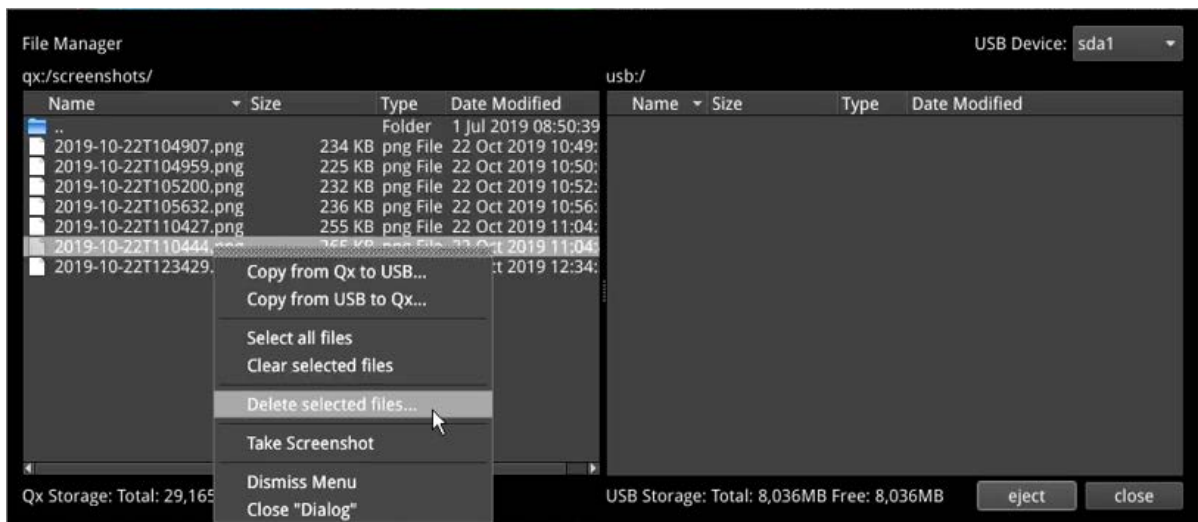

Figure 3-25: USB File Manager Window

Alternatively, you can launch the File Manager from the Instrument Launch Menu as follows:

- Click PHABRIX, then select File Manager from the menu.

If you unintentionally close the File Manager by clicking on another window or instrument, you can re-open it from the Instrument Launch Menu as described above.

Copying Files from the Unit to USB

Copy files from the unit as follows:

1. Insert a USB stick into one of the USB ports and wait for the USB File Manager window to open.
2. Select the files to download in the left-hand pane, or choose **Select All** from the right-click menu.

To de-select a file, simply click it again. You can also choose **Clear Selected Files** from the right-click menu to de-select multiple files. To open a folder, double-click the folder icon.



Figure 3-26: Copying Selected Files from the Unit to a Connected USB Stick

3. Right-click anywhere in the File Manager window and select **Copy from Qx to USB...** from the menu. This opens the Copy Source Files dialog.
4. Check that the selected files and destination are correct then click **Copy** to confirm.

Uploading Files from USB to the Unit

Upload files to the unit as follows:

1. Insert a USB stick into one of the USB ports and wait for the USB File Manager window to open.
2. Select the files you want to upload in the right-hand pane, or choose **Select All** from the right-click menu.
3. Select the target folder on the unit in the left-hand pane for the uploaded files.
4. Right-click anywhere in the File Manager window and select **Copy from USB to Qx...** from the menu. This opens the Copy Source Files dialog.
5. Check that the selected files and destination folder are correct then click **Copy** to confirm.

Deleting Files from the Unit

Delete files on the unit as follows:

1. Launch the USB File Manager from the Instrument Launch Menu.
2. Select the files you want to remove in the left-hand pane, or choose **Select All** from the right-click menu.
3. Right-click anywhere in the File Manager window and select **Delete selected files...** from the menu. This opens the Delete Files dialog.
4. Check that you have selected the correct files then click **Delete** to confirm.

Event Logging on the Unit



Overview

Event logging on the unit enables you to view the logs in the **Event Logging** Instrument window. The unit allocates 500 lines for logging detail before overwriting log data. It will also recall the log data last captured if the unit is started from cold. The setting for logging data will need to be re-entered from a cold start using the right-click submenu. You can also access and save Logs using the REST API.



Figure 3-27: Event Logging and Menu Options

SDI Modes

In SDI mode, right-click the mouse in the instrument window to display the following options:

- Record Jitter Timing Logs > [Enabled, Disabled]
- Record Jitter Alignment Logs > [Enabled, Disabled]
- Record SDI Input Standard Logs > [Enabled, Disabled]
- Record SDI Input Rate Logs > [Enabled, Disabled]
- Record SCTE104 Logs > [Enabled, Disabled]
- Record REST API Request Logs > [Enabled, Disabled]
- Record Reference Locking Logs > [Enabled, Disabled]
- Record SFP Logs > [Enabled, Disabled]
- Record Audio Input Presence Logs > [Enabled, Disabled]
- Clear logs

IP Modes

In IP mode, right-click the mouse in the instrument window to display the following options:

- Record IP Tx Logs > [Enabled, Disabled]
- Record IP Rx Logs > [Enabled, Disabled]
- Record IP Interfaces Logs > [Enabled, Disabled]
- Record PTP Logs > [Enabled, Disabled] (note IP 2110 only)

- Record SCTE104 Logs > [Enabled, Disabled]
- Record REST API Request Logs > [Enabled, Disabled]
- Record Reference Locking Logs > [Enabled, Disabled]
- Record SFP Logs > [Enabled, Disabled]
- Record Audio Input Presence Logs > [Enabled, Disabled]
- Clear logs

Remote Connection to the Unit

Overview

Various methods are provided to enable you to establish a remote connection with a Qx system, depending on your requirements, for example you could establish a remote connection using one of the following methods:

- VNC
- REST API
- SFTP
- Web browser.

For further information on the REST API, see the section ["Using the REST API for Remote Access" on page 16-2](#)

Note: If you need to transfer files to or from a unit and you have direct access to the unit, it is recommended to use the USB File Manager available from the Instrument Launch Menu.

Available Functionality

Operational Control

VNC	Remotely view the screen and control the user interface.
REST API	Remotely send operational control commands and retrieve data and status information.

File Management

SFTP	Upgrade the unit remotely; available from software version 3.4.1. Retrieve Log, Preset, and Screenshot files. Delete these files. Add saved presets from a different unit. Add, retrieve, and delete user-created test pattern files.
Web Browser	View and retrieve, Log, Preset, Screenshot, and User Test Pattern files. Alternatively, use the USB File Manager function to transfer files.

Note: In the setup directions that follow, **192.168.0.70** and **qx-020094.local** are used as examples only. Be sure to use the IP Address or mDNS Hostname specific to your unit.

Using Virtual Network Computing (VNC)

The virtual network computing or VNC facility enables you to connect from a remote location and provides you with direct screen control of the unit.

When you enable VNC, the unit acts as a VNC server, giving you remote access from a VNC viewer client application on your local computer.

For more information on establishing a remote VNC connection to the unit, see the section: ["Qx Network and Automation" on page 3-2.](#)

Using Secure FTP (SFTP)

You can use Secure FTP (SFTP) to perform the following tasks on the unit:

- Upgrade the software from a remote location
- Retrieve event logs, presets, screenshots and user-defined test pattern files
- Delete event logs, presets, screenshots and user-defined test pattern files
- Upload saved presets from another unit and user-defined test patterns.

Connecting to the Unit Using SFTP

Run your chosen SFTP client application on the computer from which you will connect to the unit (your SFTP server).

Enter the unit's host address using the specific IP Address of your unit or its mDNS Hostname (if mDNS is enabled on your computer), in one of the following formats:

- **sftp://192.168.0.70**
- **sftp://qx-020094.local**

In addition, enter the following details:

- Username: **qxuser**
- Password: **phabrixqx**
- Port: **22**

Once connected, open the transfer directory to access the following folders on the unit:

- **common licenses**
- **log** - for the Event Log
- **presets**
- **screenshots**
- **sfp**
- **testPatterns**
- **upgrade**
- **userTestPatterns**

You can download or delete files from any of these folders. In addition, you can add or upload files to the presets, upgrade and userTestPatterns folders.

Using a Web Browser

A web browser can be used to view Event Log, Screenshot, Preset, and User Test Patterns files, and retrieve them.

Connecting to the Unit Using a Web Browser

In the web browser of your choice on your computer, enter the IP address of your unit, in the following format:

- **http://192.168.0.70**

Once connected, access the logs, presets, screenshots, and userTestPatterns folders as required. View and save files to your computer as required.

Note: Files cannot be deleted using the web browser.

SDI System Setup and Configuration

This chapter describes the System Instruments used to set-up and configure the unit in SDI mode for your desired test and measurement functions and includes the following sections:

- [SDI Connections to the Unit](#)
 - [SDI Input and Output Schematic](#)
 - [SDI Input / Output Configurations \(SDI Modes\)](#)
 - [SDI Inputs Using BNC Connectors](#)
 - [SDI Outputs Using BNC Connectors](#)
 - [Overview of SDI SFP Connections](#)
 - [SDI Inputs Using SFP Connectors](#)
 - [SDI Outputs Using SFP Connectors](#)
- [System IO](#)
- [AES IO Config](#)
- [Video Timing & System Reference](#)
- [SFP \(A, B\) - Info](#)

SDI Connections to the Unit

Overview

A choice of two SDI connector types – BNC and SFP+ – is available for the transmission of SDI signals in to and out of the unit as shown below.



BNC Connector (Male) on SDI Cable



BNC Connector (Female) on Rear Panel

Figure 4-1: BNC SDI Input / Output Connectors

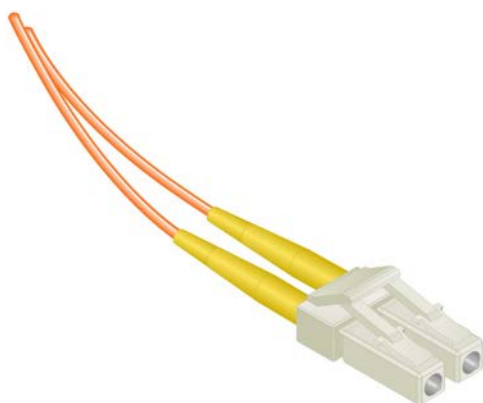

LC-LC Type Optical Fiber (Multimode) Connector



1.5 – 3 Gbit/s MSA SFP+ Optical Transceiver Module in Rear Panel

Figure 4-2: Optical Fiber Connector and 1.5G to 3 G SFP+ Optical Transceiver Module

SDI Input and Output Schematic

The following graphic shows a schematic view of the SDI and IP inputs and outputs to and from the Analyzer and Generator circuitry, using either BNC or SFP connectors.

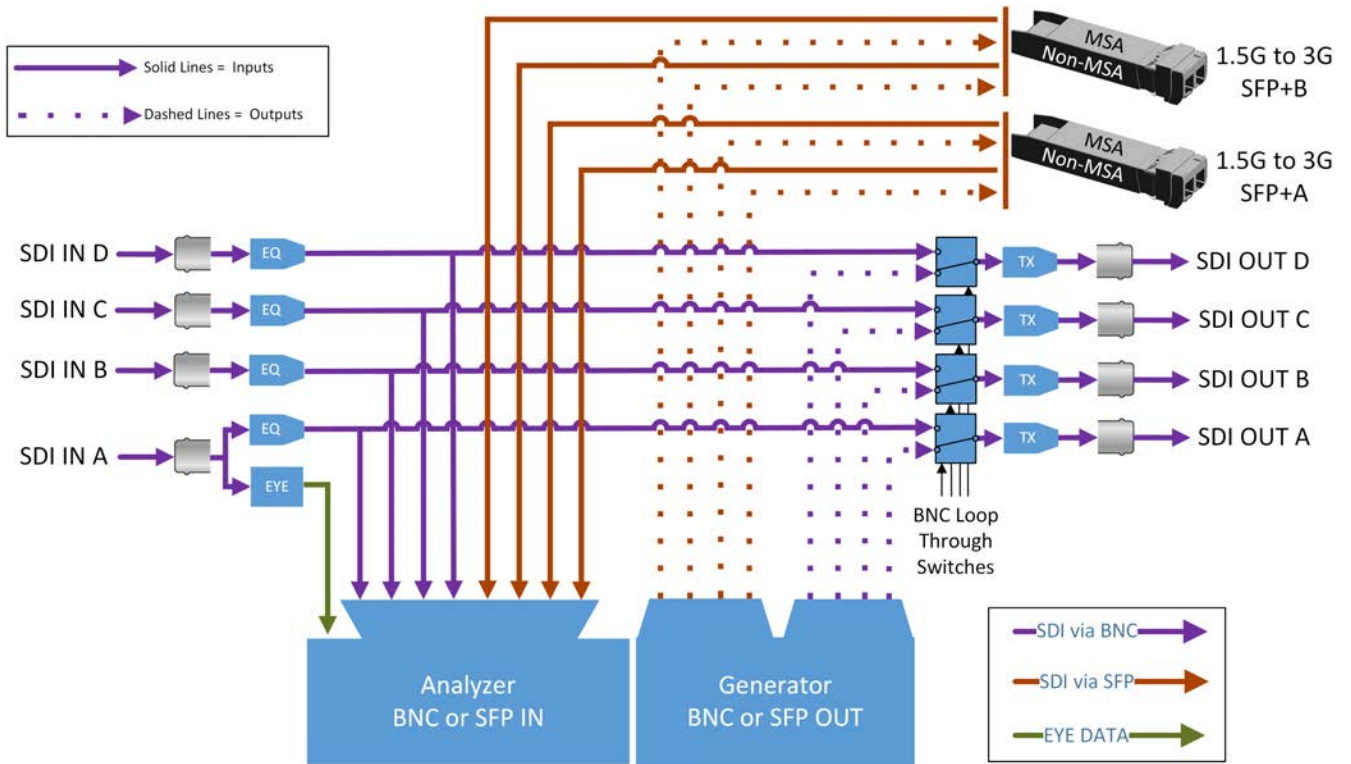

Figure 4-3: SDI Input / Output Connectors to Analyzer / Generator Circuitry

Where:

- **EQ** = SDI Cable Equalizer
- **Tx** = Signal Transmitter
- **EYE** = RTE™ Real-time Eye Processing Circuitry
- **MSA** = Multi-source Agreement standard

For SDI Inputs:

- **BNCs**: Lead with Input A
- **SFPs**: Use any input

Note: The SDI BNC Loop feature is available with SDI connector configuration: BNC In / BNC Out only.

Note: It takes marginally longer for the unit to lock-on to SDI Input signals received over SFP connectors than signals received over BNC connectors.

For SDI Outputs:

- **BNCs**: Generator Output Copy is optional in combination with SDI BNC Loop configuration
- **SFPs**: Generator Output copy functionality is always on.

SDI Input / Output Configurations (SDI Modes)

You can choose different combinations BNC and SFP+ connector types for input / output, to and from the unit, from the following:

- BNC In / BNC Out (Default)
- SFP In / SFP Out
- BNC In / SFP Out
- SFP In / BNC Out

Select the SDI connector configuration you require in the **System IO** Instrument submenu (SDI Input Source and SDI Out). For more information, see: "[System IO for SDI Modes](#) " on page 4-9.

Note:

Use only SDI SFPs approved by PHABRIX. The unit displays an error message if you insert an incompatible SFP. For more information, please contact PHABRIX Support at: <https://www.phabrix.com/support>

SDI Inputs Using BNC Connectors

The Physical Layer input connection for eye and jitter is the right-most BNC connector (when viewed from the rear) fitted with a black- or red-colored nut. This provides the multirate eye and jitter connection from 1.5G HD-SDI to 12G-SDI. There are four 12G-SDI capable input BNCs for the analyzer: SDI In A, B, C, and D.

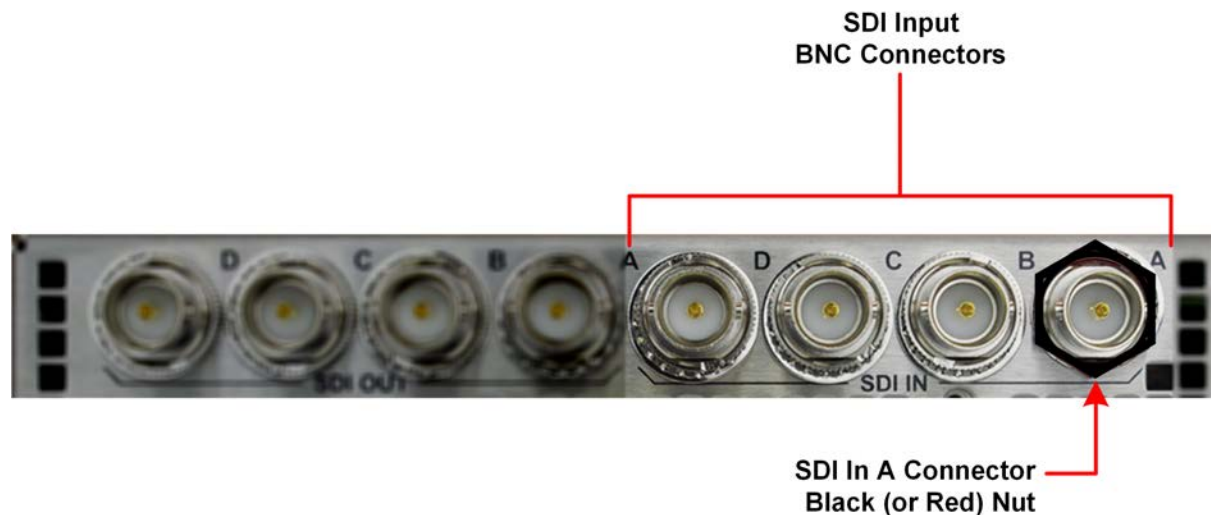

Figure 4-4: Rear Panel SDI Input BNC Connectors

Up to four SDI inputs may be connected at any one time, however, the system will automatically determine the signal set to analyze - be it single link, dual link, or quad link - based on the SMPTE ST 352 packets present. The algorithm looks to **SDI In A** first and then determines the overall standard.

If the SMPTE ST 352 packets are known to be incorrect then you have the option to select **Ignore payload identifier packets (ST 352)** in the **Analyzer - Video Standard** window.

SDI BNC In-to-SDI BNC Out signal passthrough is provided by the Loop feature in the **System IO** submenu making the input SDI signal(s) available on the SDI BNC output connection.

SDI Outputs Using BNC Connectors

The flexibility of the unit enables you to control the signal on each of the four SDI BNC output connectors independently, from either the **System IO** Instrument or the **Generate - Video** Instrument.

The Generator can provide up to four SDI output signals which must form part of the same video signal set. When you enable the **Generator Copy** mode in the **Generate - Video** menu it will provide either:

- Four Single links
- Two Dual links
- One Quad link.

SDI Out A is always present and carries the first signal in the group, SDI Out B is active for dual link standards, and SDI Out C and SDI Out D are active for quad link standards.

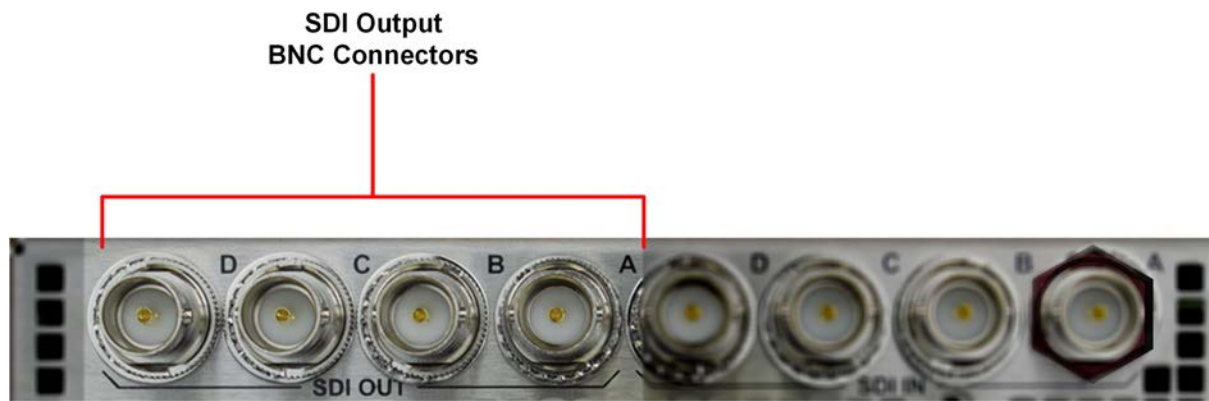

Figure 4-5: Rear Panel SDI Input BNC Connectors

For each of the four output BNC connectors, you can select from the following optional modes:

- **Off:** Mutes the selected SDI Out connector.
- **Generator:** When the **Generator Copy** function is enabled, allows you to copy the Generator output to any unused SDI Out BNCs (A, B, C or D). The number of copies depends on the number of signals from the Generator. For example, with a single link you can have up to three copies, with a dual link, one copy and with a quad link, no copies as all connectors are used by the primary Generator signal.
- **Loop SDI in A / B / C / D:** Enables you to repeat the signal presented to the SDI BNC inputs as an output from the SDI BNC Outputs. When selected, there is a direct mapping between the SDI In BNC and its corresponding SDI Out BNC, for example, SDI In A loops to SDI Out A, SDI In B loops to SDI Out B, and so on.

If the **Generator Copy** mode is disabled, the unit generates a single instance of a link standard as follows:

- One Single link
- One Dual link
- One Quad link

Note: The Loop feature is available when both the SDI Input Source and SDI Out are set to BNC only. (System IO SDI connector configuration: BNC in / BNC out.)

Overview of SDI SFP Connections

The unit has two available SFP+ cages that can be used for SDI SFPs labeled **SFP+A** and **SFP+B**. Each cage can house an SFP+ that itself has one or two signal lanes. The signal lane can be either an **Rx** (receiver/input) or **Tx** (transmitter/output).





With two SDI SFPs inserted, between two to four SDI input/outputs (IOs) are available. The number of IOs that are inputs or outputs depends on the inserted SFP types. The unit can take the following SFP types in both SFP+A and SFP+B slots:

- RxRx (Dual Receiver – Two Inputs)
- TxTx (Dual Transmitter – Two Outputs)
- RxTx (Transceiver – One Input, One Output)
- Rx (Single Receiver – One Input)
- Tx (Single Transmitter – One Output)

An RxRx RxRx combination would provide four inputs; TxTx TxTx provides four outputs; Tx RxTx provides two outputs and one input, and so on.

The unit maps the SDI signal lane positions (A, B, C, or D) of the installed SFP to internal SDI paths as outlined in the following table. Whether a lane is an input or output depends on the type of SFP installed:

Table 4-1: Overview of SDI SFP Connections

SFP+ Slot	SDI Lane Position	Mapping	System IO Rear View
SFP+A	Left	SDI IO A (Input or Output depends on SFP type. E.g., For an RxTx SFP in slot SFP+A, this would be SDI In A.)	
SFP+A	Right	SDI IO B	
SFP+B	Left	SDI IO C	
SFP+B	Right	SDI IO D	

Note: Use only SDI SFPs approved by PHABRIX. The unit displays an error message if you insert an incompatible SFP. For more information, please contact PHABRIX Support at: www.phabrix.com/support

SDI Inputs Using SFP Connectors

You can use both SFP+A and SFP+B connectors as receive (**Rx**) connections for SDI. Depending on the type of SDI SFP+ used, up to four SDI Input connections from 1.5G HD-SDI to 12G-SDI are available. The analyzer provides up to four 12G-SDI capable inputs: SDI In A, B, C, and D.

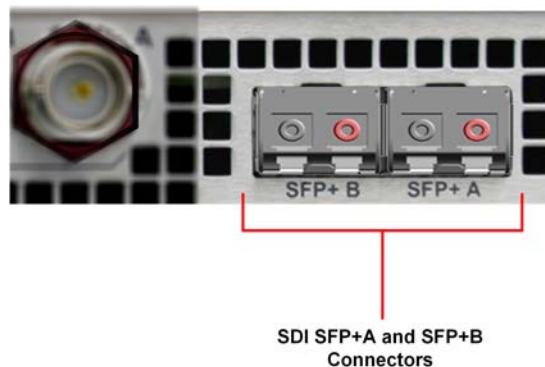

Figure 4-6: Rear Panel SDI Input SFP Connectors

Up to four SDI inputs may be connected at any one time, however, the system will automatically determine the signal-set to analyze - either single link, dual link, or quad link - based on the SMPTE ST 352 packets present. The algorithm looks to the first available SDI In (in alphabetical order) and then determines the overall standard.

If the SMPTE ST 352 packets are known to be incorrect then you can select the option **Ignore payload identifier packets (ST 352)** in the **Analyzer - Video Standard** window.

Note: The use of SDI SFPs for Eye and Jitter analysis and the Loop signal passthrough feature is not supported.

SDI Outputs Using SFP Connectors

Both SFP+A and SFP+B can be used as transmit (**Tx**) connections for SDI. Dependent on the SDI SFP types used, up to 4 x SDI output connections from 1.5G HD-SDI to 12G-SDI are available.

By default, internally, within the unit, the generator provides four SDI output signals which must form part of the same video signal set. Even when you generate a single link standard, Generator Output Copy behavior is automatically implemented for SDI SFPs. The generator will provide either:

- Four single links
- Two dual links
- One quad link.

On the internal SDI output signal paths of the unit:

- A single link standard will always be carried on SDI Out A, and then repeated on SDI Out B, SDI Out C, and SDI Out D.
- A dual link standard on SDI Out A and SDI Out B, and then repeated on SDI Out C and SDI Out D.
- A quad link standard will be delivered using all four outputs: SDI Out A, SDI Out B, SDI Out C, and SDI Out D.

Which of these internal SDI output signal paths are used as externally available SDI outputs depends on the SFP types installed. For more information, contact PHABRIX Support, see the website:

www.phabrix.com/support

Overview

Due to the complexity of the UHD TV standards, PHABRIX has introduced innovative ways to display status information. The **System IO** Instrument has been designed to provide a quick overview of the signal inputs and outputs connected to the unit.

The System IO window displays the status of signal inputs and outputs, external reference, cable length and attenuation, and connector details.

In SDI modes, this window enables you to select your inputs and outputs, whether using BNC or SFP+ connectors. Additionally for SDI BNC outputs, System IO offers a Generator Output Copy option (output copy is automatically applied for SDI SFPs), and the ability, by way of the Loop feature, to passthrough the SDI BNC input signal(s) - making them available on the SDI BNC output connector(s).

System IO for SDI Modes

The top half of the instrument window shows a graphical view of the rear panel, displaying from left to right: SDI BNC outputs, SDI BNC inputs, external reference, and SFP+B and SFP+A positions (and the I/Os of any installed SFPs.)

All active SDI inputs and outputs are indicated by colored connectors; their colors dictated by the Analyzer/Generator color scheme set in the Display Options, see the section ["Using the Instrument Launch Menu" on page 2-8](#) for more details. The color of the connectors corresponds to the color of their related instrument borders and instrument icons, to aid recognition. An entirely grayed-out connector indicates that a signal is not present, and the previously colored ring will be black.

If an SDI SFP is unseated or not present, this is displayed graphically with a black void - indicating a missing SFP. (IP SFPs will also be displayed if installed, but will only become active in one of the IP Boot modes.)

Instrument Menu Options

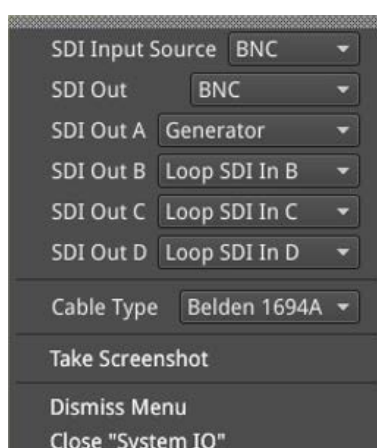

Figure 4-7: System IO Instrument - Menu Options

The SDI signal input and output mechanism can be configured in the instrument submenu - with a choice of two SDI connector types for both input and output.

Select the SDI connector configuration you require:

- SDI Input Source > [BNC (default), SFP]
- SDI Out > [BNC (default), SFP]

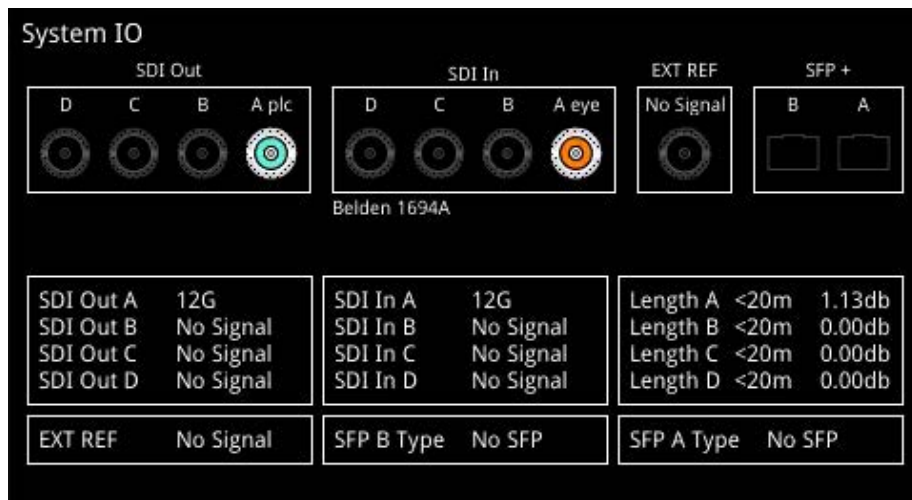

Figure 4-8: System IO Instrument Showing a 12G BNC Output and BNC input In Use

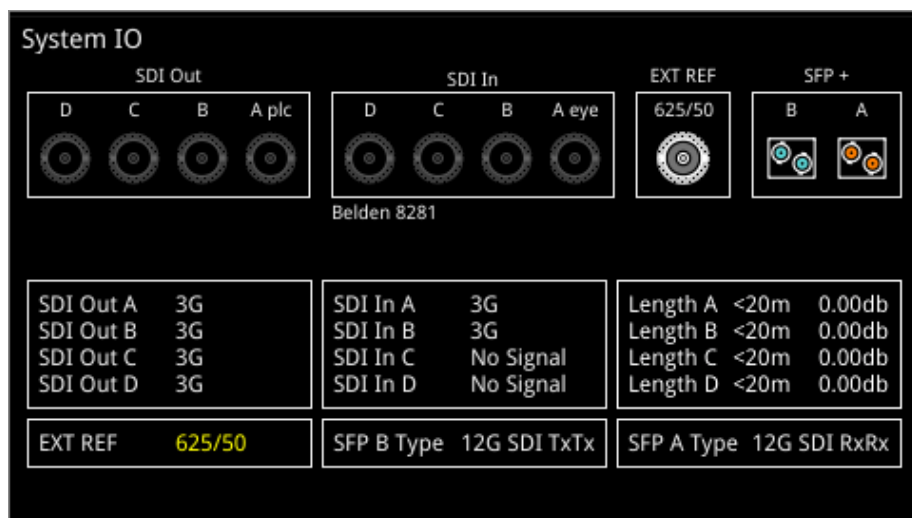

Figure 4-9: System IO Instrument Showing SFP+ Outputs and SFP+ Inputs In Use

Note:

BNC in / SFP out and SFP in / BNC out combinations are also supported. For further details on SDI SFP input and output positioning, see the section ["Overview of SDI SFP Connections " on page 4-7.](#)

Additional SDI BNC output control is provided in the instrument submenu. The menu options available depend on the selected video standard and whether you are using a single, dual or quad link.

For each SDI Out connector, you can select the following options:

- SDI Out A > [Off , Generator, Loop SDI In A]
- SDI Out B > [Off , Generator, Loop SDI In B]
- SDI Out C > [Off , Generator, Loop SDI In C]
- SDI Out D > [Off , Generator, Loop SDI In D]

Signals presented to the SDI BNC Inputs of the unit can be repeated out on the SDI BNC outputs of the unit, by enabling Loop SDI In A / B / C / D for the appropriate connector(s).

When this Loop feature is activated, there is a one-to-one mapping between the A, B, C, and D, inputs and outputs respectively. The Loop feature disables the generator activity on the SDI BNC outputs, and overrides Output Copy.

Note: To use the Loop SDI feature, you must have a valid input connected to the SDI In A BNC.

The Loop feature is available in a BNC in / BNC out configuration only.

To duplicate output of the generated single link or dual link video standard on all unused SDI Out BNCs, enable the option **Generator Copy** available in the **Generator - Video** submenu.

Note: Copying of the Generator output is not applicable to quad link standards as all outputs are used.

Note: Output copy functionality is automatically applied when using SDI SFP outputs.

The presence of an external reference and its standard, is also displayed graphically with a colored connector. If you set the system to lock to an external reference and achieve a stable lock, then the inner ring of the EXT REF BNC ([Figure 4-9](#)) is highlighted in gray. The following EXT REF BNC colors relate to various external reference status:

- Gray (reference connected)
- Red (error with reference)
- Black (no reference connected)

Note: The EXT REF BNC shows the status of external reference only; which is not necessarily the system reference. Overall system reference is selected in the **Timing and System Reference** instrument window.

Below the graphical connector display, tables display input and output status, cable length and attenuation, external reference standard and status, and SFP type and presence information. You can hover the mouse over the external reference and SFP status information to display tooltips containing additional status information.

The external reference table displays the following states:

- EXT REF: [No Signal, Unstable, 525/59.94, 625/50, etc...]

If an external reference is not currently being used as system reference, its field text will display in yellow. When an external reference is the system reference, this table field text is colored white.

Measurements for cable length (in meters) and attenuation (in decibels) are displayed for each SDI BNC input. To measure the length of a connected cable, be sure first to select the correct cable type from the instrument submenu:

- Cable Type > [Belden 8281, Belden 1505, Belden 1694A, Belden 1855A, Image 1000]

The selected cable type is shown below the SDI In BNC connector view.

AES IO Config (SDI Mode)



Overview

The unit provides powerful and flexible functionality for handling AES (Audio Engineering Society) input and output audio signals when present on pins 1 - 4 of the rear panel 26-way D-type connector. See the section ["Technical Specifications" on page 1](#) for more information on the connector pinouts. You can use a D-type to BNC converter to access the AES I/Os.

The **AES IO Config** Instrument provides an interface to configure the AES I/Os as follows:

- Up to four AES signals (a combination of inputs and/or outputs) can be handled at the same time
- SDI Input to AES Output audio conversion is available for both PCM and Dolby encoded audio (using the **Transmit - Analyzer**)
- Route AES Input signals to other AES outputs to provide a single loop output or up to three copy outputs (using **Transmit - Passthrough**).

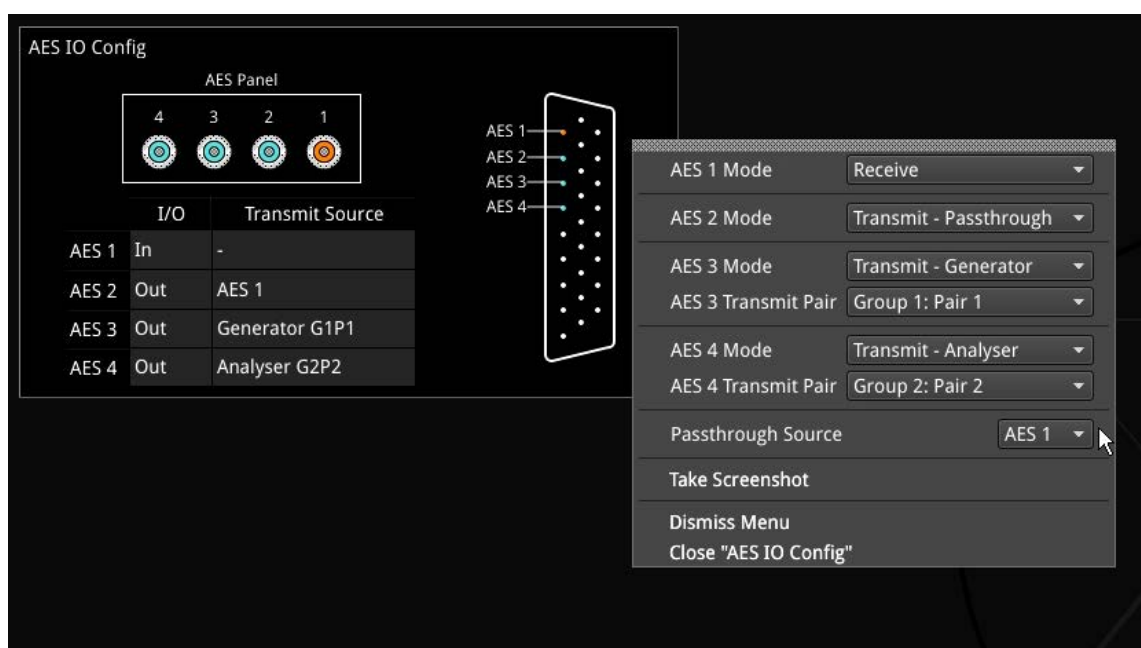

Figure 4-10: AES IO Config Instrument and Options Menu

The window provides a graphical display of the 26-way D-type rear panel connector, and labels the AES pins (pins 1 - 4). The AES Panel graphic shows the AES I/O BNCs in any AES breakout board connected to the rear panel D-type connector.

In both graphics, an active AES I/O is displayed in the Analyzer color when configured as an AES Input (in Receive mode) or in the Generator color when configured as an AES Output (in Transmit mode).

Below the AES Panel graphic, a table lists the status of each AES I/O. For AES Outputs the table also shows the transmit mode source. Any issues in the audio transmit source are highlighted in the table text as follows:

- Red: Configuration error
- Yellow: Audio source not present.

Hover the mouse over the error text to display a tooltip describing how to resolve the issue.

Instrument Menu Options

Configure the AES I/Os in the instrument submenu as follows:

Each AES I/O can be set as an input (receive), or output (transmit):

- Off: AES I/O is switched off
- Receive: I/O is set to AES Input
- Transmit - Generator: I/O is set to AES Output

The output audio signal source is the audio generator (See the Audio tab of the **Generator – Configuration** instrument.)

- Transmit - Analyzer: I/O is set to AES Output

The output audio signal comes from Image/Sub-image 1 of the Analyzer input (SDI or IP 2022-6)

- Transmit - Passthrough: I/O is set to AES Output

The output audio signal is routed from the chosen AES input Passthrough Source

- AES 1/2/3/4 Mode > [Off, Receive, Transmit - Analyzer, Transmit - Generator, Transmit - Passthrough]
- AES 1/2/3/4 Mode > Transmit - Analyzer/Generator > AES 1/2/3/4 Transmit Pair > [Group 1: Pair 1, Group 1: Pair 2, Group 2: Pair 1, Group 2: Pair 2, Group 3: Pair 1, Group 3: Pair 2, Group 4: Pair 1, Group 4: Pair 2, Group 5: Pair 1, Group 5: Pair 2, Group 6: Pair 1, Group 6: Pair 2, Group 7: Pair 1, Group 7: Pair 2, Group 8: Pair 1, Group 8: Pair 2]
- Passthrough Source > [AES 1, AES 2, AES 3, AES 4]



Overview

The **Video Timing & System Reference** Instrument provides measurements that enable you to assess the timing quality of the input relative to a selected reference. If necessary, you can then set timing offsets against which to measure. This section covers the measurement and adjustment tools available for SDI modes.

Video Timing in SDI Mode

SDI A vs System Reference

In SDI Mode, the upper section of the **Video Timing & System Reference** instrument window compares the timing of the SDI-A input against a selected System Reference to which the unit is locked. You can select the System Reference from External, SDI or Free Run reference signals. The upper section of the Instrument displays the following resulting measurements in both spatial units (lines and pixels) and time (μs or ns):

- Measured Timing
- Offset to Apply (with External Reference and SDI only)
- Offset Timing (with External Reference and SDI only.)

You can choose to apply an Offset to the System Reference against which to measure. The position of the Offset (Offset Position) is shown on the timing meter as a black triangle.

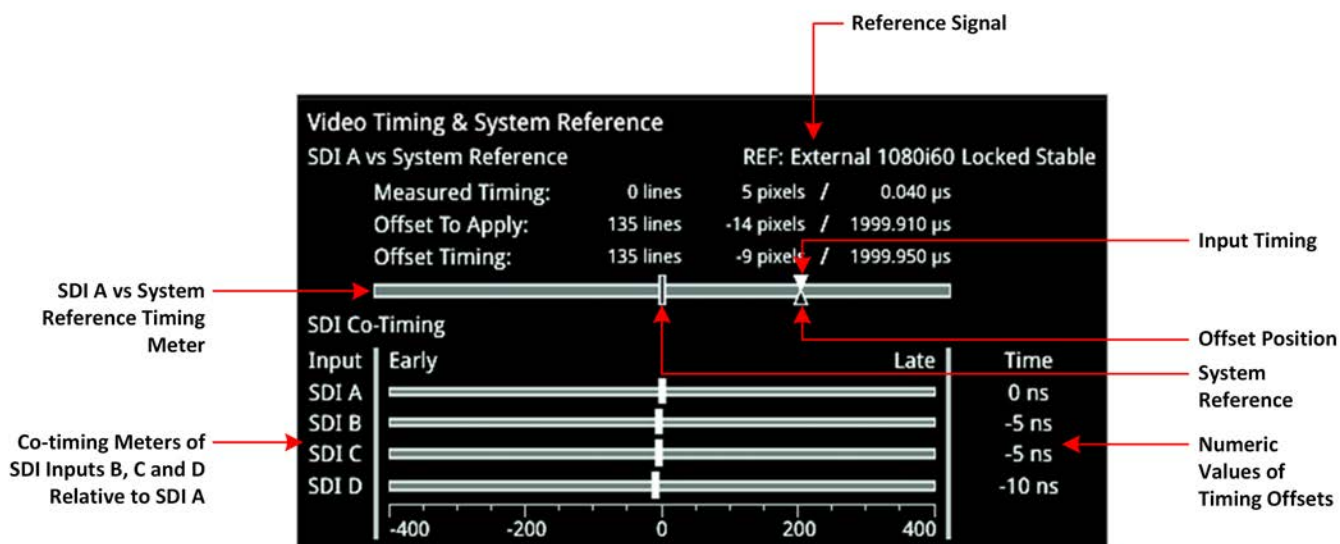

Figure 4-11: Video Timing & System Reference Instrument (SDI Mode)

SDI Co-Timing

The lower SDI Co-Timing section of the window displays timing information for each input of a single (SDI-A), dual (SDI-A and -B) or quad link (SDI-A, -B, -C and -D) signal. Many of the standards associated with UHDTV are a combination of signals to form the image plane. Relative timing tools indicate that the dual or quad elements creating the single picture are correctly aligned and compared with the reference. The instrument presents both graphic and numeric values for this critical measurement.

The horizontal Early/Late timing meters show whether the timing offset on each subsequent input is earlier or later than the input signal on SDI-A. The Instrument displays the actual timing offset values in the Time column to the right of the timing meters. Early timings are show as negative values and late timings are positive. Any red text indicates a measurement outside the specification.

Note: The Timing instrument in this software release is locked to SDI Input A (SDI In A).

Instrument Menu Options

The following table lists the options available in the Video Timing & System Reference instrument submenu:

Table 4-2 : Video Timing & System Reference Menu Options (SDI Mode)

Item	Options	Description
System Reference	Free Run External Reference SDI	System reference locking controls define the reference to which the unit and any signal it generates is locked. By selecting the default option Free Run, the system locks to the internal oscillator as the timing reference signal. If the system loses the external or SDI reference signal for some reason, the system will automatically switch to use the Free Run reference signal. System reference lock status information is displayed in the upper-right corner of the instrument, and any error in the health state of the reference is displayed in red.
Reference Timing Meter Range	+/- 0.1 line, +/- 0.5 line, +/- 0.5 frame	Adjusts the displayed range of the reference timing meter in the upper section of the Instrument to display readings at frame scale, or to zoom in to a fraction of a line.
Input Measurement Offset Type	Lines And Pixels Time	Defines whether to apply an offset using spatial (lines/pixels) or temporal (μ s, ns) values.
Input Measurement Time Offset	0.00, +/- 0.01, etc...	For Time as the offset type, set the timing offset in microseconds (μ s).
Input Measurement Line Offset	0 to +/- (Total number of Lines in the current standard minus one.)	For Lines And Pixels as the offset type, set the coarse timing offset as a number of lines.
Input Measurement Pixel Offset	0 to +/- (Total number of Pixels per Line in the current standard minus one.)	For Lines And Pixels as the offset type, set the fine timing offset as a number of pixels.
Set Input Measurement Offset to current	N/A	Sets the input measurement offset to the same position as the current SDI In A signal.
Clear Input Measurement Offset	N/A	Removes any input measurement offset.

SFP (A, B) - Info (SDI Modes)



Overview

The **SFP - Info** windows provide at-a-glance physical status information on each SFP+ module, including Identifier, Connector, line code (Encoding), Vendor details and approval status for use with the unit. More detailed status information for the SFP, such as temperature and voltage are also displayed.

SFP A - Info		Temperature: 42.9 °C Voltage: 3.21 V Rx Power: 0.52 mW Tx Power: 0.46 mW	
Status	Approved	Link Length OM4 / Copper (10m / m)	0
Vendor	Gigalight	Bit Rate (MBd)	10300
Part No	GPP-85192-SRC	Optical Wavelength (nm)	850
Vendor OUI	24-00-00	Temp High Warning (°C):	80.0
Revision	1.0	Temp Low Warning (°C):	-5.0
Serial No	M1802235564	Temp High Alarm (°C):	85.0
Identifier	SFP or SFP+	Temp Low Alarm (°C):	-10.0
Ext Identifier	GBIC/SFP function via two-wire only	Voltage High Warning(V)	3.60
Connector Type	LC	Voltage Low Warning (V)	3.00
Encoding	64B/66B	Voltage High Alarm (V)	3.70
10G Ethernet	10G Base-SR	Voltage Low Alarm (V)	2.90
Fibre Channel Link Length	Short Distance (S)	Tx Power High Warning (mW):	1.26
Fibre Channel Technology	Shortwave laser w/o OFC (SN)	Tx Power Low Warning (mW):	0.13
Fibre Channel Transmission Media	Multimode 62.5µm (M6), Multimode 50µm (M5/M5E)	Tx Power High Alarm (mW):	1.58
Rate Identifier	Unspecified	Tx Power Low Alarm (mW):	0.10
Link Length Smf (km)	0	Rx Power High Warning (mW):	0.79
Link Length Smf (m)	0	Rx Power Low Warning (mW):	0.05
Link Length OM1 (m)	300	Rx Power High Alarm (mW):	1.00
Link Length OM2 (m)	300	Rx Power Low Alarm (mW):	0.04
Link Length OM3 (m)	0		

Figure 4-12: SFP (A, B) - Info Instrument

Instrument Menu Options

Temperature and Power display units can be adjusted through the right-click submenu:

- Temperature Units > [°C, °F]
- Optical Power Units > [mW, dBm]

IP System Setup and Configuration

This chapter describes the System Instruments used to setup and configure the unit for your desired test and measurement functions and includes the following sections:

- [Overview](#)
- [IP Input and Output Schematics](#)
- [IP Connections](#)
 - [ST 2110 Input Optical SFP Connection \(Analyzer - IP 2110 Mode\)](#)
 - [ST 2022-6 Input Optical SFP Connection \(Analyzer - IP 2022-6 Mode\)](#)
 - [ST 2022-6 Output Optical SFP Connection \(Generator - IP 2022-6 Mode\)](#)
- [System IO for IP Modes](#)
- [SFP IP Network](#)
- [LLDP Information \(IP ST 2110 Mode\)](#)
- [SFP \(A, B\) - Info \(IP Modes\)](#)
- [IP Receive - NMOS \(IP 2110 Mode\)](#)
- [SFP A/B - PTP Info \(IP 2110 Mode\)](#)
- [Video Timing & System Reference \(IP Modes\)](#)
- [IP Receive - Flow Select](#)
 - [Multicast Setup \(Multicast Requests\)](#)
 - [Flow Protocol Configuration \(Flow Config\)](#)
- [Analyzer - 2110 Format Setup \(IP ST 2110 Mode\)](#)
- [Video Timing & System Reference \(IP 2110 Mode\)](#)
- [AES IO Configuration \(IP Modes\)](#)

IP Connectors and Modules

Overview

All IP connections to the unit are made using SFP+ or SFP28 (recommended) transceiver modules as shown below.

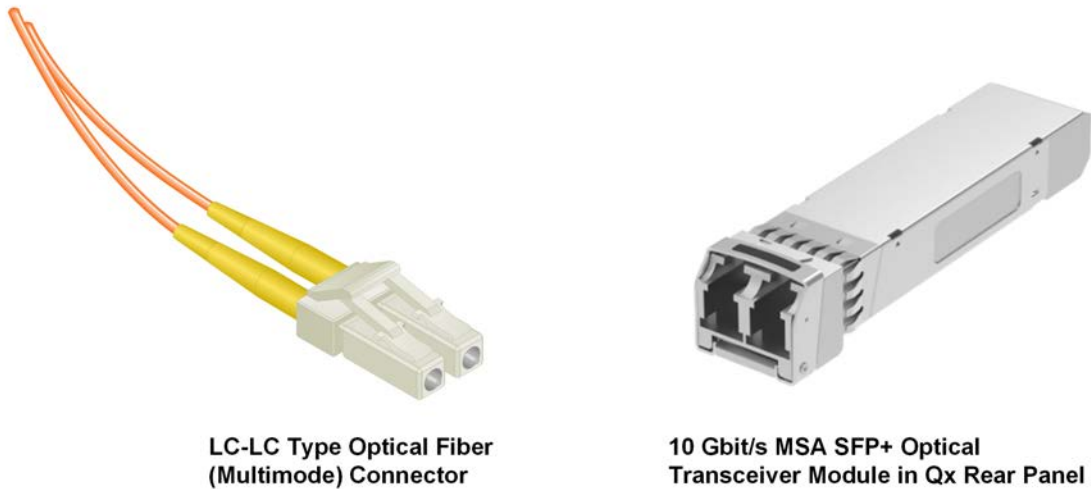

Figure 5-1: Optical Fiber Connector and 10 Gbit/s MSA SFP+ Optical Transceiver Module

Note:

The type of optical transceiver module supported by the unit depends on the version ID of the Mezzanine interface board as follows:

- Units with Mezzanine ID 0 to 9 support 10G Ethernet MSA SFP+ IP Optical Transceiver Modules supplied by PHABRIX.
- Units with Mezzanine ID 10 and above may use either PHABRIX supplied or third party 10Gs Ethernet MSA SFP+ IP Optical Transceiver Modules.

You can find the version of an installed Mezzanine board in the **About** dialog, see the section: ["Checking the Unit Licenses" on page 3-9](#).

IP Input and Output Schematic (ST 2022-6)

The following graphic shows a schematic view of IP inputs and outputs to and from the Analyzer and Generator circuitry, using SFP+ modules.

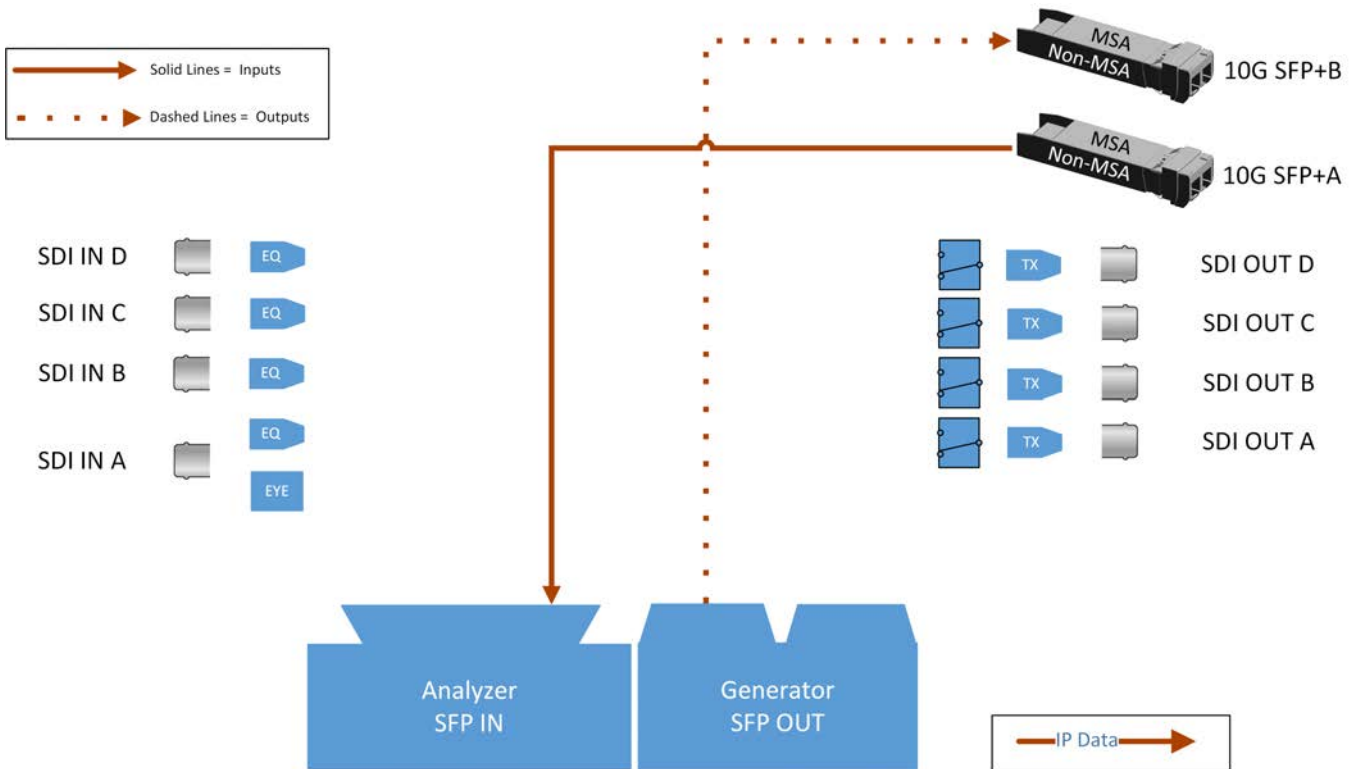

Figure 5-2: IP Input/Output Modules to Analyzer / Generator Circuitry (ST 2022-6)

Where:

- **EQ** = SDI Cable Equalizer (Not Used with IP)
- **Tx** = Signal Transmitter (Not Used with IP)
- **EYE** = Eye Processing Circuitry (SDI Only)
- **MSA** = Multi-source Agreement

IP Input and Output Schematic (ST 2110)

The following graphic shows a schematic view of IP inputs and outputs to and from the Analyzer and Generator circuitry, using SFP+ modules.

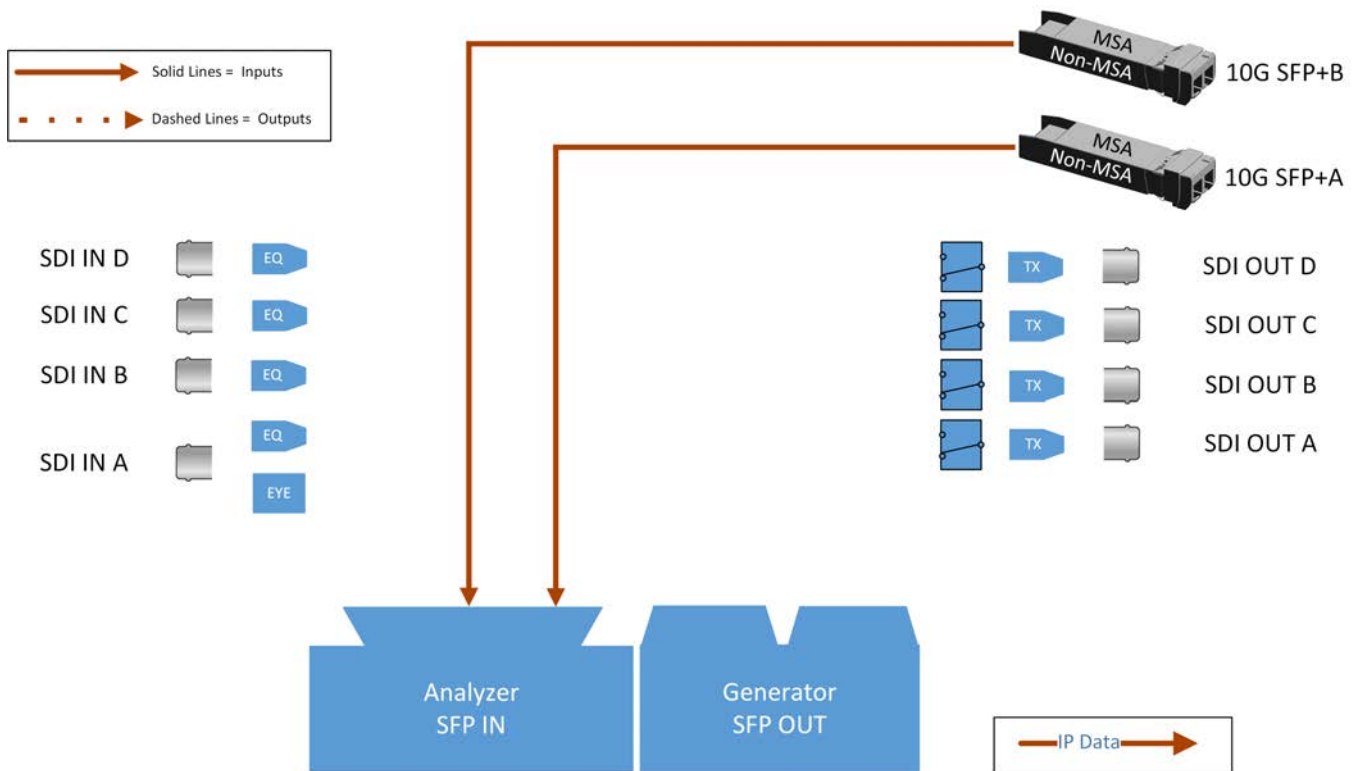

Figure 5-3: IP Input/Output Modules to Analyzer / Generator Circuitry (ST 2110)

Where:

- **EQ** = SDI Cable Equalizer (Not Used with IP)
- **Tx** = Signal Transmitter (Not Used with IP)
- **EYE** = Eye Processing Circuitry (SDI Only)
- **MSA** = Multi-source Agreement

IP Interfaces to the Unit

Overview

The standard IP option (**PHQXO-IP-STND**) supports SMPTE ST 2110 and ST 2022-6 HD/3G payloads by way of the 10G SFP+ optical transceiver modules. In addition, advanced IP network traffic measurement tools are provided by the option **PHQXO-IP-MEAS** and a packet interval profile generator for ST 2022-6 with **PHQXO-IP-NGT**.

In ST 2110 mode you can simultaneously analyze ST 2110-20 (video), 2110-30 (PCM) and 2110-31 (AES transport) audio, 2110-40 ANC media flows while using ST 2022-7 Seamless IP Protection Switching (SIPS). Furthermore, hardware-based time-stamping locked to PTP ensures accurate, real-time, deterministic timing and buffer measurements of media flows through the support of ST 2059 Precision Time Protocol (PTP) on SFP+A.

IP connections to the unit using the rear panel 10G SFP+ optical transceiver module(s) are as follows:

- ST 2110 input on SFP+A and/or SFP+B.
- ST 2110 input on SFP+A and/or SFP+B with ST 2059 Precision Time Protocol (PTP) on SFP+A only.
- ST 2110 input with ST 2022-7 SIPS on both SFP+A and SFP+B and ST 2059 Precision Time Protocol (PTP) on SFP+A.
- ST 2022-6 input on SFP+A.
- ST 2022-6 output on SFP+B.

With PHABRIX-supplied SFP+s (**PHSFP-10GE-SR / -LR**) you must use LC-to-LC optical, multimode duplex fiber cables for IP connections to the SFPs; the following cable specifications are approved by PHABRIX:

- OM1 (62.5/125)
- OM2 (50/125)
- OM3 (50/125)
- OM4 (50/125)

Note: For both SFP+A and SFP+B, use only multi-mode optical SFPs approved by PHABRIX or mono-mode SFPs of your choice. The unit displays an error message if you insert an incompatible SFP. For more information, contact PHABRIX Support, see: www.phabrix.com/support

ST 2110 Input Optical SFP Interfaces (Analyzer - IP 2110 Mode)

Since Qx software release 3.01, both SFP+A and SFP+B are available as input connections for ST 2110 IP video, audio and ancillary data (ANC) flows.

Support for ST 2059 Precision Time Protocol (PTP) is currently available on SFP+A only.

You can analyze flows on SFP+A or SFP+B, or use both interfaces in tandem in a **Seamless IP Protection Switching (SIPS)** configuration where ST 2022-7 functionality provides seamless reconstruction of flows by using the *best* packets presented on either interface.

You can define the video and audio flow parameters in the **Analyzer - 2110 Format Setup** Instrument.

In addition, the Qx software provides enhanced IP ST 2110 measurement capabilities with the optional license **PHQXO-IP-MEAS** including:

- ST 2110 **VRX_{Full}**
- ST 2110 **C_{Max}**
- Advanced video timing
- Dual-port interpacket timing windows
- ST 2059 Precision Time Protocol (PTP)
- Support for Link Layer Discovery Protocol (LLDP)
- Source Specific Multicast
- PTP timing vs External reference

ST 2022-6 Input Optical SFP Connection (Analyzer - IP 2022-6 Mode)

The receive (Rx) connection for IP ST 2022-6 video is **SFP+A**. This is the right-most SFP when viewed from the rear and provides the multirate 2022-6 IP video analyzer connection from 1.5G HD-SDI to 3G-SDI over IP.

If the SMPTE ST 352 packets are known to be incorrect then you have the option to select **Ignore payload identifier packets (ST 352)** in the **Analyzer - Video Standard** window.

ST 2022-6 Output Optical SFP Connection (Generator - IP 2022-6 Mode)

The transmit (Tx) connection for IP ST 2022-6 video is **SFP+B**. This is the left-most SFP when viewed from the rear. This output provides the multirate 2022-6 IP video packet generation from 1.5G HD-SDI to 3G-SDI over IP.

Overview

Due to the complexity of the UHDTV standards, PHABRIX has introduced innovative ways to display status information. The **System IO** Instrument has been designed to provide a quick overview of the signal inputs and outputs connected to the unit.

The System IO window displays the status of signal inputs and outputs, external reference, and connector details.

In IP modes, this window is a more passive status overview of the SFP+ and external reference connectors than is the case in SDI modes.

System IO for IP Modes

The active IP SFP+ receive inputs and transmit outputs are indicated in the dialog window by colored connectors. The color of the connectors corresponds to the color of their related instrument borders and instrument icons, to aid recognition.

An entirely grayed-out connector indicates that a signal is not present. If an SFP+ is unseated or not present, this is displayed graphically with a black void to indicate a missing SFP+.

The tables display SFP+ type and presence information, together with external reference standard and status details; as with the SDI version of this Instrument.

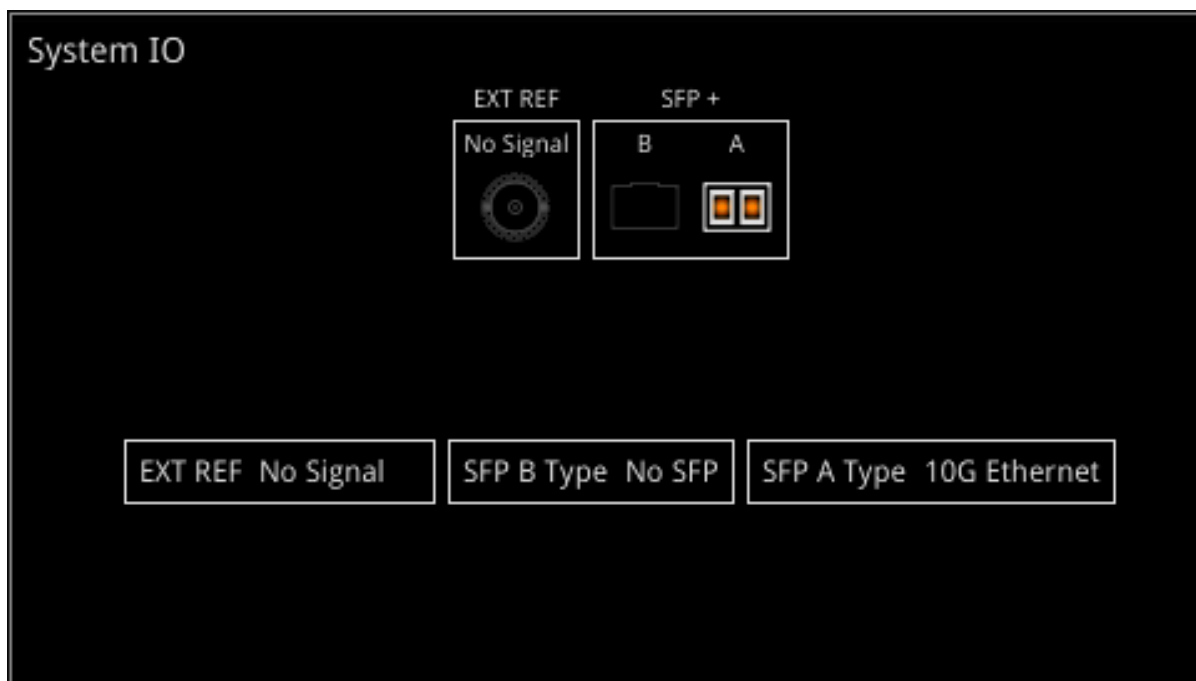

Figure 5-4: System IO Instrument Showing SFP-A in IP Mode

SFP IP Network



Requires Option(s):	PHQXO-IP-STND
---------------------	---------------

Overview

The **SFP IP Network** instrument provides an overview of the status of the unit's SFP interfaces used for ST 2022-6 IP packet transmission (**SFP+ B**) and reception (**SFP+ A**), and for ST 2110 IP packet reception (**SFP+ A and B**). This window displays the following parameters:

- **SFP+A, SFP+B** presence
- Carrier signal presence
- Interface Status
- SFP MAC and IP addresses
- Domain Name System (DNS) Server IP address
- Packet information
- IGMP maximum version status

SFP IP Network		IGMP: Max V3
	SFP A	SFP B
Carrier Signal	Present	Present
Interface	Up	Up
MAC Addr	00:1F:7F:01:4F:A0	00:1F:7F:02:4F:A0
IP Addressing Mode	Dynamic	Dynamic
IP Addr	192.168.10.19 / 24	192.168.10.111 / 24
Gateway	0.0.0.0	0.0.0.0
DNS IP Addr	192.168.10.254	192.168.10.254
Total Tx pkts	9802	2100744
Total Rx pkts	27358052964	27349796007
SFP A :		
SFP B :		

Figure 5-5: SFP IP Network Instrument

In addition, error status information is displayed at the foot of the window.

Instrument Menu Options

Right-click in the Instrument window to display a submenu you can use to set the IP address (DHCP or Static) and network/subnet mask of each SFP using a USB keyboard or on-screen keypad.

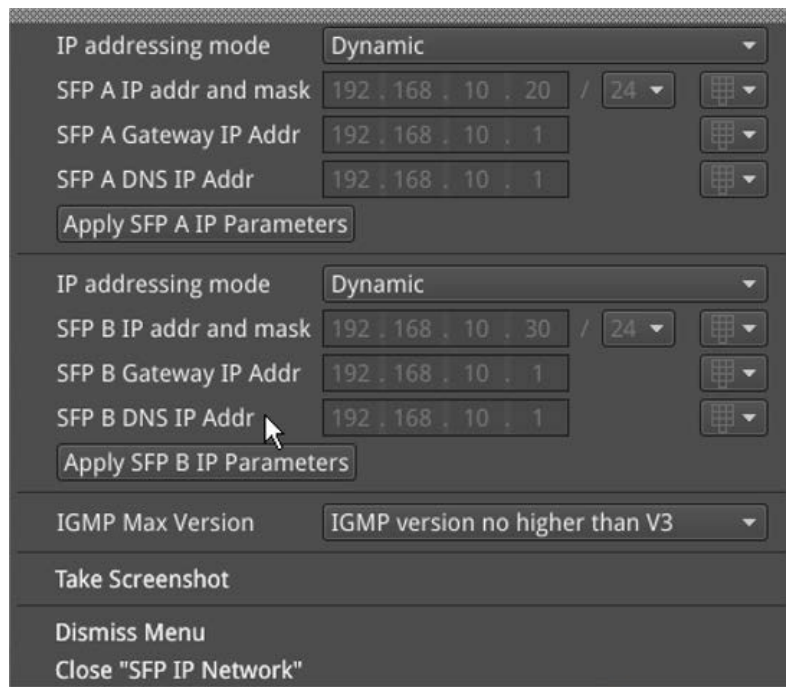

Figure 5-6: SFP IP Network Menu Options

The following table lists the options available in the SFP IP Network instrument submenu:

Table 5-1: SFP IP Network Options

Item	Options	Description
IP Addressing Mode	Dynamic (Default) Static	Select the method to set the IP address, either automatically, using DHCP, or manually, by entering the IP address directly. When set to Dynamic (default), the IP address, mask, gateway and DNS fields are grayed out and these details assigned automatically. When set to Static, the IP addressing fields are activated, allowing you to enter the IP details manually.
SFP A / B IP Addr and Mask	Automatically allocated (Dynamic) or Manual Entry (Static)	IP address and mask of the SFP. Mask selection is by way of a dropdown menu; set mask in range 8 to 31. Classless Inter-Domain Routing (CIDR) notation is used; with a default value of /24 (ie, 255.255.255.0)
SFP A / B Gateway IP Addr	Automatically allocated (Dynamic) or Manual Entry (Static)	IP address of the SFP Gateway.
SFP A / B DNS IP Addr	Automatically allocated (Dynamic) or Manual Entry (Static)	IP address of the DNS server. Set IP address of DNS Server as required, for example, when manually configuring for use with NMOS.
Apply SFP A / B IP Parameters	Instrument Control	Apply and save the IP addresses when manually allocated.
IGMP Max Version	IGMP Version no higher than: V3 V2 V1	Represents the highest supported version of the Internet Group Management Protocol (IGMP). Currently version 3 is the highest supported version. In the event that the network is running IGMP version 2 or version 1, the unit automatically switches down to the lower version of the protocol. Currently there is no visual display of the version at which the unit is running.

Item	Options	Description
		<p>You can set the maximum allowed IGMP version either using this instrument or in the PTP Info instrument. Selecting the highest available IGMP Max Version will affect all IGMP requests (including both PTP, through the PTP Info instrument, and Media Flows requested through the IP Receive - Flow Select instruments.)</p>

Requires Option(s):	PHQXO-IP-STND
---------------------	---------------

Overview

Link Layer Discovery Protocol (LLDP) is a link layer protocol used by network devices to advertise their identity, capabilities and neighbors. The **LLDP Info** Instrument is particularly useful as an in-band method when you need to identify the port and device to which the unit is connected at the other end of a wired Ethernet link on a local area network.

LLDP Info		LLDP: Active	
	SFP A Neighbour	SFP B Neighbour	Mgmt Neighbour
Sys Name	switch-16628c	switch-16628c	phobos.phabrix.local
Sys Descr	MSN2010,Onyx,SWv3....	MSN2010,Onyx,SWv3....	Ubuntu 18.04.2 LTS Linux 4.15.0-65-generi...
Chassis ID	EC:0D:9A:FC:D0:00	EC:0D:9A:FC:D0:00	2C:4D:54:D4:07:A1
Port ID	Eth1/1	Eth1/4	00:1b:21:3a:45:d6
Port Descr			enp4s0
Mgmt IP	192.168.10.254	192.168.10.254	192.168.10.231
Primary VLAN	0	0	0

Figure 5-7: LLDP Info Instrument

When you enable LLDP send and receive, the unit searches for neighboring LLDP-enabled devices connected to SFP A, SFP B and the Management Port. The unit reports the following data items:

- System Name
- System Description
- Chassis ID
- Port ID
- Port Description
- Management IP Address
- Primary VLAN ID

The unit can provide the following information over LLDP:

Table 5-2 : LLDP Information Provided

Item	Unit Reports
System Name:	Serial number
System Description:	PHABRIX Qx and Software Version Number
Chassis ID and subtype:	Unit Management MAC address
Port ID and subtype:	Unit Management MAC address
Port Description:	<ul style="list-style-type: none">• Eth0 (Management)• phabEth0 (SFP A)• phabEth1 (SFP B)
Management IP Addresses:	Management IP address

Instrument Menu Options

The unit provides the ability to restrict some of the information that is communicated over LLDP, for example, when considering the IT security of your system. These options are enabled, by default, to allow routine maintenance.

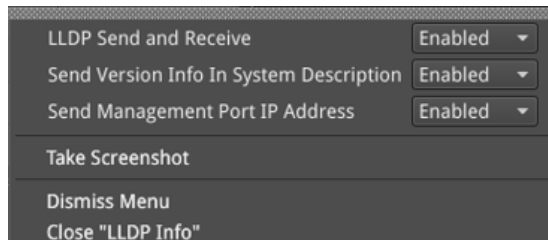

Figure 5-8: LLDP Info Menu Options

If you disable the option **Send Version Info in System Description**, the system description will indicate only **PHABRIX Qx** and will not advertise the software version number. If you disable the option **Send Management Port IP Address**, the unit will not advertise its management IP address.

SFP (A, B) - Info (IP Modes)



Overview

The **SFP - Info** windows provide at-a-glance physical status information on each SFP module, including Identifier, Connector, line code (Encoding), Vendor details and approval status for use with the unit. More detailed status information for the SFP, such as temperature and voltage are also displayed.

SFP A - Info		Temperature: 42.9 °C Voltage: 3.21 V Rx Power: 0.52 mW Tx Power: 0.46 mW	
Status	Approved	Link Length OM4 / Copper (10m / m)	0
Vendor	Gigalight	Bit Rate (Mbd)	10300
Part No	GPP-85192-SRC	Optical Wavelength (nm)	850
Vendor OUI	24-00-00	Temp High Warning (°C):	80.0
Revision	1.0	Temp Low Warning (°C):	-5.0
Serial No	M1802235564	Temp High Alarm (°C):	85.0
Identifier	SFP or SFP+	Temp Low Alarm (°C):	-10.0
Ext Identifier	GBIC/SFP function via two-wire only	Voltage High Warning(V)	3.60
Connector Type	LC	Voltage Low Warning (V)	3.00
Encoding	64B/66B	Voltage High Alarm (V)	3.70
10G Ethernet	10G Base-SR	Voltage Low Alarm (V)	2.90
Fibre Channel Link Length	Short Distance (S)	Tx Power High Warning (mW):	1.26
Fibre Channel Technology	Shortwave laser w/o OFC (SN)	Tx Power Low Warning (mW):	0.13
Fibre Channel Transmission Media	Multimode 62.5µm (M6), Multimode 50µm (M5/M5E)	Tx Power High Alarm (mW):	1.58
Rate Identifier	Unspecified	Tx Power Low Alarm (mW):	0.10
Link Length Smf (km)	0	Rx Power High Warning (mW):	0.79
Link Length Smf (m)	0	Rx Power Low Warning (mW):	0.05
Link Length OM1 (m)	300	Rx Power High Alarm (mW):	1.00
Link Length OM2 (m)	300	Rx Power Low Alarm (mW):	0.04
Link Length OM3 (m)	0		

Figure 5-9: SFP (A, B) - Info Instrument

Instrument Menu Options

Temperature and Power display units can be adjusted using the right-click submenu:

- Temperature Units > [°C, °F]
- Optical Power Units > [mW, dBm]

Overview

Requires Option(s):	PHQXO-IP-STND
---------------------	---------------

The AMWA NMOS toolset supports **IS-04 Discovery and Registration** (versions 1.0, 1.1, 1.2 and 1.3) and **IS-05 Device Connection Management** (versions 1.0 and 1.1). Support is also provided for the discovery of PTP Domain Number by way of **IS-09 System Discovery**. The unit supports both multicast DNS (mDNS) and unicast DNS-SD as described in the JT-NM TR1001-1:2018 requirements.

NMOS connections are defined using Session Description Protocol (SDP) transport files. The NMOS Instrument displays either one or two SDP records, depending on how the NMOS Receiver is configured. If the unit is configured for an NMOS dual interface, SFP A and SFP B interfaces are treated as a pair, and only one SDP record is displayed with SFP A as the designated Primary interface. If the unit is configured for NMOS single interfaces, then SFP A and SFP B are treated individually and separate SDP records are displayed for each interface. For more information, see *RFC 4566 SDP: Session Description Protocol* and SMPTE ST 2110-20, -30, -31 and -40.

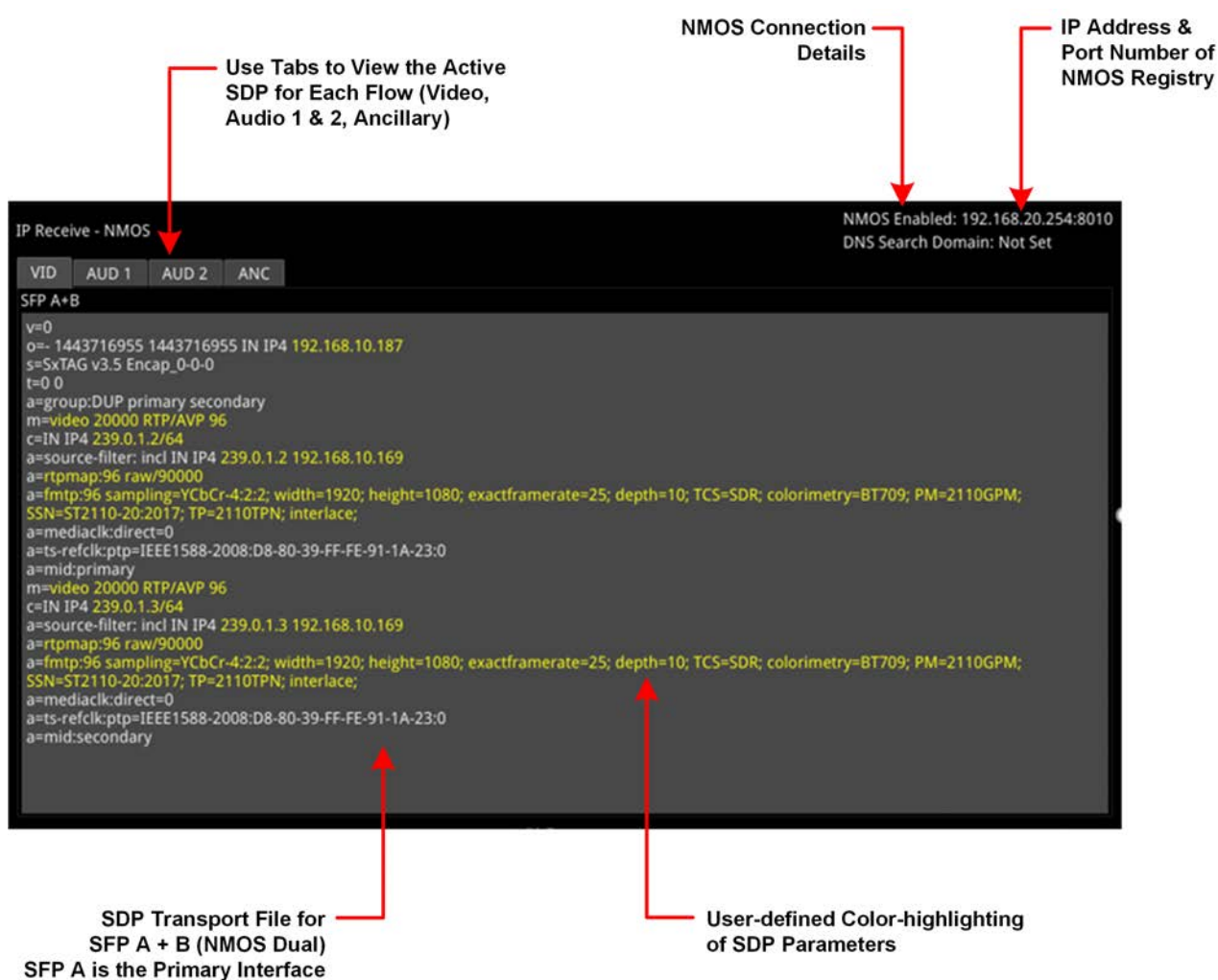

Figure 5-10: IP Receive - NMOS Instrument (Dual Interface) (IP 2110 Mode)

You can use the **IP Receive - NMOS** Instrument to enable your unit to act as an NMOS receiver node. As a component of an NMOS-enabled environment, the unit can register its presence as either a pair

of single nodes, or a dual receiver node, for each flow type, with the Central NMOS Registry. In dual receiver mode, SFP A is the designated primary interface.

Once registered, you can use an NMOS Controller to manage the active connections with the unit. Use the tabs above the SFP A SDP Connection panel to monitor the active video, audio and ancillary SDP transport files.

Note: The unit listens for NMOS communications on UDP Port 3000.

The choice of single/dual NMOS node is independent of the choice of 2022-7 SFP A, SFP B, or Seamless SFP A+B mode selection.

Note: In the event that the unit is unable to locate the NMOS Registry, it will revert to NMOS Peer to Peer mode and display **Peer to Peer** in place of the NMOS Registry IP address and port number.

Any changes to connectivity made by the NMOS Controller are dynamically reflected in the IP Receive - NMOS Instrument.

If you are not using DHCP and are configuring the system by specifying the DNS Server manually, do so in the SFP IP Network instrument, see ["SFP IP Network" on page 5-8](#).

Note: The unit supports 24-bit audio in 2110-30 (PCM) and 32-bit audio in 2110-31 (AES3).

Instrument Menu Options

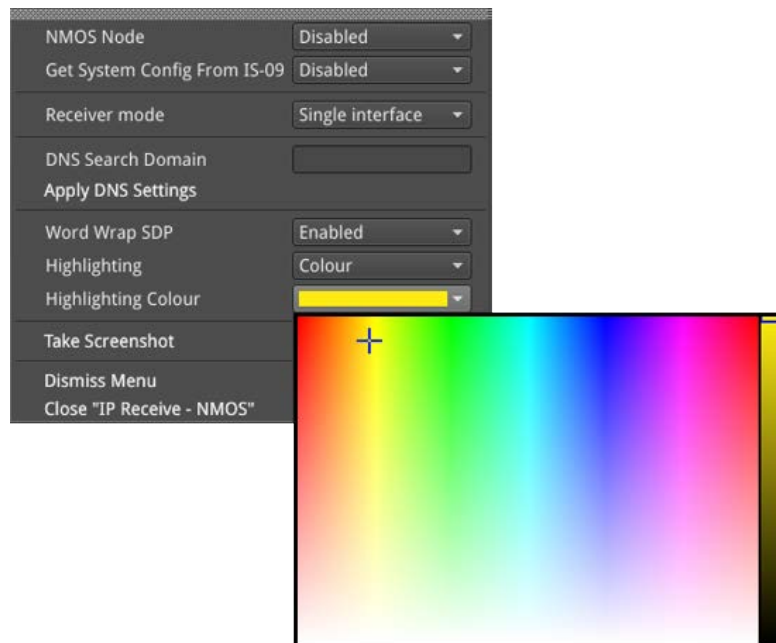

Figure 5-11: IP Receive - NMOS Instrument Menu Options

The following table lists the options available in the IP Receive - NMOS instrument submenu:

Table 5-3 : IP Receive - NMOS Menu Options

Item	Options	Description
NMOS Node	Enabled Disabled (Default)	When enabled, allows the unit to act as an NMOS Node , and announce itself as a receiver to the Central NMOS Registry.
Get System Config From IS-09	Enabled Disabled (Default)	When enabled, the unit will obtain the PTP domain from

Item	Options	Description
		the IS-09 system source. This allows you to choose whether to set network parameters locally on the unit, or centrally from the NMOS Registry.
Receiver mode	Dual interface Single Interface	This option enables you to select whether the unit registers itself as either a single or dual receiving interface. When single, each interface is displayed as a single entity in the NMOS Controller. When dual, the interfaces are displayed as a pair in the NMOS Controller, with SFP A as the designated primary. When prompted, confirm your change.
DNS Search Domain	Blank (default) or free text entry field.	When left blank, the unit uses multicast DNS (mDNS). If you wish to use unicast DNS-SD, enter the required name of the DNS Search domain manually, using an external USB keyboard. After manually entering a DNS Search Domain, click Apply DNS Settings .
Word Wrap SDP	Enabled (Default) Disabled	When enabled, uses word wrap to display the full SDP text descriptions in the available width of the display window. When disabled, you will need to use the horizontal scroll bar(s) to read long SDP descriptions.
Highlighting	None Monochrome Color	Select Color to open the color palette from which you can select the most appropriate color in which to highlight those SDP data parameters, most pertinent to the unit's setup, for example, the source and destination IP addresses, video and audio setup parameters, etc. Select Monochrome to highlight in gray those SDP data parameters, most pertinent to the unit's setup. The highlighting option and any selected color can be saved with the presets.
Highlighting Color	Select from color palette.	Choose a highlight color from the color palette in which to display SDP data parameters.

SFP A/B - PTP Info (IP 2110 Mode)



Overview

Requires Option(s):	PHQXO-IP-STND
----------------------------	----------------------

The unit supports SMPTE protocol ST 2059 Precision Time Protocol for the synchronization of media across an IP network. You can choose to receive either a single active PTP reference feed or dual PTP reference feeds into both SFPs, with one being the active system reference and the other a standby system reference.

If using dual PTP feeds, you can display a **SFP A/B - PTP Info** instrument for each SFP.

You can select the system reference in the **Video Timing & System Reference** Instrument. Use the **System Reference** dropdown list to select either PTP SFP A, PTP SFP B or Free Run.

The selection of IGMP Max Version in the **SFP IP Network** instrument affects all IGMP requests, including PTP and Media Flows requested in the **IP Receive - Flow Select** Instrument.

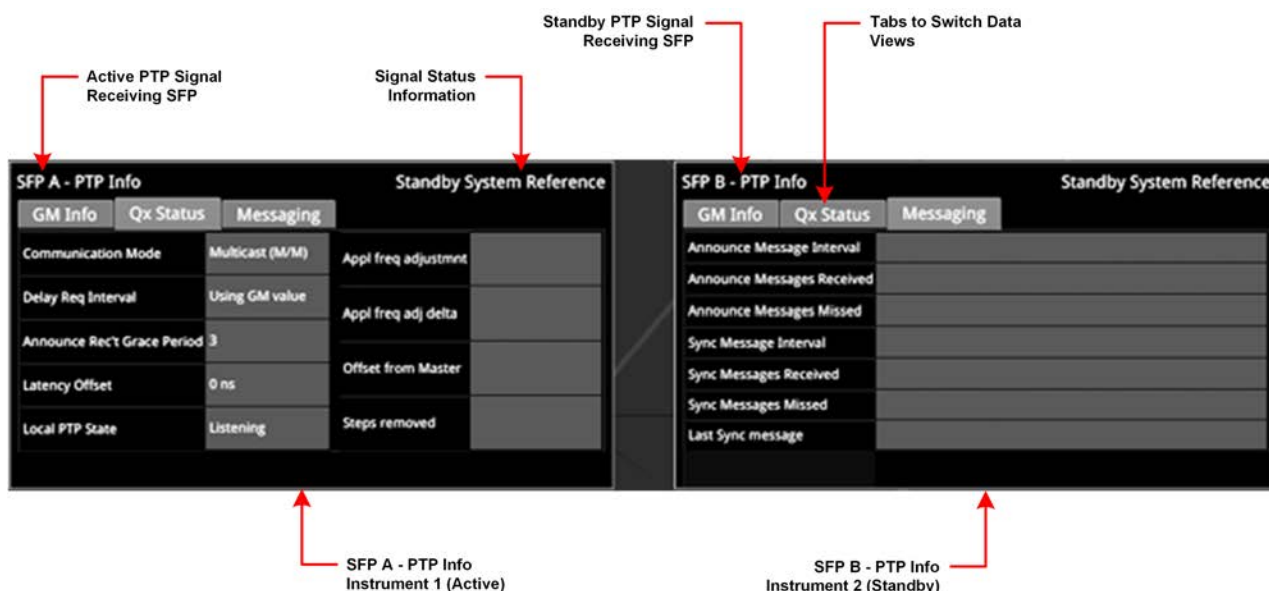

Figure 5-12: Dual SFP A and B - PTP Info Instruments (IP 2110 Mode)

The SFP A/B - PTP Info Instrument features include:

- Control of the PTP Grandmaster (GM) domain and communication mode (Multicast (Multicast/Multicast) or SMPTE Mixed without negotiation (Multicast/Unicast))
- Indication of PTP lock status
- GM information including Master ID and Best Master Clock Algorithm (BMCA) parameters
- Indication of estimated frequency and phase lock offset
- Indication of one-step or two-step sync traffic.

The PTP Info status information at the bottom of the screen indicates which SFP is in use and the state of PTP lock, which you can interpret using the information in the following table:

Table 5-4 : PTP Information Status Messages

PTP Info Status Message	PTP Info Status Color	PTP Lock State
Listening	Red	The PTP Follower is listening on the selected domain number, but has not acquired a PTP Leader or PTP Delay Request information.
Frequency Lock	Yellow	The PTP Follower has acquired a PTP Leader and has achieved frequency lock. The Estimated Phase offset is greater than 2 μ s.
Frequency and Phase Lock	White	The PTP Follower is frequency locked and the estimated phase offset is less than 2 μ s.
In Holdover	Yellow	The PTP Follower had acquired lock, but has now lost the PTP Leader and is in frequency holdover.
Recovered from Holdover	Yellow	The PTP Follower has recovered from a holdover condition where the GM was lost but subsequently re-acquired.

Use the **Clear Warnings** button in the Instrument submenu to remove any yellow warning messages that may be displayed following changes to the PTP lock.

The **SFP A/B - PTP Info** Instrument provides detailed information about the PTP reference signal in the following three tabs:

- **GM Info:** Provides information about the PTP Grandmaster clock to which the system is locked on SFP A and / or SFP B.
- **Qx Status:** Provides information about the configuration, operating mode and status of the unit with respect to the PTP reference signal, together with an indication of the quality of the lock to PTP.
- **Messaging:** Provides information about the timing and number of Announce and Sync PTP messages received from the Grandmaster.

The content of each tab in the SFP A/B - PTP Info Instrument is described in the following sections:

GM Info Tab

The **GM Info** tab reports the following data elements relating to the PTP clock signal received from the Grandmaster:

Table 5-5 : Grandmaster Information Tab

Data Element	Description
Domain	The domain number of the current synchronization domain, in the range 0 (default) to 127.
Master ID	Identity attribute of the Grandmaster clock.
Priority 1	The Priority 1 attribute of the Grandmaster clock in the range 0 to 255 with the lower value having the highest priority.
Priority 2	The Priority 2 attribute of the Grandmaster clock in the range 0 to 255 with the lower value having the highest priority.
Clock Class	The traceability of the time or frequency distributed by the clock, provided as a numerical value identifying the clock state.

Data Element	Description
Clock Accuracy	Indicates the expected accuracy of the clock. For example: < 250 ns
Variance	Provides an indication of the quality of the Grandmaster Clock.
Clock Source	The source of time used by the Grandmaster clock, for example, GPS.
PTP Time	Actual PTP time received from the Grandmaster to which the unit is aligned. For example: 2020-09-16 11:00:00 (UTC)

Qx Status Tab

The **Qx Status** tab reports the following data elements relating to the current PTP status of the unit:

Table 5-6 : Qx Status Data Tab

Data Element	Description
Communication Mode	Current setting of the unit. For more information, or to change the setting, see the section "Instrument Menu Options" on the next page
Delay Req Interval	Current setting of the unit. For more information, or to change the setting, see the section "Instrument Menu Options" on the next page
Announce Rec't Grace Period	Current setting of the unit. For more information, or to change the setting, see the section "Instrument Menu Options" on the next page
Latency Offset	Current setting of the unit. For more information, or to change the setting, see the section "Instrument Menu Options" on the next page
Local PTP State	Current status of the unit with respect to the PTP signal, for example, Listening.
Appl Freq Adjustmnt	The Applied Frequency Adjustment is the adjustment, in parts per billion, made to the unit's clock to make it frequency-locked to the clock of the Grandmaster, that is, both clocks are at the same frequency but not necessarily at the same phase. This value is calculated in software.
Appl Freq Adj Delta	The Applied Frequency Adjustment Delta is the change (delta) to the Applied Frequency Adjustment in the last second. When in lock, this will typically be 0 or 1 part per billion. This value is calculated in software.
Offset from Master	The estimated phase offset between the Grandmaster clock and the local follower clock, for example, - 200 ns.
Steps Removed	The number of IP hops between the Grandmaster and the local follower clock. If the unit were connected directly to the GM, the value would be 1.

PTP Messaging Tab

The **Messaging** tab reports the following data elements relating to the receipt of Announce and Sync messages from the Grandmaster:

Table 5-7 : Messaging Data Tab

Data Element	Description
Announce Message Interval	The Grandmaster sends out Announce messages to provide listening nodes with information about the sending clock. The Announce Message Interval is the time between consecutive Announce messages. This value is signalled by the GM and reported by the unit.
Announce Messages Received	The number of Announce messages received from the Grandmaster to which the unit is locked.

Data Element	Description
Announce Messages Missed	The number of Announce messages sent from the Grandmaster that were not received by the unit.
Sync Message Interval	The Grandmaster sends out Sync messages, which it uses to calculate the offset from the Master and to make adjustments. This value is signalled by the GM and reported by the unit.
Sync Messages Received	The number of Sync messages received from the Grandmaster to which the unit is locked.
Sync Messages Missed	The number of Sync messages sent from the Grandmaster that were not received by the unit.
Last Sync Message	The state of the two-step flag in the last sync message indicating one-step or two-step. A two-step flag indicates that there is a follow-up message containing the time-stamp, whereas a one-step flag indicates that the time-stamp is included as part of the Sync Message.

Instrument Menu Options

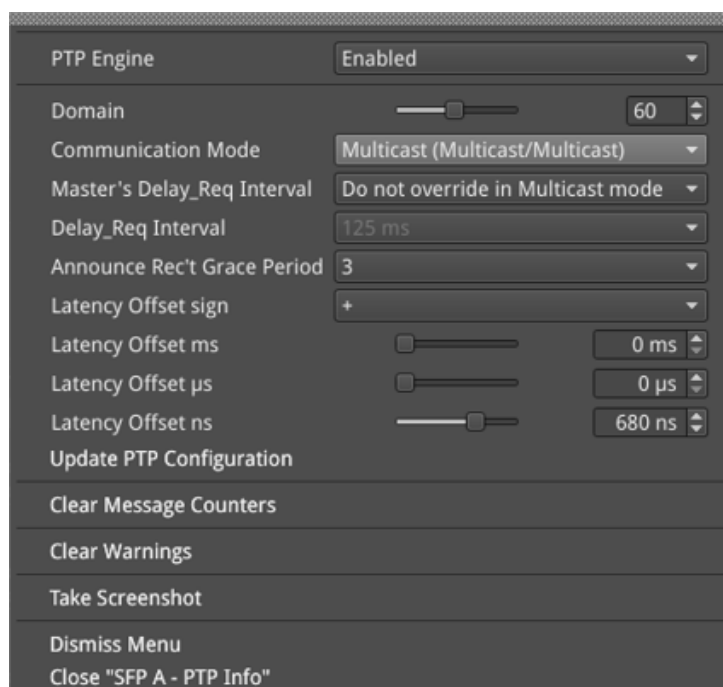

Figure 5-13: SFP A/B - PTP Info Instrument Menu Options

The following table lists the options available in the SFP A/B - PTP Info instrument submenu:

Table 5-8 : SFP A/B - PTP Info Menu Options

Item	Options	Description
PTP Engine	Enabled (Default) Disabled	When disabled, switches off the PTP engine on the corresponding SFP to stop listening to PTP messages on that interface. You can select which SFP to use as the current, active PTP engine using the System Reference dropdown in the options menu of the Video Timing & System Reference instrument.
Domain	0 (default) to 127	Defines the IP domain in which the PTP GM is located.
Communication Mode	Multicast (Multicast/Multicast) SMPTE Mixed (Multicast/Unicast)	The unit supports two PTP communication modes: <ul style="list-style-type: none"> • Multicast mode (Multicast Announce and Sync, Multicast Delay Request, Delay Response) • SMPTE Mixed mode without negotiation (Multicast Announce and Sync, Unicast Delay Request, Delay Response) In Multicast mode, you can set the unit automatically to adopt the Master Sync message rate for its multicast Delay Request message rate, by setting the unit's Master's Delay_Req interval option to Do not override in Multicast mode . Alternatively, you can set the Delay Request message rate to manual control by setting the unit's Master's Delay_Req interval option to Override in all modes . In SMPTE Mixed mode the Delay Request message rate is always under manual control.
Master's Delay_Req Interval	Do not override in Multicast Mode (Default) Override in all modes	In Multicast Mode, the default Delay_Req interval is set to be the same as the Master Sync message interval.
Delay_Req Interval	8 ms, 16 ms, 32 ms, 64 ms, 125 ms (Default), 500 ms, 1 s, 2 s, 4 s	Allows you manually to define a Delay Request (Delay_Req) message interval, that is, the rate at which Delay_Req messages are sent. When you set the Communication mode to SMPTE Mixed or Multicast (MM) and enable Override in all modes, this is the rate at which the unit sends Delay_request messages back to the Grandmaster.
Announce Rec't Grace Period	2 - 10 (× Announce Timeout) Default: 3 × Announce Timeout	A Grandmaster transmits a PTP Announce Message to indicate its presence on the network. Accompanying this message is the signaled Announce Message Rate and the Announce Timeout Count. A PTP follower, such as this unit, uses this information to confirm that the Master is still present and active. If the unit experiences a set of missing Announce messages greater than the Announce Timeout Count, then it will assume that the PTP Master is missing and will attempt to re-lock. The time for this count to trigger is the Announce Timeout . The Announce Receipt Grace Period is a user-definable delay that is equal to the selected value multiplied by

Item	Options	Description
		the Announce Timeout. This delay period allows for a seamless Grandmaster change-over before the unit attempts to re-acquire PTP lock. The default setting is three times the Announce Receipt timeout but you can choose between two to ten times the Announce Receipt timeout interval.
Latency Offset sign	+ -	Sets the Latency Offset as an increase (positive (+) value) or decrease (negative (-) value.)
Latency Offset (ms, μ s, ns scales)	User Defined	The long term PTP phase alignment of the unit can be affected by network delay asymmetries or, for example, by conversion between a 1 G PTP source and a 25 G network. You can adjust this long-term PTP phase offset by comparing the 1 PPS from the unit on the GPI output with the 1 PPS from the PTP Grandmaster on an oscilloscope. You can then adjust the unit's PTP Latency Offset control sliders accordingly to bring the unit's 1 PPS into time alignment with the 1 PPS of the Grandmaster. The value of the PTP Latency offset is reported in the Qx Status tab of the PTP Info instrument.
Update PTP configuration	System Control	Applies any changes after updating the PTP settings.
Clear Message Counters	System Control	Resets all message counters to zero, for example, resets the counters Announce Messages Received and Sync Messages Received.
Clear Warnings	System Control	Removes warning messages from the status line at the bottom of the Instrument window.

The Delay Request message rate options are as follows:

Table 5-9 : Options for the Delay Request Message Rate

Delay_Req Interval	Delay Request Messages/Second
8 ms	125
16 ms	62.5
32 ms	31.25
64 ms	15.625
125 ms	8
250 ms	4
500 ms	2
1 s	1
2 s	0.5
4 s	0.25



Overview

The **Video Timing & System Reference** Instrument provides measurements that enable you to assess the timing quality of the Qx input relative to a selected reference. If necessary, you can then set timing offsets against which to measure. The measurements and adjustment tools available depend on the current mode of the Qx and whether the inputs are received from an SDI or IP system, as summarized in the following table.

Table 5-10 : Overview of IP Video Timing Functions by License and Boot Mode

		Qx Boot Mode	
		IP ST 2022-6	IP ST 2110
PHQXO -IP-STND License	Decapsulated vs System Reference		
	External Reference vs PTP		

Timing in IP 2022-6 Mode: Decapsulated vs System Reference

In IP 2022-6 Mode, the upper section of the **Video Timing & System Reference** instrument window compares the timing of the Decapsulated input against a selected System Reference to which the Qx is locked. You can select the System Reference from External or Free Run reference signals. The upper section of the Instrument displays the following resulting measurements in both spatial units (lines and pixels) and time (μ s or ns):

- Measured Timing
- Offset to Apply (with External Reference only)
- Offset Timing (with External Reference only.)

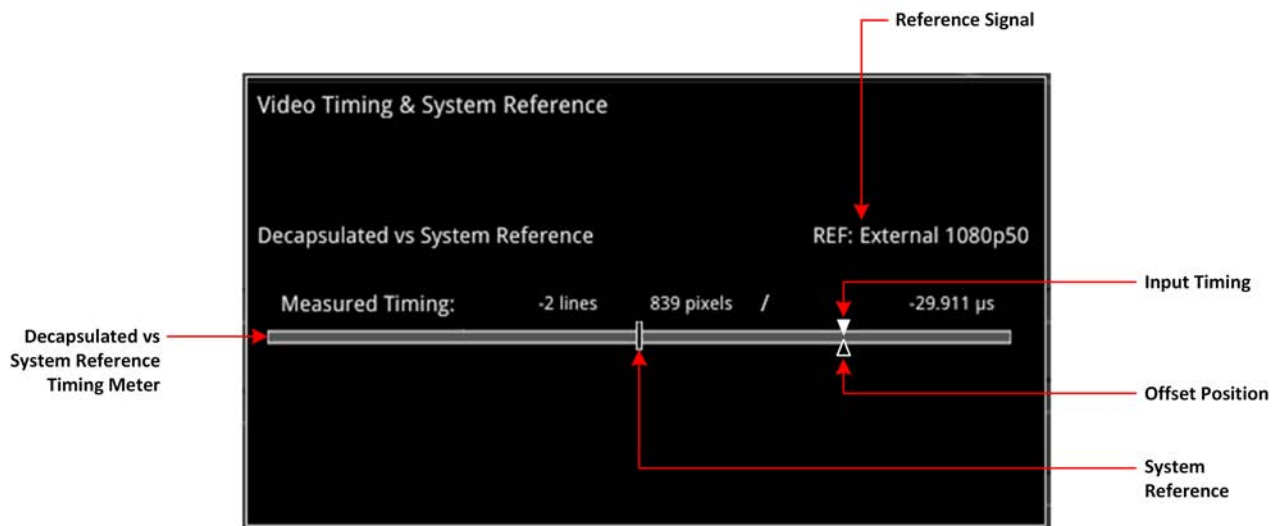

Figure 5-14: Video Timing & System Reference Instrument (IP 2022-6 Mode)

A timing meter dynamically measures the timing of the input (white triangle) against the system reference (centrally fixed, black vertical rectangle). In addition to measuring the input against an absolute system reference, you can choose to apply a system reference offset against which to measure. The position of any offset is shown on the timing bar as a black triangle.

Instrument Menu Options

The following table lists the options available in the Video Timing & System Reference instrument submenu:

Table 5-11: Video Timing & System Reference Menu Options (IP 2022-6 Mode)

Item	Options	Description
System Reference	Free Run External Reference	System reference locking controls define the reference to which the Qx and any signal it generates is locked. By selecting the default option Free Run, the system locks to the internal Qx oscillator as the timing reference signal. If the system loses the external reference signal for some reason, the system will automatically switch to use the Free Run reference signal. System reference lock status information is displayed in the upper-right corner of the instrument, and any error in the health state of the reference is displayed in red.
Reference Timing Meter Range	+/- 0.1 line, +/- 0.5 line, +/- 0.5 frame	Adjusts the displayed range of the reference timing meter in the upper section of the Instrument to display readings at frame scale, or to zoom in to a fraction of a line.
Input Measurement Offset Type	Lines And Pixels Time	Defines whether to apply an offset using spatial (lines/pixels) or temporal (μ s, ns) values.
Input Measurement Time Offset	0.00, +/- 0.01, etc...	For Time as the offset type, set the timing offset in microseconds (μ s).
Input Measurement Line Offset	0 to +/- (Total number of Lines in the current standard minus one.)	For Lines And Pixels as the offset type, set the course timing offset as a number of lines.

Item	Options	Description
Input Measurement Pixel Offset	0 to +/- (Total number of Pixels per Line in the current standard minus one.)	For Lines And Pixels as the offset type, set the fine timing offset as a number of pixels.
Set Input Measurement Offset to current	N/A	Sets the input measurement offset to the same position as the current Decapsulated signal.
Clear Input Measurement Offset	N/A	Removes any input measurement offset.

Video Timing & Setting External Reference in IP 2110 Mode

Requires Qx Option(s):	PHQXO-IP-STND
------------------------	---------------

Overview

In IP 2110 Mode, the **Video Timing & System Reference** instrument must be stably locked to the same PTP source as the sending device. The **Video Timing & System Reference** window includes the following two tabs, each providing access to different timing data:

- Media Latency (for more information, see section ["Video Timing & System Reference \(IP 2110 Mode\)" on page 5-38](#))
- External Reference vs PTP

External Reference vs PTP Tab

The **Ext Ref vs PTP** tab is a timing tool for use in a hybrid system to compare the external analog reference to the PTP reference. The system reference must be set to PTP and the Qx PTP lock must be stable with a low PTP Estimated Phase Offset for this measurement to be valid.

The time difference between the external analog reference and PTP is displayed both in units of video lines and pixels, and units of time (μ s or ms.)

The accuracy of this measurement is dependent on the long term PTP phase alignment of the Qx. This can be affected by network delay asymmetries or by conversion between a 1G PTP source and a 10G network.

You can adjust this long-term PTP phase offset by comparing the 1PPS from the Qx on the GPIO with the 1PPS from the PTP Grandmaster on an oscilloscope and adjusting the Qx PTP Latency Offset controls in the submenu of the **PTP Info** Instrument to bring the Qx 1PPS into time alignment with the 1PPS of the Grandmaster.

The tab displays any offset between an external reference signal and the PTP reference. It shows this value in units of time as well as in lines and pixels. If the external reference originates from the same source as PTP then the value displayed should represent the phase offset of the Qx. Use this tool to show how well your external reference is locked to PTP. If it is not locked to PTP, you will notice the value drifting.

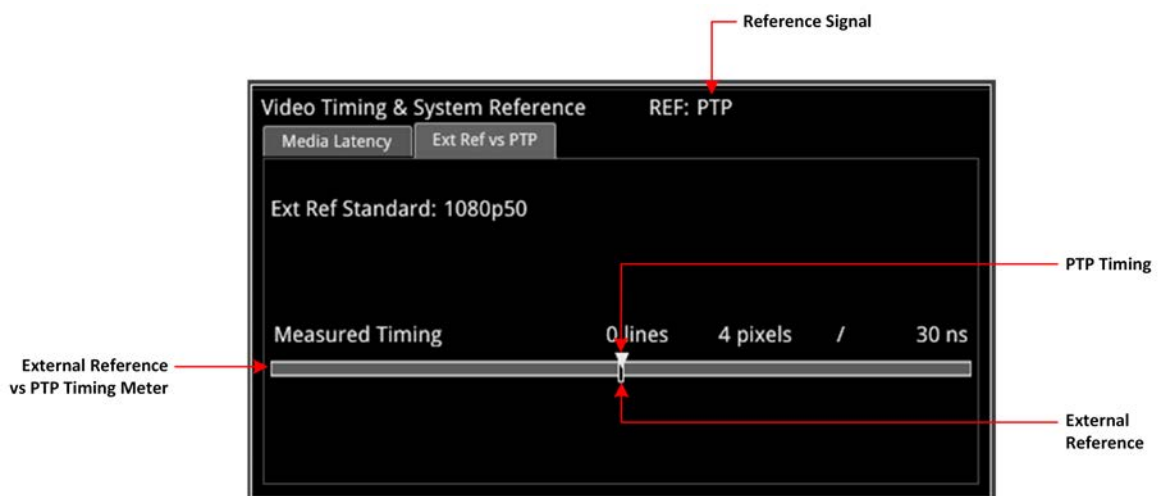

Figure 5-15: Ext Ref vs PTP Tab of the Video Timing & System Reference Instrument (IP 2110 Mode)

Instrument Menu Options

The following table lists the options available with a standard core license in the **Video Timing & System Reference** Instrument submenu in IP ST 2110 Mode:

Table 5-12 : Video Timing & System Reference Menu Options (2110 Mode)

Item	Options	Description
Ext Ref vs PTP Tab Options		
System Reference	PTP External Reference	<p>System reference locking controls define the reference to which the Qx and any signal it generates is locked. In IP 2110 mode, make sure that the system reference is stably locked to the same PTP source as the sending device.</p> <p>System reference lock status information is displayed in the upper-right corner of the instrument, and any error in the health state of the reference is displayed in red.</p>
Reference Timing Meter Range	+/- 0.1 line, +/- 0.5 line, +/- 0.5 frame	Adjusts the displayed range of the reference timing meter in the upper section of the Instrument to display readings at frame scale, or to zoom in to a fraction of a line.
Media Latency Tab Options		
Latency Meters Zoom	Overview, A VID, A AUD 1, A AUD 2, A ANC, B VID, B AUD 1, B AUD 2, B ANC	Select a specific timing meter to switch between overview and zoomed-in view.
Anchor time scale start in Overview mode	Zero (0) or less, Any value	Set the start point of the timescale when in Overview.
Clear Min, Max values	N/A	Set the historical minimum and maximum values back to zero.



Requires Option(s):	PHQXO-IP-STND
---------------------	---------------

Overview

The **IP Receive - Flow Select** window enables you to instruct the unit to issue an IGMP request manually, categorize each received flow SMPTE protocol type, and then select IP flows for analysis. The Multicast Requests table lists the IP flows together with their parameters. The IP flows include those that match multicasts to which the unit has subscribed, together with multicast and unicast flows that have been sent to the unit.

When under AMWA NMOS control, the unit automatically issues an IGMP request, categorizes and selects a flow, all under the control of a Session Description Protocol (SDP) transport file.

In IP ST 2110 mode the unit can simultaneously process the following:

- One video flow
- Two audio flows
- One ANC flow.

The audio flows may be either ST 2110-30 (PCM) or ST 2110-31 (AES 3).

In ST 2022-6 mode, you can select one flow at a time for processing. Allocation of a media flow type or protocol is independent of the Payload Type ID number, so it is possible to have several different media flow types with the same Payload Type ID.

Detailed information for each flow is provided in the Multicast Requests table as follows:

- SFP Port (A or B)
- Channel Allocation (Video, Audio 1, Audio 2, ANC)
- SMPTE Media Protocol (2110-20, -30, -40, etc.)
- Payload Type ID Number
- Destination and Source IP Addresses and Port Numbers
- Synchronization Source (SSRC) Identifier
- Mean Flow Bandwidth averaged over 1 second
- Total Packet Counts
- Sequence Error Count.

Both Sequence Payload and CRC errors are displayed in the **Seq errors** count column. You can sort the table by any parameter column, and once configured, left-click a flow for further analysis.

The overall status of the Multicast IGMP requests is displayed above the table, for example: Multicast Requests: 18/18 joins sent. Multicast IGMP join and leave requests can be controlled using the submenu, and the maximum level of IGMP requests can be configured in either the **PTP Info** or **SFP IP Network** Instruments.

Flow protocol configuration management is available from the submenu, and incoming flows with unassigned protocols (Other IP) can also be quickly configured by right-clicking the flow, then assigning the flow type and analysis path in the configuration window.

In IP ST 2110 mode, **IP Receive - Flow Select** supports the reception of flows on SFP A or SFP B as well as ST 2022-7 Seamless IP Protection Switching (SIPS) of pairs of flows on SFP A + B. In ST 2022-6 mode the reception of IP media flows is available on SFP A, with SFP B reserved for transmission.

Note: SIPS protection of a flow pair is available across SFP A + B, however, SIPS protection of a flow pair within a single SFP is not supported.

IP Receive - Flow Select										Analyser Interface: SFP A
Multicast Requests: 16/16 joins sent										
SFP	Sel	Protocol	Type	Dst IP	Src IP	SSRC	Bandwidth	Packets	Seq errors	
A		2110-20	96	239.141.20.1:20000	192.168.10.141:10000	0	1.091 Gbps	8707159694	0	
A	VID	2110-20	96	239.168.20.1:20000	192.168.10.168:10000	0	1.091 Gbps	3101138620	2	
A		2110-30	97	239.141.30.1:20000	192.168.10.141:10000	0	21.888 Mbps	645007909	0	
A	AUD 1	2110-30	97	239.141.30.3:20000	192.168.10.141:10000	0	2.735 Mbps	80625059	0	
A	AUD 2	2110-30	97	239.168.30.1:20000	192.168.10.168:10000	0	21.888 Mbps	229713938	0	
A		2110-30	97	239.168.30.3:20000	192.168.10.168:10000	0	2.735 Mbps	26318951	0	
A	ANC	2110-40	100	239.141.40.1:20000	192.168.10.141:10000	0	24.669 kbps	4031245	0	
A		2110-40	100	239.168.40.1:20000	192.168.10.168:10000	0	43.371 kbps	1973926	1	
B		2110-20	96	239.141.20.2:20000	192.168.10.141:10000	0	1.091 Gbps	8707220999	0	
B	VID	2110-20	96	239.168.20.2:20000	192.168.10.168:10000	0	1.091 Gbps	3101138640	2	
B		2110-30	97	239.141.30.2:20000	192.168.10.141:10000	0	21.889 Mbps	644978435	0	
B	AUD 1	2110-30	97	239.141.30.4:20000	192.168.10.141:10000	0	2.735 Mbps	80622196	0	
B	AUD 2	2110-30	97	239.168.30.2:20000	192.168.10.168:10000	0	21.886 Mbps	229713939	0	
B		2110-30	97	239.168.30.4:20000	192.168.10.168:10000	0	2.735 Mbps	26318951	0	
B	ANC	2110-40	100	239.141.40.2:20000	192.168.10.141:10000	0	24.671 kbps	4031105	0	
B		2110-40	100	239.168.40.1:20000	192.168.10.168:10000	0	43.373 kbps	1973926	1	

Figure 5-16: IP Receive - Flow Select Instrument Displaying Overview of Multicast Requests Sent

Media flows may have already been presented to the unit either by a unicast sender, a network orchestrator or by the unit being attached to a switch or router mirror port or passive optical tap. In these situations, the details of the media flow are automatically displayed in the Flow Select window.

If the unit is required to initiate a multicast session by way of an IGMP request then this can be achieved either automatically, using either the JSON API or NMOS; or manually, by right-clicking in the **Flow Select** tool and selecting the option **Multicast/Flow Config** from the submenu. This displays a window with two selectable tabs: **Multicast Requests** (see ["Multicast Setup \(Multicast Requests\)" on page 5-31](#)) and **Flow Configuration** (see ["Flow Protocol Configuration \(Flow Config\)" on page 5-33](#)).

The unit can access IP flows using either IGMP v1, v2 or v3 multicast requests, with the maximum level of an IGMP request configured either by right-clicking on the Flow Select or alternatively in the **PTP Info** or **SFP IP Network** Instrument submenus. The selected maximum IGMP multicast level is applied to all media ports. Once a multicast group is successfully joined, all flows within it will appear in the **IP Receive - Flow Select** window.

The IP flows with assigned SMPTE protocols listed in the window are those currently available for selection on the chosen interfaces. Click to select a flow for analysis; the selected flow is then highlighted.

Instrument Menu Options

The submenu, accessed by right-clicking the **IP Receive - Flow Select** window, calls-up multicast and flow configuration settings, persistence settings, together with list and selection clearing controls.

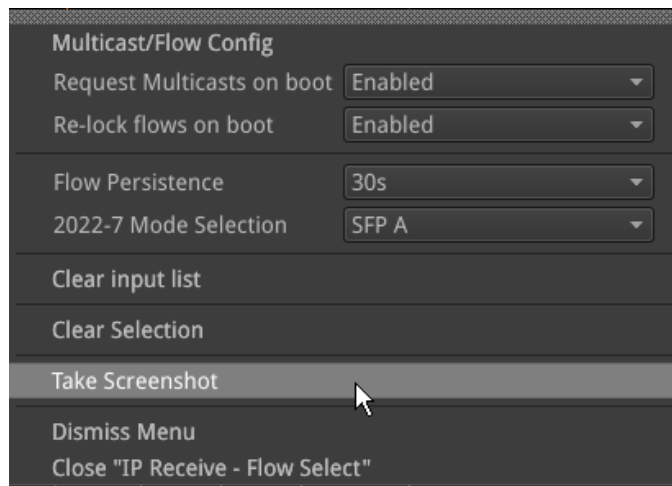

Figure 5-17: IP Receive - Flow Select Instrument Options Menu

The following table lists the options available in the IP Receive - Flow Select Instrument submenu:

Table 5-13 : IP Receive - Flow Select Menu Options

Item	Options	Description
Multicast/Flow Config	Dialog selection	Click to open a new dialog box with tabs for Multicast Requests (see "Multicast Setup (Multicast Requests)" on the facing page) and Flow Config (see "Flow Protocol Configuration (Flow Config)" on page 5-33) as previously described.
Request Multicasts on boot	Enabled (Default) Disabled	When enabled, sets the unit to request to receive Multicast flows automatically on re-boot.
Re-lock flows on boot	Enabled (Default) Disabled	When enabled, sets the unit to re-lock to the selected flows automatically on re-boot.
Flow Persistence	1 s 10 s 30 s 1 min 5 min 10 min Infinite	Sets the amount of time that old, inactive flows remain displayed in the Flow Select window
2022-7 Mode Selection	SFP A SFP B Seamless A+B	Choose whether you want to analyze flows available on one or both SFP receiver interfaces (in IP 2110 mode). The current mode is displayed in the top right-hand corner of the instrument window (Analyzer Interface). In IP 2022-6 mode, a single video flow can be selected for analysis at a time. In IP 2110 mode up to four flows per interface (one video, two audio and one ANC) can be selected at the same time. When ST 2022-7 seamless reconstruction is enabled (Seamless A+B), up to four pairs (eight flows) are simultaneously used by the unit for Seamless IP Protection Switching (SIPS). Identical instances of a flow (in terms of content) must be sent to both SFP interfaces. The unit then reconstructs the flow using the <i>best</i> packets from either interface.
Clear input list	System control	Click to clear the displayed list of available flows.
Clear Selection	System control	Click to deselect the currently analyzed flow(s).

Multicast Setup (Multicast Requests)

To access the **Multicast Setup** dialog, select the **Multicast/Flow Config** option from the Instrument submenu and click the **Multicast Requests** tab if not already selected.

Enter the details of the multicast to join and the desired SFP interface, using the controls in the bottom-right corner of the **Multicast Requests** tab.

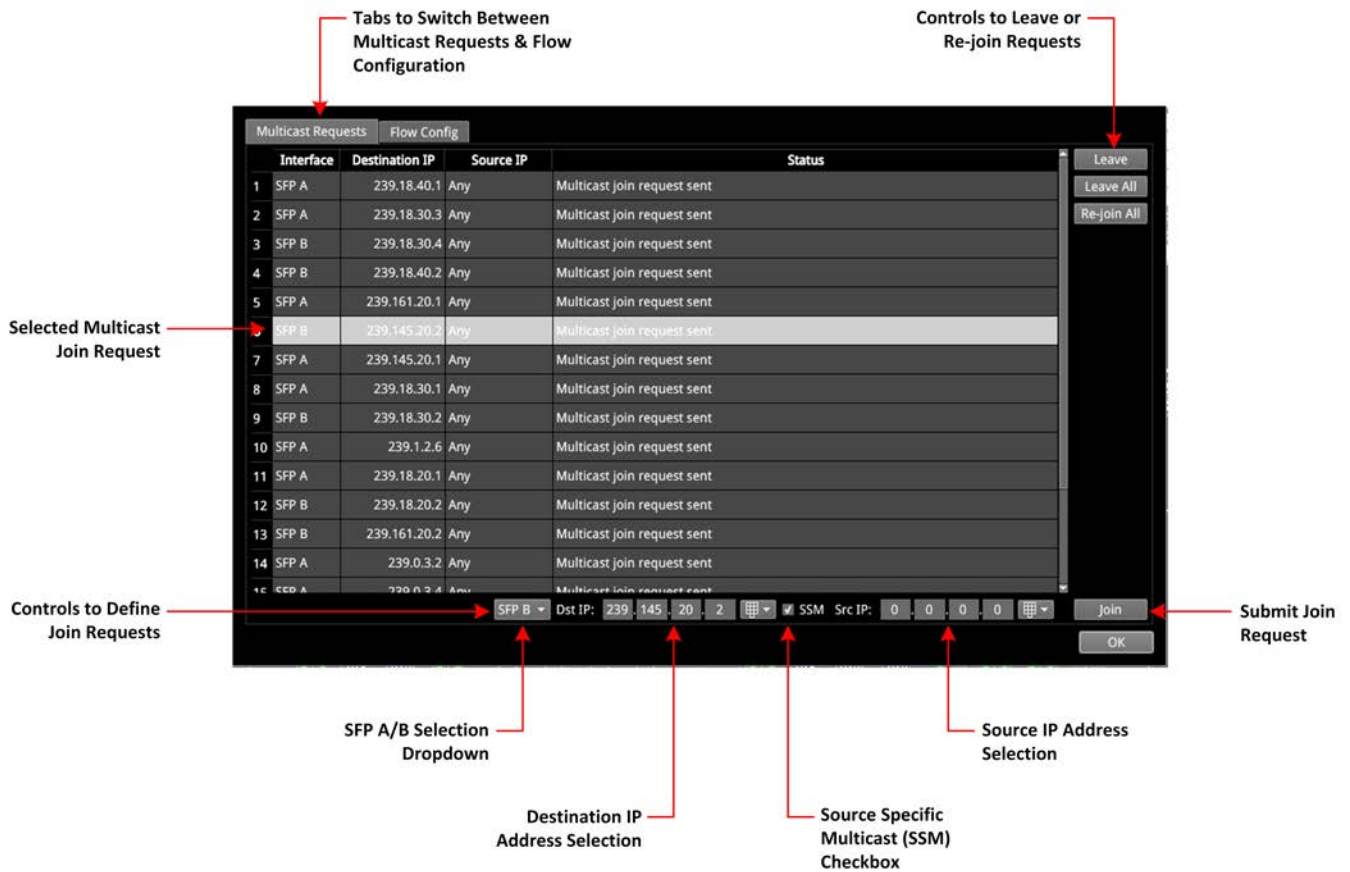

Figure 5-18: IP Receive - Flow Select: Multicast Requests Tab

Using the Instrument Controls

Select interface **SFP A** or **SFP B** from the dropdown list.

Enter the destination IP address of the multicast group to join in the **Dst IP** fields using either a USB keyboard or the soft keypad. Alternatively, hover over the number to adjust and use the mouse scroll wheel to increase or decrease the number within the following range:

- Dst IP: > [224.0.0.1 to 239.255.255.255]

You can choose to use **Source Specific Multicast (SSM)**, in conjunction with IGMPv3, to ensure that the unit receives packets originating from the source IP address that you select. To use SSM, select the **SSM** checkbox.

Note: IGMPv1 and IGMPv2 do not support SSM.

To send the multicast join request, click: **Join**.

This join request is added to the table of multicast requests in the tab dialog window, together with the status of the join request.

To join a multicast already listed in the table, but not joined, or to resend a join request for a multicast that has already been joined, select it and then click **Join**.

To exit a multicast, select it from the table in the dialog box, then click:

- Leave

To exit all multicasts, select:

- Leave All

A prompt window is displayed, asking you to confirm that you want to leave all multicasts.

To request to re-join all multicasts currently listed in the dialog box table, select:

- Re-join All

To close the **Multicast Requests** dialog window, click:

- Ok

To set the unit to request to re-join all multicasts currently listed in the dialog box table, automatically on reboot, return to the instrument submenu and enable the following:

- Request Multicasts on boot > [Enabled, Disabled]

Flow Protocol Configuration (Flow Config)

Having successfully joined a multicast, or if media traffic has already been routed to the unit, then all the associated flows will be visible in the **Flow Select** table.

The multi-flow nature of SMPTE ST 2110 means that a fairly complex labeling procedure is required to identify the various flows and their specific parameters. Before using an incoming IP flow in ST 2110, it is important first to identify the type of SMPTE protocol flow you are dealing with, in order to analyze it correctly.

If an IGMP join has been initiated under NMOS control, then all flow parameters will be automatically configured using the information in the Session Description Protocol (SDP) transport file.

If a media flow type is unknown to the unit, then the protocol type will be identified as **Other IP**, and this will also automatically appear in the **Unconfigured Flows** table in the **Flow Config** dialog.

Configure the Flow protocol either by left-clicking the **Other IP** label of a flow in the **Flow Select** window, or by using the **Flow Config** tool, which maintains the list of flow protocol configurations.

The unit automatically stores all flow configurations and this list builds up over a period of time. Media flows can also be pre-configured, before being requested.

Using the Flow Config Controls

Select **Multicast/Flow Config** in the Instrument submenu, then click the **Flow Config** tab.

The dialog box displays the following window:

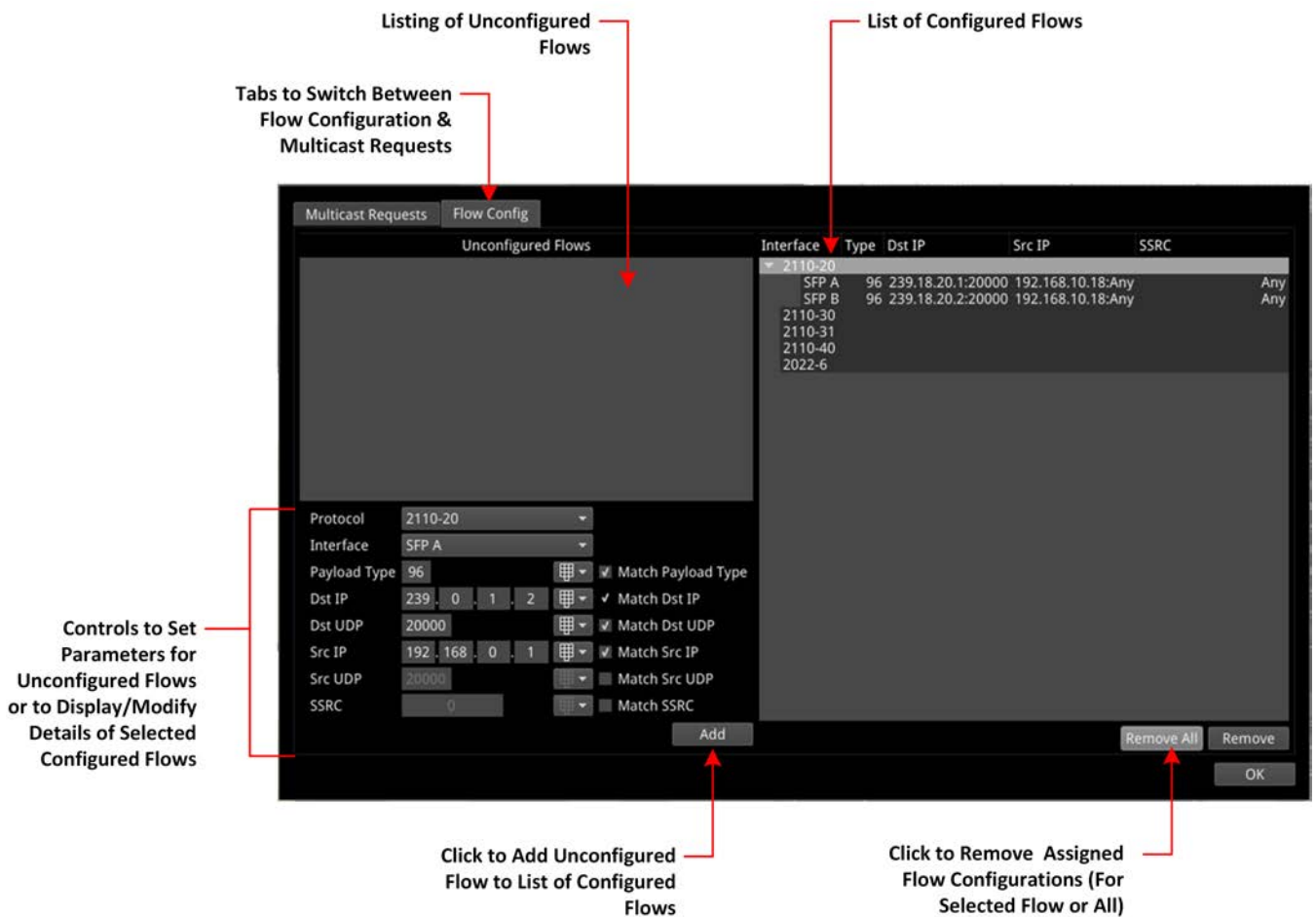

Figure 5-19: IP Receive - Flow Select: Flow Config Tab

- The left-hand pane displays any unconfigured flows together with controls to set any user-controlled parameters that you can apply
- The right-hand pane displays all configured flows, organized by protocol type. If you select a single flow in this pane, the unit populates the flow details in the fields and checkboxes below the Unconfigured Flows pane. In manual operation, only the **Match Destination(Dst) IP** checkbox is checked by default. You can select other checkboxes as required. When a checkbox is unchecked, **Any** is displayed in the corresponding field in the Configured Flows pane.
- When under automatic NMOS control, the following checkboxes are selected by default:
 - Payload Type
 - Destination IP Address
 - Destination UDP Port Number
 - Source IP Address.

To configure a flow, select one in the **Unconfigured Flows** window. Its current parameters populate the flow parameter controls below the panel.

Using the controls, select options as required:

- Protocol > [2110-20 (video), 2110-30/31 (audio), 2110-40 (ANC), 2022-6 (IP 2022-6 mode)]

Where an SSRC ID is included in an available flow, decide whether you want to analyze the flow only when this SSRC is matched.

Once you have configured a flow, click **Add** move it into the right-hand pane of configured flows.

To remove the current configuration assigned to a flow, click **Remove** or click **Remove All** to clear all flow configurations. If you choose **Remove All**, you are prompted to confirm that you want to remove all configured flows. Click **Remove All** to proceed.

If the flow is still present on one of the SFP interfaces, it will appear back in the **Unconfigured Flows** window, where it can be modified, if required.

On completion, click Ok to close the **Flow Config** window.

Analyzer - 2110 Format Setup (IP ST 2110 Mode)



Requires Option(s):	PHQXO-IP-STND
---------------------	---------------

Overview

The **Analyzer - 2110 Format Setup** window is where you should define the video and audio parameters to be applied to the flows selected for analysis in the absence of a Session Description Protocol (SDP) record. You can define parameters for one video flow and two audio flows. Where an SDP record is being used to select a flow, then the format parameters will be populated automatically from the SDP transport file.

Analyzer - 2110 Format Setup			
Video	Audio		
	Configured	Detected	
Picture Dimensions	1920x1080	Audio 1 Packet Time	
Frame Packing	Interlaced	Audio 1 Channels	
Field Rate	50	Audio 2 Packet Time	
Sampling	YCbCr:422	Audio 2 Channels	
Bit Depth	10		
Transfer Curve	SDR		
Colourimetry	BT709		
TRO Default	782.222 μ s		

Figure 5-20: Analyzer - 2110 Format Setup Instrument

Features include:

- User-configurable video format parameters for ST 2110-20 flows
- User-configurable audio format parameters for ST 2110-30 flows includes packet time and channel count
- Automatic detection of audio format, channel count and packet time.

Instrument Menu Options

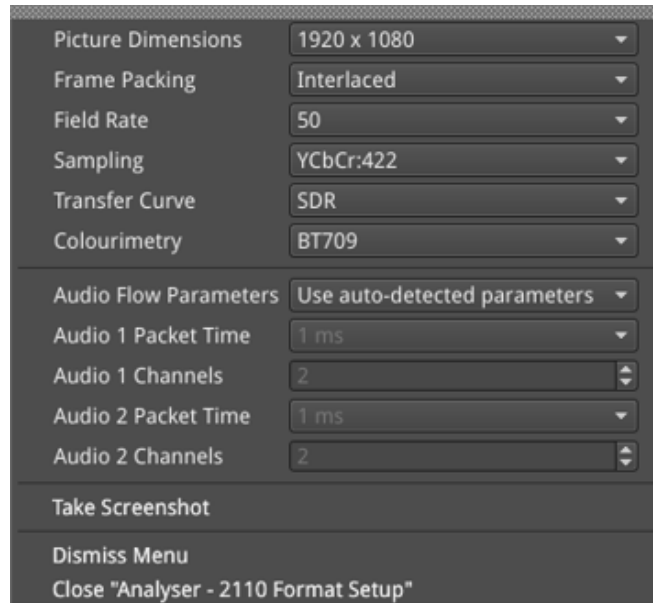

Figure 5-21: Analyzer - 2110 Format Setup Instrument Menu Options

The following table lists the video format parameter options available in the Analyzer - 2110 Format Setup instrument submenu:

Table 5-14: Analyzer - 2110 Format Setup Menu Options

Item	Options	Description
Picture Dimensions	1280 x 720 1920 x 1080 2048 x 1080	Select the appropriate picture dimensions for the flow.
Frame Packing	Interlaced (Default) Segmented Progressive	Select the appropriate frame packing method for the flow.
Field Rate	50 59.94 60	Select the appropriate frame rate for the flow.
Sampling	YCbCr:422	Select the appropriate sampling method for the flow.
Transfer Curve	SDR PQ HLG S-Log3	Select the appropriate transfer curve for the flow.
Colorimetry	BT709 BT2020	Select the appropriate colorimetry standard for the flow.
Audio Flow Parameters	Use auto-detected parameters (Default) Use override parameters	If you select the option Use override parameters , you can manually set the following fields (the maximum number of Channels depends on the Packet Time set):
Audio 1 Packet Time	1 ms 125 μ s	Enabled only when Audio flow parameters option is set to Use override parameters.
Audio 1 Channels	1 to 10	Enabled only when Audio flow parameters option is set to Use override parameters.

Item	Options	Description
Audio 2 Packet Time	1 ms 125 μ s	Enabled only when Audio flow parameters option is set to Use override parameters.
Audio 2 Channels	1 to 10	Enabled only when Audio flow parameters option is set to Use override parameters.

Video Timing & System Reference (IP 2110 Mode)



Overview

The **Video Timing & System Reference** Instrument provides measurements that enable you to assess the timing quality of the input relative to a selected reference. If necessary, you can then set timing offsets against which to measure. The measurements and adjustment tools available depend on the current operating mode of the unit and whether the inputs are received from an IP ST 2022-6 or IP ST 2110 system, as summarized in the following table.

Table 5-15 : Overview of IP Video Timing Functions by License and Boot Mode

		Boot Mode	
		IP ST 2022-6	IP ST 2110
PHQXO -IP-STND License	Decaps vs Sys Ref		Media Latency Tab (Mean Data Column)
			Ext Ref vs PTP
PHQXO -IP-MEAS License	Decaps vs Sys Ref		Video Timing Tab (Full Data)
			Media Latency Tab (Full Data)

Video Timing in IP 2110 Mode

Requires Qx Option(s):	PHQXO-IP-STND
------------------------	---------------

Overview

In IP 2110 Mode, the **Video Timing & System Reference** instrument must be stably locked to the same PTP source as the sending device. The **Video Timing & System Reference** window includes the following two tabs, each providing access to different timing data:

- Media Latency
- External Reference vs PTP

For more information, see section ["Video Timing & Setting External Reference in IP 2110 Mode" on page 5-26](#).

Media Latency Tab

The **Media Latency** tab displays the end-to-end latency of each flow, between the source and the unit, when both are locked to PTP. Any latency represents the time delay between the point at which a packet is created at the source and the point at which it is received. The *latency period* includes the length of time it takes to send the packet and the time taken by the packet to travel across the network. The unit calculates the latency by comparing the timestamp in the RTP packet header with the hardware timestamp at the time of ingest.

This tab provides both a graphical display of latency in the horizontal timing meters and a tabular display of the actual corresponding mean values in the right-hand Mean column. In the scalar view, the white arrows indicate the current latency, offset from PTP, and the black arrows show the historical maximum and minimum values. The actual mean values are shown in the Mean column to the right.

For information on the calculations used in ST 2110 mode, see the section ["Advanced Media Timing Measurement \(IP 2110 Mode\)" on page 12-13](#).

This tab aims to show the relationship between the video, audio and ancillary data flows and consequently, to indicate the amount of buffering required at the receiver to synchronize the flows.

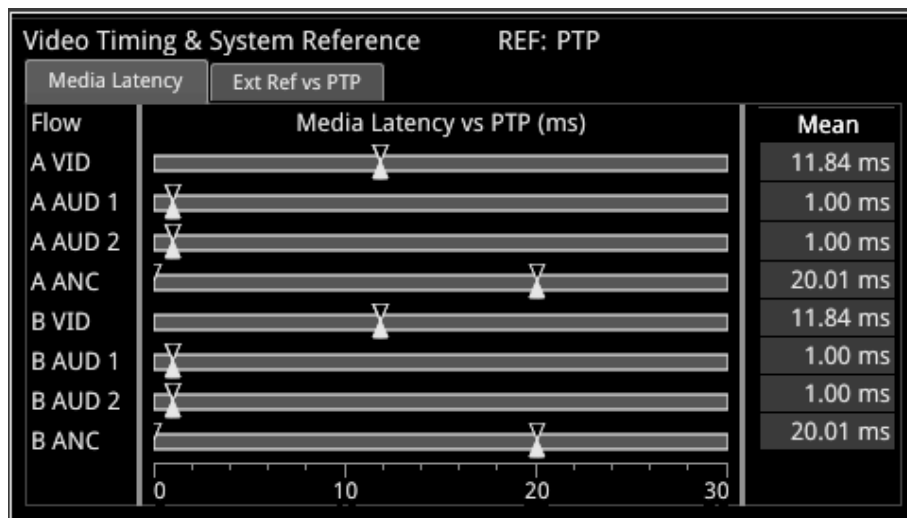

Figure 5-22: Media Latency Tab of the Video Timing & System Reference Instrument (IP 2110 Mode)

The **Media Latency** measure is the difference between the arrival time of a packet and the RTP timestamp of that packet, averaged over 1 second and is calculated as follows:

$$\text{Latency} = \text{TPA}_0 - \text{RTP}_{\text{Timestamp}} \text{ (averaged over 1 second)}$$

Where:

- TPA_0 is the arrival PTP time of a media packet as measured by the unit
- $RTP_{Timestamp}$ is the timestamp within the received packet created by the source.

For Video and ANC flows, the RTP timestamp is constant for the entire Frame, so the latency is only measured when the RTP timestamp changes. This occurs on the first packet of a frame for a progressive flow, or field for an interlaced flow, with the results averaged over 1 second.

For Audio flows, as the RTP timestamp increments with each audio packet the latency is measured for every packet with the results averaged over 1 second.

To see more detail about the media latency, you can zoom in on a specific area of interest by clicking anywhere on a timing meter of interest, which changes the scale to match the values of the specific flow. For example, when zooming into a video flow, the scale changes from milliseconds (ms) to microseconds (μ s). Click the meter again to zoom out and return to the overview. You can also switch between overview and zoom for individual flow meters by selecting the specific meter from the instrument submenu. See the Instrument options table below.

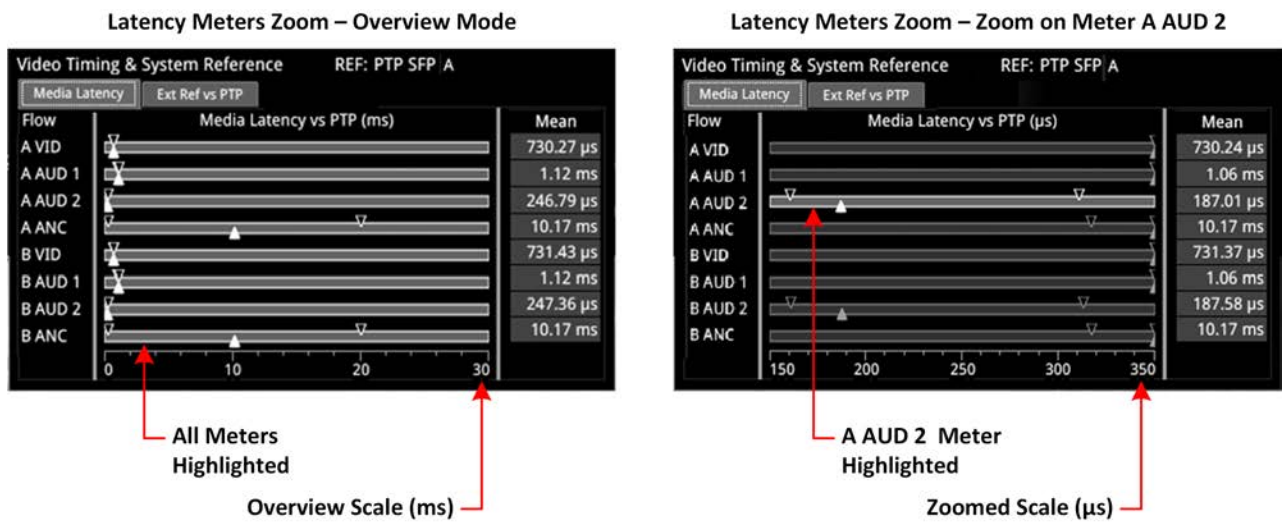

Figure 5-23: Media Latency Tab of the Video Timing & System Reference Instrument (IP 2110 Mode)

Instrument Menu Options

The following table lists the options that apply to the Media Latency tab and are available with a standard core license in the **Video Timing & System Reference** Instrument submenu in IP ST 2110 Mode:

Table 5-16 : Video Timing & System Reference Menu Options (2110 Mode)

Item	Options	Description
Ext Ref vs PTP Tab Options		
System Reference	PTP External Reference	System reference locking controls define the reference to which the Qx and any signal it generates is locked. In IP 2110 mode, make sure that the system reference is stably locked to the same PTP source as the sending device. System reference lock status information is displayed in the upper-right corner of the instrument, and any error in the health state of the reference is displayed in red.
Reference Timing Meter Range	+/- 0.1 line, +/- 0.5 line, +/- 0.5 frame	Adjusts the displayed range of the reference timing

Item	Options	Description
		meter in the upper section of the Instrument to display readings at frame scale, or to zoom in to a fraction of a line.
Media Latency Tab Options		
Latency Meters Zoom	Overview, A VID, A AUD 1, A AUD 2, A ANC, B VID, B AUD 1, B AUD 2, B ANC	Select a specific timing meter to switch between overview and zoomed-in view.
Anchor time scale start in Overview mode	Zero (0) or less, Any value	Set the start point of the timescale when in Overview.
Clear Min, Max values	N/A	Set the historical minimum and maximum values back to zero.

AES IO Config (IP Modes)



Overview

The unit provides powerful and flexible functionality for handling AES (Audio Engineering Society) input and output signals when present on pins 1 - 4 of the rear panel 26-way D-type connector. See the section ["Technical Specifications" on page 1](#) for more information on the connector pinouts. You can use a D-type to BNC converter to access the AES I/Os.

The **AES IO Config** Instrument provides a configurable gateway to the AES IO signals for IP ST 2022-6 and ST 2110. You can configure the AES IO so that an audio pair from the IP 2022-6 or 2110-30/31 input is routed to the four AES3 output interfaces. Encoded audio, such as Dolby E™, AC-3, or E-AC3, can be decoded by an external third-party decoder for monitoring purposes.

The **AES IO Config** Instrument provides an interface to configure the AES I/Os as follows :

- Up to four AES signals (a combination of inputs and/or outputs) can be handled at the same time
- SDI Input to AES Output audio conversion is available for both PCM and Dolby encoded audio (using the **Transmit - Analyzer**)
- Route AES Input signals to other AES outputs to provide a single loop output or up to three copy outputs (using **Transmit - Passthrough**).

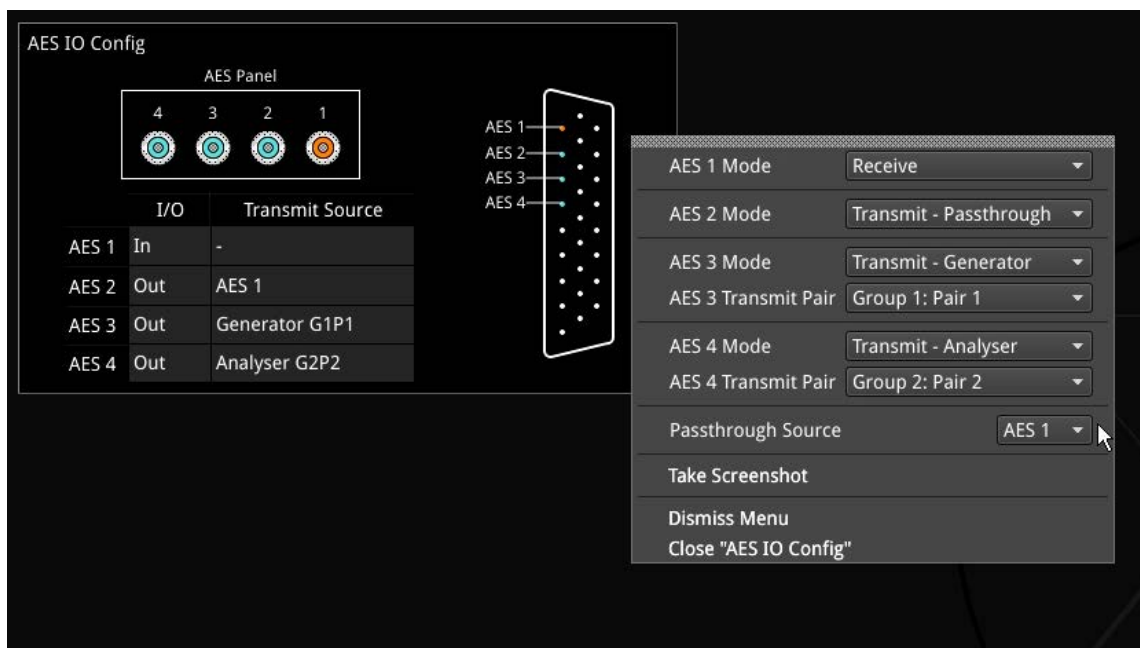

Figure 5-24: AES IO Config Instrument and Options Menu

The instrument provides a graphical display of the 26-way D-type rear panel connector of the unit, and labels the AES pins (pins 1 - 4). The AES Panel graphic shows the AES I/O BNCs in any AES breakout board connected to the rear panel D-type connector.

In both graphics, an active AES I/O is displayed in the Analyzer color when configured as an AES Input (in Receive mode) or in the Generator color when configured as an AES Output (in Transmit mode).

Below the AES Panel graphic, a table lists the status of each AES I/O. For AES Outputs the table also shows the transmit mode source. Any issues in the audio transmit source are highlighted in the table text as follows:

- Red: Configuration error
- Yellow: Audio source not present

Hover the mouse over the error text to display a tooltip describing how to resolve the issue.

Instrument Menu Options

Configure the AES I/Os in the instrument submenu as follows:

Each AES I/O can be set as an input (receive), or output (transmit):

- Off: AES I/O is switched off
- Receive: I/O is set to AES Input
- Transmit - Generator: I/O is set to AES Output

The output audio signal source is the unit's audio generator (See the Audio tab of the **Generator – Configuration** instrument.)

- Transmit - Analyzer: I/O is set to AES Output

The output audio signal comes from Image/Sub-image 1 of the analyzer input (SDI or IP 2022-6)

- Transmit - Passthrough: I/O is set to AES Output

The output audio signal is routed from the chosen AES input Passthrough Source

- AES 1/2/3/4 Mode > [Off, Receive, Transmit - Analyzer, Transmit - Generator, Transmit - Passthrough]
- AES 1/2/3/4 Mode > Transmit - Analyzer/Generator > AES 1/2/3/4 Transmit Pair > [Group 1: Pair 1, Group 1: Pair 2, Group 2: Pair 1, Group 2: Pair 2, Group 3: Pair 1, Group 3: Pair 2, Group 4: Pair 1, Group 4: Pair 2, Group 5: Pair 1, Group 5: Pair 2, Group 6: Pair 1, Group 6: Pair 2, Group 7: Pair 1, Group 7: Pair 2, Group 8: Pair 1, Group 8: Pair 2]
- Passthrough Source > [AES 1, AES 2, AES 3, AES 4]

Signal Generation Instruments

Note: Requires the **PHQXO-GEN** License.

This chapter describes the unit's signal generator Instruments and includes the following sections:

- [Generator Video](#)
- [Audio Generator](#)
- [Generator - Status](#)
- [IP Transmit \(SFP B\) \(IP 2022-6 Mode Only\)](#)



Requires Option(s):	PHQXO-GEN
---------------------	-----------

Overview

The **Generator - Configuration** instrument is available in SDI and ST 2022-6 modes of operation. UHD formats are supported with the PHQXO-UHD option in SDI mode. The generator instrument has two tabs: one to select the generator video standard and test pattern, and one for audio generation. In SDI Stress Toolset Mode, the Generate - Video submenu includes advanced generation tools which form part of the optional Advanced SDI Stress Toolset [PHQXO-SDI-STRESS].

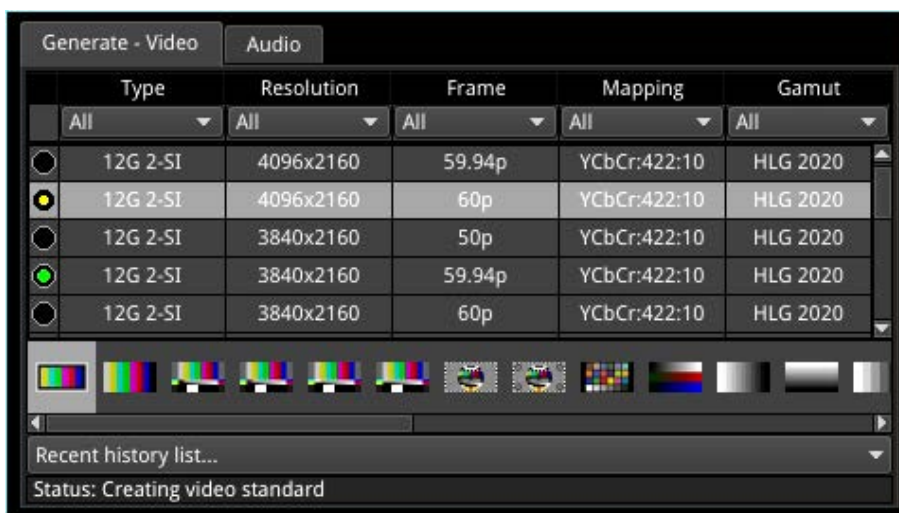

Figure 6-1: Generate - Video Instrument

With a test pattern selected, click on your chosen video standard to generate it. A traffic light indicator will turn yellow to show that generation is in progress. The light will turn green once the video standard has been successfully generated.

Note: The test pattern may take a few seconds to generate.

The unit provides video standard generation for a wide range of SDI rates, resolutions, frame rates, image mappings color gamuts, and transfer curves, dependent on licenses and boot mode.

To simplify selection, the generator standards list may be filtered using dropdown menus for the following parameters:

- Type > [All, 12G 2-SI, QL 3G A 2-SI, QL 3G A SqDv, QL 3G B 2-SI, QL 3G B SqDv, DL 6G 2-SI, 6G 2-SI, QL 1.5G SqDv, 3G A, 3G B, 1.5G]
- Resolution > [All, 1280x720, 1920x1080, 2048x1080, 3840x2160, 4096x2160]
- Frame > [All, 23.98p, 24p, 25p, 29.97p, 30p, 47.95p, 48p, 50i, 50p, 59.94i, 59.94p, 60i, 60p]
- Mapping > [All, YCbCr:422:10, YCbCr:422:12, YCbCrA:4224:12, YCbCr:444:10, YCbCr:444:12, YCbCrA:4444:10, RGB:444:10, RGB:444:12, RGBA:4444:10]
- Gamut > [All, 709, 2020, HLG 2020, PQ 2020, S-Log3 2020]

The Recent history list... provides a list of the most recently generated video standard and test pattern combinations. These can be quickly selected and regenerated from this dropdown list.

To clear the recent history, right-click to open the Options menu and select:

- Clear recent history list

The **Status** bar provides information on video generation progress.

Right-click anywhere in the **Generate - Video** window to display the configuration submenu.

Test Patterns

The list of available test patterns for a selected video standard is displayed at the bottom or in the right hand column of the **Generate - Video** window. These patterns include:

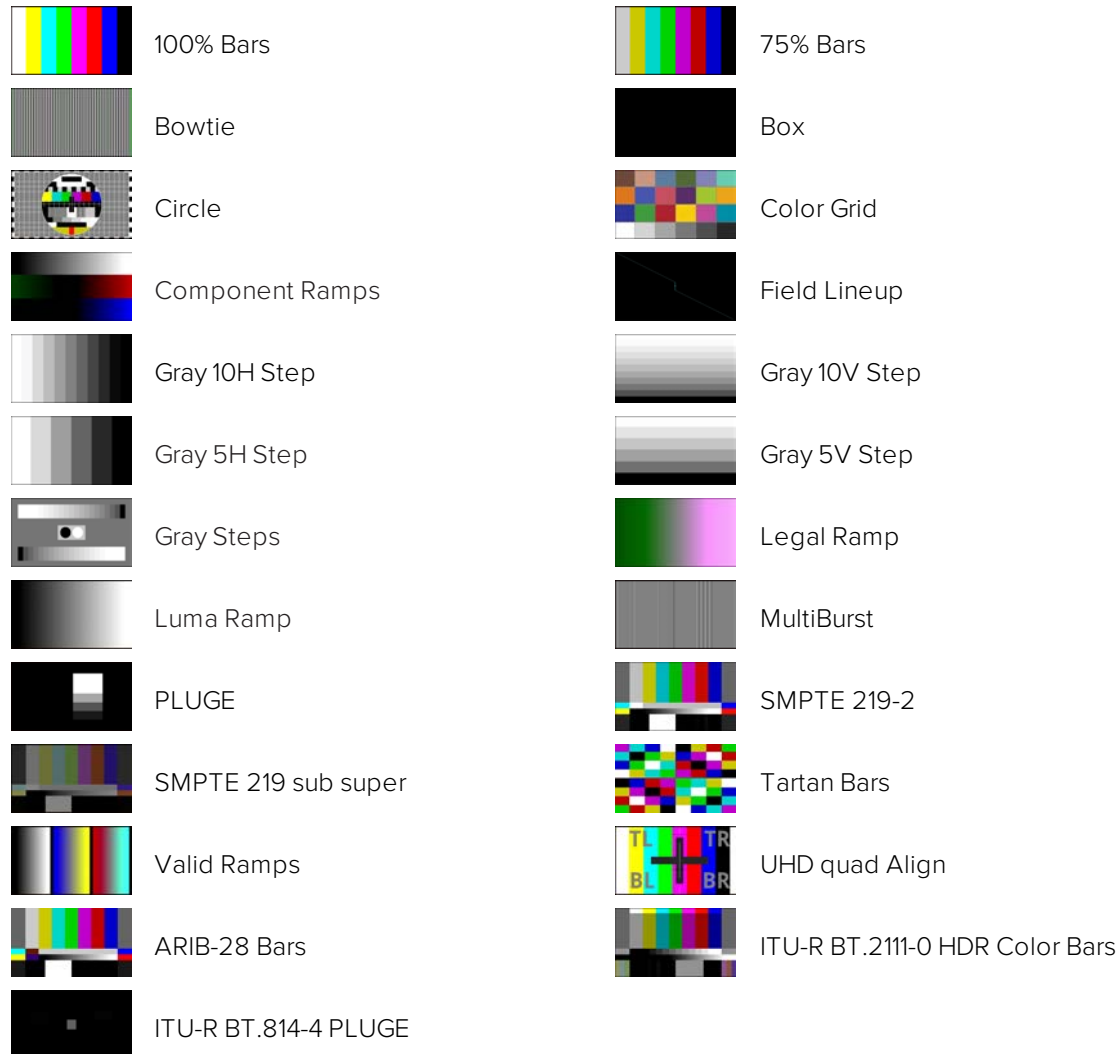

Figure 6-2: Available Test Patterns

Both S-Log3 and SR Live [S-Log3(HDR Live)] test pattern variants are available.

For moving test pattern provision, a bouncing box can be overlaid on top of any Generator test pattern

From the Options menu, select:

- Bouncing box > [Enabled, Disabled]

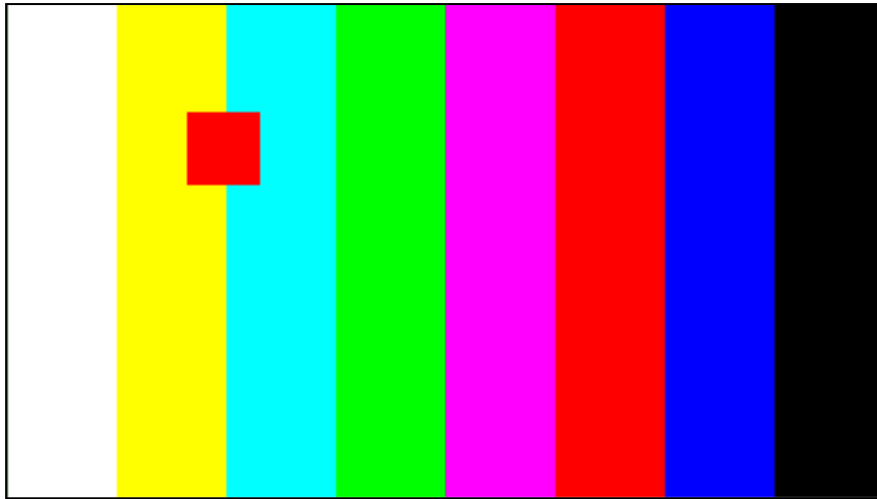

Figure 6-3: Bouncing Box Test Pattern Enabled

User Test Patterns and Images

Users can upload test images to the unit if required. These user test files must be in the Tagged Image File Format (TIFF) and of the exact pixel resolution of the video standard of intended use. The specifications for user test files are detailed below:

Table 6-1: Required Format of User Test Pattern Images

Format	Type	Extension	Pixel Resolutions	Bit Depth	Pixel Order
TIFF	Native (Files converted to TIFF from other formats are not supported)	.tif	1280 x 720 1920 x 1080 2048 x 1080 3840 x 2160 4096 x 2160	16 per RGB Component, 48 per Pixel	Interleaved

If you have direct access to the unit, you can upload user test files using the USB File Manager, see the section ["Managing Files with the USB File Manager" on page 3-19](#) for details. If you have only remote access to the unit, use SFTP to upload test files as described in the section ["Remote Connection to the Unit" on page 3-23](#)

Upload user test files to the **transfer/userTestPatterns** directory and then restart the unit. User test images will then be available in the **Generate - Video** tab of **Generator - Configuration** together with all other test patterns.

Generator Copy and SDI Out Configuration

The **Generator Copy** option in the submenu allows you to enable copying of the Generator SDI signal between the SDI outputs on BNC connectors A, B, C and D, depending on whether the input is single, dual or quad. For example, with a single input you can have three copies, two copies with dual input and no copies with quad input.

You can enable or disable copying of the Generator signal as follows:

- Generator Copy > [Disabled (default), Enabled]

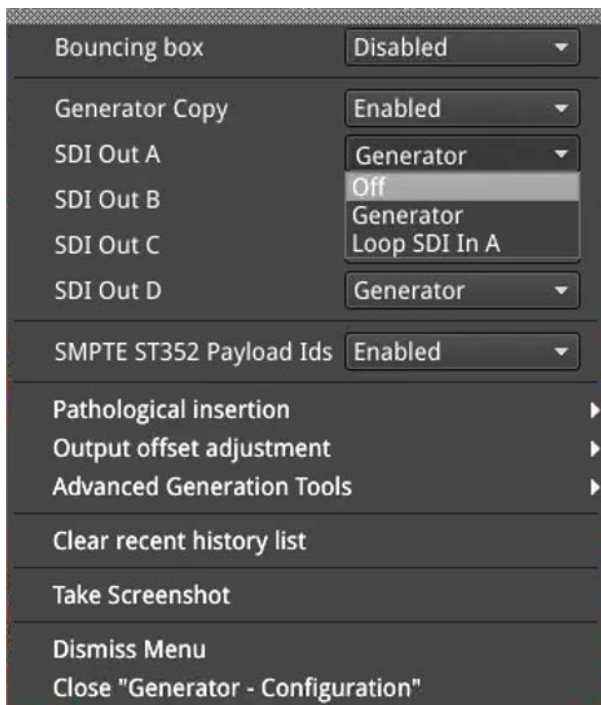

Figure 6-3: Generator Copy Options

In addition, you can configure each SDI Out connector (A, B, C or D) individually either to use the Loop SDI in A signal, the Generator signal or switch off the output as follows:

- SDI Out A > [Off (default), Generator, Loop SDI In A]
- SDI Out B > [Off (default), Generator, Loop SDI In B]
- SDI Out C > [Off (default), Generator, Loop SDI In C]
- SDI Out D > [Off (default), Generator, Loop SDI In D]

Hover over the unselected dropdown menu to display a tooltip informing you of the current configuration of the connector. The tooltips identify both the Primary Generator and the Generator Copy or Copies as shown below:

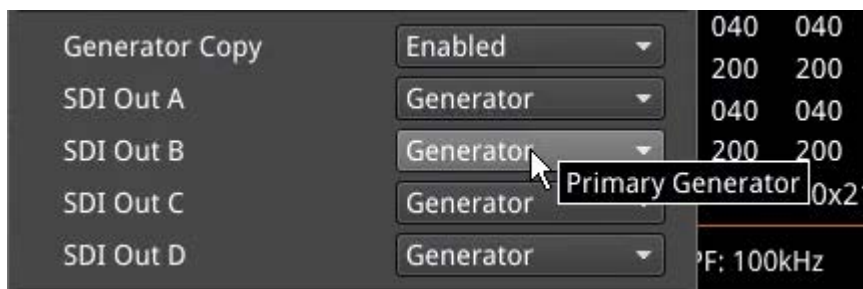

Figure 6-4: Tooltip Showing Current Configuration of Connector

When enabled in the **Generate -Video** window, you will also see the displayed status of the BNC connectors change in the **System IO** window to reflect the activity on the selected connectors.

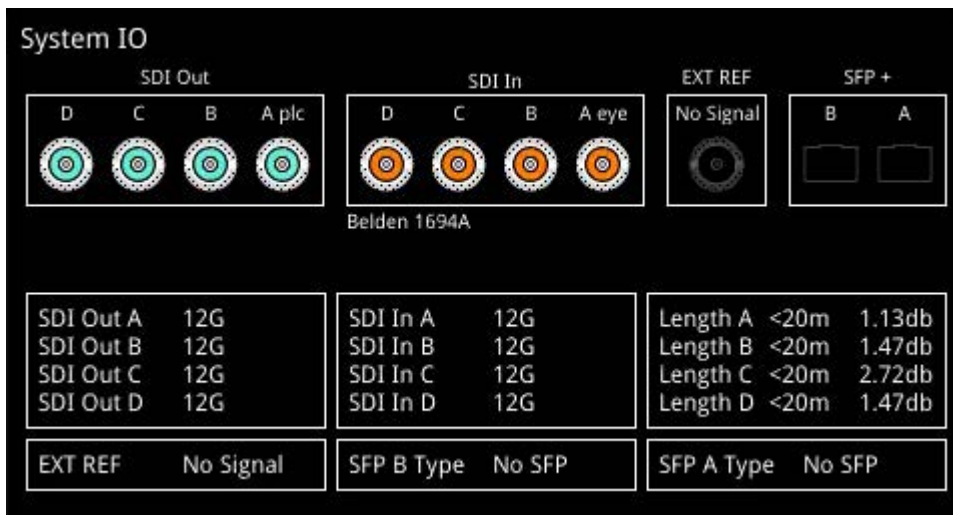

Figure 6-5: Color-coding of Active BNC Connectors in System IO Instrument

Insertion of SMPTE ST352 Payload IDs

The unit includes SMPTE ST352 Payload IDs in the generated standards by default. You can view the Hex IDs in Line 10 of the **Analyzer - Dataview** window. Alternatively select the Identifier **ST352 Payload ID** in the dropdown menu of the **Analyzer - Ancillary Inspector** window.

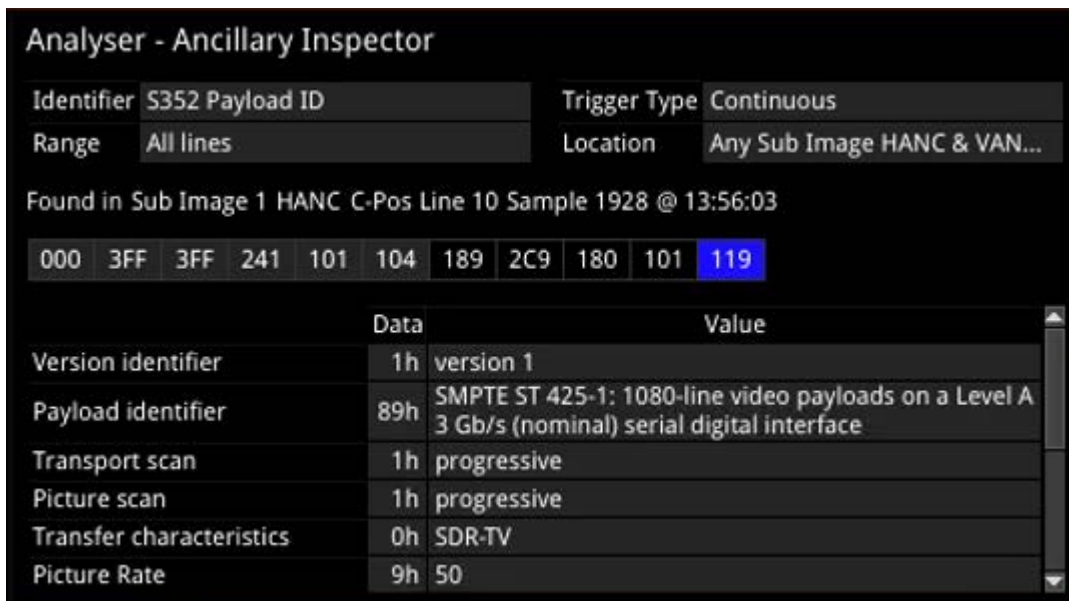

Figure 6-6: Analyzer - Ancillary Inspector Showing SMPTE ST352 Payload IDs

If you need to disable this feature (for example, for test purposes) you can do so by selecting **Disabled** in the Generator dropdown menu. When you select this option, the unit displays the following yellow warning message:

"Generated Video will not contain SMPTE ST352 Payload IDs".

If you generate your standard when Payload IDs are disabled, the unit displays a further popup warning dialog:

"Generating Standard does not conform to SMPTE Specifications. No ST352 Payload IDs inserted".

Click OK to close the dialog or wait for it to close automatically.

After re-enabling Payload IDs, always regenerate the standard to ensure that the Payload IDs are included.

Pathological Signal Insertion

Pathological Signal Insertion is a powerful feature used to test signal performance.

In addition to selecting a background test pattern, you can insert a pathological pattern as an overlay to the original test pattern. Enable pathological insertion from the right-click menu of the Generate - Video tab:

- Pathological insertion > Insertion > [Enabled, Disabled]

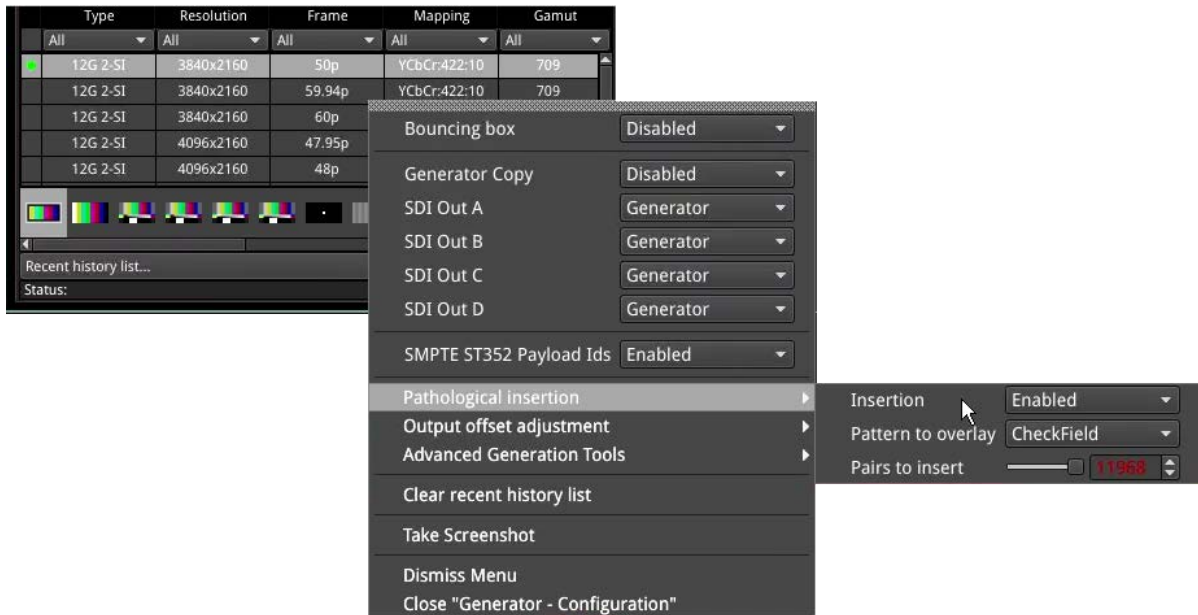

Figure 6-7: Menu Options for Pathological Signal Insertion

You can select a pathological patterns from the following:

- Pathological insertion > Pattern to overlay > [Eq, PLL, Clock (CLK), CheckField (Eq + PLL), CheckField + Clock (Eq + PLL + CLK)]

You can configure the amount of pathological pattern to verify the sensitivity of the SDI link to pathological conditions on the interface. This control limits at the line length of the selected format:

- Pathological insertion > Pairs to insert > [0 to 16384]

Note: Pathological signals are approved by SMPTE for use with HD and 3G Level A standards only. For 3G Level B, 6G and 12G-SDI interface formats, pathological signals can be used, but are not approved by SMPTE (as of January 2020). It is believed that inserting a full line of pathological signal in these non-approved standards is too stressful a test for the SDI interface. No physical damage will occur, but the interface may exhibit reduced operating performance in the form of bit errors.

Output Offset Adjustment (SDI Modes)

A signal can be generated with a fixed offset, relative to the system reference.

Offsets can be entered in temporal or spatial terms:

- Output offset adjustment > Offset Type > [Time, Lines And Pixels]

Select **Time** to display a drop-down field in which to set the timing offset in microseconds:

- Output offset adjustment > Offset Type > Time > Output Time Offset > [0.00, +/- 0.01, etc...]

Select **Lines And Pixels** to display drop-down fields in which to set the offset in coordinate terms:

- Output offset adjustment > Offset Type > Lines And Pixels > Output Line Offset > [0 to +/- (Total number of Lines for current standard minus one)]
- Output offset adjustment > Offset Type > Lines And Pixels > Pixel Offset > [0 to +/- (Total number of Pixels per Line for current standard minus one)]

You can remove the Generator Offset by selecting the following:

- Output offset adjustment > Clear offsets



Requires Option(s):	PHQXO-GEN
----------------------------	------------------

32-channel audio generation is available in the **Audio** tab of the **Generator - Configuration** instrument. In the instrument submenu Audio Macros are provided for quick configuration, along with the ability to enable and disable audio in individual sub images.

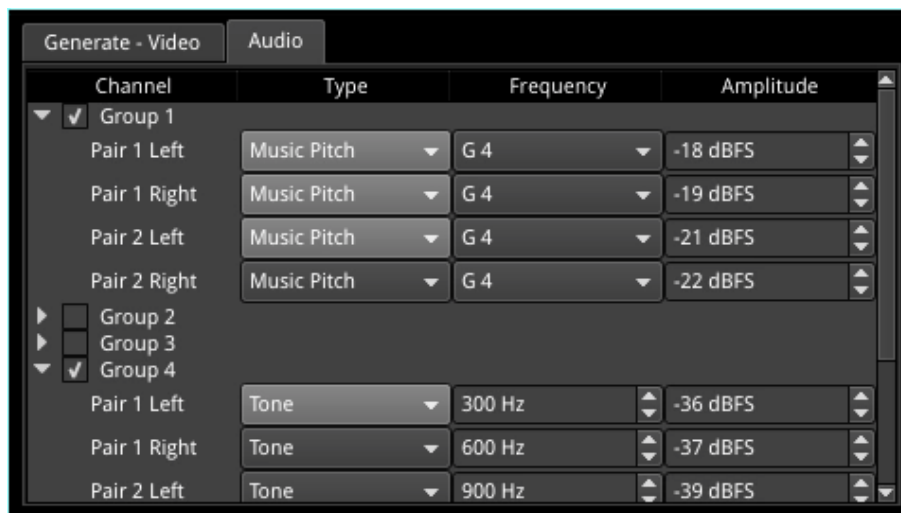

Figure 6-8: Generator Configuration - Audio Tab

Depending on the generated video standard, up to eight audio groups (32 channels) are available.

In the Audio tab, audio Groups can be switched on and off as required using the checkboxes. Selecting the arrow to the left of a group reveals all the channels in that group. Clicking on the arrow again hides these audio pairs.

Each channel can be configured by frequency and amplitude. Frequency can be set by music pitch or exact tone frequency (Hz):

- Type > [Tone, Music Pitch]
- Type > Tone > [0 Hz to 10000 Hz]
- Type > Music Pitch > [C 3, C #D b 3, D 3, D #E b 3, E 3, F 3, F #G b 3, G 3, G #A b 3, A 3, A #B b 3, B 3, C 4, C #D b 4, D 4, D #E b 4, E 4, F 4, F #G b 4, G 4, G #A b 4, A 4, A #B b 4, B 4, C 5, C #D b 5, D 5, D #E b 5, E 5, F 5, F #G b 5, G 5, G #A b 5, A 5, A #B b 5, B 5, C 6, C #D b 6, D 6, D #E b 6, E 6, F 6, F #G b 6, G 6, G #A b 6, A 6, A #B b 6, B 6, C 7]

Amplitude levels can be adjusted in decibels relative to full scale (dBFS):

- Amplitude > [-144 dBFS to 0 dBFS]

For fast configuration, the submenu provides *Audio Macros*. The Macro list contains pre-configured audio channel setups which can be used or adapted for use:

- Audio Macros > Macro list > [Select..., Fixed Tone Ramp Levels, Fixed Tone Fixed Level, Musical Pitch Ramp Levels, Musical Pitch Fixed Levels]

When tone is fixed (i.e. Fixed Tone Ramp Level, Fixed Tone Fixed Level), or when Select... is chosen, to adjust the frequency select:

- Audio Macros > Fixed frequency > [C 3, C #D b 3, D 3, D #E b 3, E 3, F 3, F #G b 3, G 3, G #A b 3, A 3, A #B b 3, B 3, C 4, C #D b 4, D 4, D #E b 4, E 4, F 4, F #G b 4, G 4, G #A b 4, A 4,

A#B ♭ 4, B 4, C 5, C#D ♭ 5, D 5, D#E ♭ 5, E 5, F 5, F#G ♭ 5, G 5, G#A ♭ 5, A 5, A#B ♭ 5, B 5, C 6, C#D ♭ 6, D 6, D#E ♭ 6, E 6, F 6, F#G ♭ 6, G 6, G#A ♭ 6, A 6, A#B ♭ 6, B 6, C 7]

When levels are fixed (i.e., Fixed Tone Fixed Level, Musical Pitch Fixed Levels), to adjust amplitude select:

- Audio Macros > Fixed Amplitude > [-144 dBFS to 0 dBFS]

The Macros are applied across all audio groups.

Audio can be enabled or disabled by Sub image:

- Sub Image Enable > Sub image 1 / 2 / 3 / 4 > [Enabled, Disabled]



Requires Option(s):	PHQXO-GEN
---------------------	-----------

Overview

The **Generator - Status** window confirms the generated Video Standard and Test Pattern details. The window shows the generator pattern selected, or PRBS signal selected (available in the optional SDI Stress mode), and confirms the BNC output (SDI Modes only) or SFP output presence, and Sub Image/Full Image mapping information. Audio Presence and Sub Image information is also displayed, along with Video Reference, Output offset adjustment, and Jitter insertion (optional SDI Stress mode) details. This window provides status information only; there are no user settings to configure.

Generator - Status				
Video standard	4096x2160p47.95 YCbCr:422:10 QL 3G A SQ HLG Rec.2020			
Test pattern	Circle with bouncing box			
Pathological	793/2048 pairs (5.34µs) of "CheckField" inserted			
	Output	Mapping	Pathological PLL/s	Pathological Eq/s
SDI Out A	3G	Sub Image 1	41	70
SDI Out B	3G	Sub Image 2	27	48
SDI Out C	3G	Sub Image 3	61	55
SDI Out D	3G	Sub Image 4	52	42
Audio Presence	1: PPPP 2: ---- 3: PPPP 4: PPPP 5: ---- 6: ---- 7: ---- 8: ----			
Audio Sub Images	Enabled: 1, 2, 4			
Reference	Free Run, stable			
Offset	0.07 µs			
Jitter	Sine: 199.5Hz 6.78UI			

Figure 6-9: Generator - Status Instrument

When you generate a pathological overlay in **Generator – Configuration**, the unit detects this for all SDI outputs. The Pathological PLL(s) and Eq(s) will then display the number of pathological events generated per second. As one pathological event is created per line this also indicates the number of lines per second on which pathological conditions occur on the interface. The detection of a pathological condition is available as a GPI output from the unit for use in triggering an external analyzer device.

Note: Pathological Rate(s) counters are not displayed in PRBS Mode.

IP Transmit (SFP B) (ST 2022-6 Mode)



Requires Option(s):	PHQXO-IP-STND, PHQXO-GEN and PHQXO-IP-NGT
---------------------	---

Overview

The **IP Transmit (SFP B)** window is used to transmit the currently generated video standard signal as IP video packets.

You can use this tool to simulate IP video network packet jitter introduced under a variety of network conditions by adjusting the transmission distribution profile.

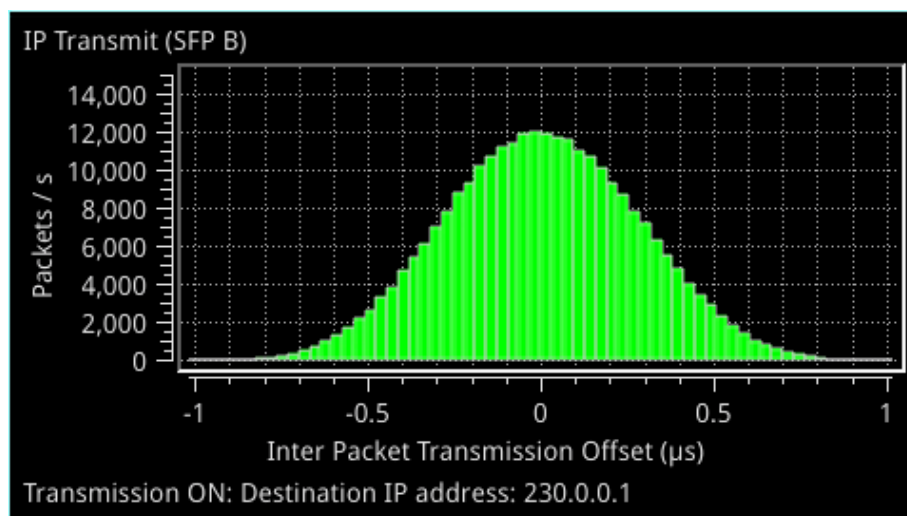

Figure 6-10: IP Transmit (SFP B) (IP ST 2022-6 Mode)

The histogram shows the interval timing distribution of the packets being generated (each second) - that is: the number of packets being generated each second, against the deviation of each packet interval from the expected interval time. Transmission status information and prompts are also displayed at the bottom of the window. Hover over this status information to display a tooltip detailing the Current Transmit Parameters, see the section ["Network Settings" on the facing page](#) for more information.

Right-click in the window to display the IP Transmit submenu:

Packet transmission can be switched on and off:

- Transmit > [On, Off]

The type of distribution profile can be selected, and the range of transmission packet intervals can be adjusted. The adjustments are displayed in real-time, in the transmission histogram.

- Distribution Range > [slider +/- 0 to 492 clks]
- Distribution > [Uniform, Gaussian]

The submenu also provides the option to plot the number of transmitted packets on the vertical axis, in either linear or logarithmic scale:

- Y-Axis Scale > [Linear, Log10]

Network Settings

IP, UDP, MAC, and SSRC network settings for packet transmission are set in the submenu, and can be entered by USB keyboard when Transmit is Off.

Transmission can be either multicast or unicast. The multicast group destination IP address, or the IP address of the receive device (in the case of unicast) should be set as the destination IP address; as required:

- Dst IP Addr > [set IP address]

The destination MAC address should be set as required, to Automatic for multicast, or SFP A for unicast transmission to the same unit. For unicast transmission to another device, set to Manual, and then enter below, the MAC address of the receive device (in the case of a direct connection) or the first switching device in the path of the transmitting unit (in the case of an indirect connection to the receive device).

- Dst MAC Addr > [Automatic, Manual, SFP A]

UDP parameters:

- Src UDP Port > [set UDP port number as required]
- Dst UDP Port > [set UDP port number as required]

A Synchronization source identifier (SSRC) can be set for Real-time Transport Protocol (RTP) stream subscription if required:

- SSRC > [set ID if required]

Once required network settings have been entered, switch on Transmit to start transmission.

Note: Ensure that you are generating a test signal for transmission in the **Generator - Video Standard** Instrument.

Standard Analysis Instruments

This chapter describes the standard analytical instruments provided with the unit and includes the following sections:

- [Analyzer - Video Standard](#)
- [Stats - SDI in A, B, C, D](#)
- [Stats - IP Receive \(SFP A\)](#)

Analyzer - Video Standard (SDI and ST 2022-6 Modes)



Overview

The **Analyzer - Video Standard** instrument (SDI & 2022-6) displays the payloads of the video standard being analyzed as described by ST 352 packets. It lists the payloads on SDI (SDI Modes) / 2022-6 SFP (IP 2022-6 Mode) input signals. The lower pane summarizes the video standard and any analyzer overrides already set.

Input	Payload Identifiers (SMPTE ST 352)
SDI A (3G)	Y-pos :4096x2160p47.95 YCbCr:422:10 QL 3G A 2-SI Link1 Rec.709 C-pos :4096x2160p47.95 YCbCr:422:10 QL 3G A 2-SI Link1 Rec.709
SDI B (3G)	Y-pos :4096x2160p47.95 YCbCr:422:10 QL 3G A 2-SI Link2 Rec.709 C-pos :4096x2160p47.95 YCbCr:422:10 QL 3G A 2-SI Link2 Rec.709
SDI C (3G)	Y-pos :4096x2160p47.95 YCbCr:422:10 QL 3G A 2-SI Link3 Rec.709 C-pos :4096x2160p47.95 YCbCr:422:10 QL 3G A 2-SI Link3 Rec.709
SDI D (3G)	Y-pos :4096x2160p47.95 YCbCr:422:10 QL 3G A 2-SI Link4 Rec.709 C-pos :4096x2160p47.95 YCbCr:422:10 QL 3G A 2-SI Link4 Rec.709
Standard: 4096x2160p47.95 YCbCr:422:10 QL 3G A 2-SI Rec.709 Overrides: HLG Rec.2020	

Figure 7-1: Analyzer - Video Standard Instrument

Unstable payloads, or those with damaged or missing ST 352 packets, are listed in the **Analyzer - Video Standard** window. Payload identifier errors are displayed in red font with warnings in yellow.

Instrument Menu Options

Ignore Payload Identifier Packets (ST 352)

In situations where the accuracy of incoming ST-352 packets cannot be relied upon, the instrument can be forced to ignore the ST-352 packets, and image parameter overrides can be set by the user. To ignore incoming ST-352 packets enable **Ignore Payload Identifier Packets (ST-352)** in the submenu.

- Ignore Payload Identifier Packets (ST 352) > [Enabled, Disabled]

Payloads with ignored ST 352 packets are indicated in the **Analyzer - Video Standard** window.

Sub Image Pixel Mapping Format Override

Where sub image format signals are delivered without ST-352 packet payload IDs or with mislabeled sub image mapping information (for example, if a two sample interleave (2-SI) signal content is delivered incorrectly as square division (SQ)) you need to be able to override the erroneous mapping to display the content correctly.

- Enable Sub Image Pixel Mapping Format Override > [Enabled, Disabled]
- Sub Image Pixel Mapping Format Override > [2 Sampl...erleave, Square Division]

Stats - SDI In A, B, C, D (SDI Modes)



Overview

The **Stats - SDI In A, B, C and D** window provides information to verify the format of the signals being analyzed, and input cable length information. A video signal may be comprised of up to four separate SDI signals each providing a sub-image.

Stats - SDI In A		12G Signal			
Data Rate: 11.880000 GHz		Clock Divisor: 1.000		Cable Length: 21m	
	Sub Image 1	Sub Image 2	Sub Image 3	Sub Image 4	
Counters Stable	true	true	true	true	
Active Samples Per Line	2048	2048	2048	2048	
Active Lines Per Field	1080	1080	1080	1080	
Total Samples Per Line	2640	2640	2640	2640	
Total Lines Frame/Field1	1125	1125	1125	1125	
Total Lines Field2	progressive	progressive	progressive	progressive	
Payload ID Y-Pos	CE C9 40 01	CE C9 40 01	CE C9 40 01	CE C9 40 01	
Payload ID C-Pos	CE C9 40 01	CE C9 40 01	CE C9 40 01	CE C9 40 01	

Figure 7-2: Stats - SDI In A: Displaying Data from Single 12G Input on Input A

Stats - SDI In A		3G Signal		Stats - SDI In B		3G Signal	
Data Rate: 2.967033 GHz		Clock Divisor: 1.001		Data Rate: 2.967033 GHz		Clock Divisor: 1.001	
		Cable Length: 1m				Cable Length: 0m	
	Sub Image 1				Sub Image 1		
Counters Stable	true			Counters Stable	true		
Active Samples Per Line	4096 (B mux)			Active Samples Per Line	4096 (B mux)		
Active Lines Per Field	540			Active Lines Per Field	540		
Total Samples Per Line	5500 (B mux)			Total Samples Per Line	5500 (B mux)		
Total Lines Frame/Field1	563			Total Lines Frame/Field1	563		
Total Lines Field2	562			Total Lines Field2	562		
Payload ID Y-Pos LinkA	8A 44 40 01			Payload ID Y-Pos LinkA	8A 44 40 01		
Payload ID C-Pos LinkA	unnecessary			Payload ID C-Pos LinkA	unnecessary		
Payload ID Y-Pos LinkB	8A 44 40 41			Payload ID Y-Pos LinkB	8A 44 40 41		
Payload ID C-Pos LinkB	unnecessary			Payload ID C-Pos LinkB	unnecessary		
Stats - SDI In C		3G Signal		Stats - SDI In D		3G Signal	
Data Rate: 2.967033 GHz		Clock Divisor: 1.001		Data Rate: 2.967033 GHz		Clock Divisor: 1.001	
		Cable Length: 1m				Cable Length: 1m	
	Sub Image 1				Sub Image 1		
Counters Stable	true			Counters Stable	true		
Active Samples Per Line	4096 (B mux)			Active Samples Per Line	4096 (B mux)		
Active Lines Per Field	540			Active Lines Per Field	540		
Total Samples Per Line	5500 (B mux)			Total Samples Per Line	5500 (B mux)		
Total Lines Frame/Field1	563			Total Lines Frame/Field1	563		
Total Lines Field2	562			Total Lines Field2	562		
Payload ID Y-Pos LinkA	8A 44 40 01			Payload ID Y-Pos LinkA	8A 44 40 01		
Payload ID C-Pos LinkA	unnecessary			Payload ID C-Pos LinkA	unnecessary		
Payload ID Y-Pos LinkB	8A 44 40 41			Payload ID Y-Pos LinkB	8A 44 40 41		
Payload ID C-Pos LinkB	unnecessary			Payload ID C-Pos LinkB	unnecessary		

Figure 7-3: Stats - SDI In A: Displaying Data from Quad 3G Input in Four Windows

Stats - IP Receive (SFP A) (ST 2022-6 Mode)



Requires Option(s):	PHQXO-IP-STND
---------------------	---------------

Overview

The **Stats - IP Receive (SFP A)** window provides information to verify the format of the signal being analyzed when working in ST 2022-6 mode.

Stats - IP Receive (SFP A) 3G Signal

Clock Divisor: 1.001

	Sub Image 1
Counters Stable	true
Active Samples Per Line	4096 (B mux)
Active Lines Per Field	540
Total Samples Per Line	4400 (B mux)
Total Lines Frame/Field1	563
Total Lines Field2	562
Payload ID Y-Pos LinkA	8A 5A C0 01
Payload ID C-Pos LinkA	unnecessary
Payload ID Y-Pos LinkB	8A 5A C0 41
Payload ID C-Pos LinkB	unnecessary

Figure 7-4: Stats - IP Receive (SFP A) Instrument

Network Analysis Instruments

This chapter describes Instruments for the analysis of the network quality and includes the following sections:

- [Analyzer - 2022-7 Status](#)
- [SFP \(A,B\) - Network Stats](#)

Analyzer - 2022-7 Status (IP ST 2110 Mode)



Requires Option(s):	PHQXO-IP-STND
---------------------	---------------

Overview

Transmitting each media stream across dual, fully-redundant networks or links enables receivers/decoders to use ST 2022-7 Seamless IP Protection Switching (SIPS). This provides perfect error-free transport even in the case of severe packet loss or link outages as long as one good packet arrives within a certain time window on either of the two network links. Depending on the receiver buffer size and desired maximum latency, an individual decoder will be designed to accommodate a specific maximum amount of *Skew* between the two flows.

The **Analyzer - 2022-7 Status** instrument provides an indication of the health of each ST 2022-7 flow pair and the time difference (Skew) between their incoming packets, depending on the selected receiver classification, as described in the instrument menu options table.

Negative Skew indicates that packets on SFP A interface have arrived first. Positive Skew indicates that packets on the SFP B interface have arrived first.



Figure 8-1: Analyzer - 2022-7 Status Instrument

Double-click the instrument to display all four flows in 1/4 display size as shown above. Double-click again to reduce to 1/16 display size, with a tab to display each flow. Each tab will change color to yellow or red to provide a quick indication of a warning or an error respectively.

Features include:

- Indication of the health of ST 2022-7 seamless protection
- Warning of ST 2022-7 flow-pair mismatch
- Warnings of errors on flows and errors on reconstructed output and error rates per second
- Relative measure of Path Differential (Skew) of flows on SFP B (Blue Network) relative to SFP A (Amber Network), with Class A, B, C, D markers.

Instrument Menu Options

The following table lists the options available in the Analyzer - 2022-7 Status instrument submenu:

Table 8-1: Analyzer - 2022-7 Status Options

Item	Options	Description
Receiver Classification	Class A Class B Class C Class D	Class A: Low-Skew ≤ 10 ms Class B: Moderate-Skew ≤ 50 ms Class C: High-Skew ≤ 450 ms for flows under 270 Mb/s and <150 ms for flows ≥ 270 Mb/s Class D: Ultra Low-Skew <150 μ s
Reset errors and running time	Instrument Control	Resets any errors that have occurred during the running period and sets the running time back to zero.

Note: Set the video frame rate correctly in the **Analyzer - 2110 Format Setup** instrument to ensure accurate video skew measurements.

SFP (A, B) - Network Stats



For IP ST 2022-6 SFP-A, Requires Option:	PHQXO-IP-STND
For IP ST 2022-6 SFP-B, Requires Option:	PHQXO-IP-STND
For IP ST 2110-20, Requires Option:	PHQXO-IP-STND

Overview

The **Network Stats** instrument displays transmission and reception traffic information, detailing the type and number of packets sent and received by an SFP. CRC errors are identified and packet sequence errors reported. Double-clicking the window expands it, to reveal additional packet information.

SFP A - Network Stats		
	Rx Cumulative	Tx Cumulative
Packets:	266454212	0
Good Packets:	266444039	0
Bytes:	385292784614	0
Bad FCS:	10173	N/A
Multicast:	266444039	0
Unicast:	0	0
Broadcast:	0	0
VLAN:	0	0

Figure 8-2: SFP A - Network Stats Instrument

Content Analysis Instruments

This chapter describes the Instruments used to analyze the quality of the video signal and includes the following sections:

- [Analyzer - Picture](#)
- [Analyzer - Waveform](#)
- [Analyzer - Vectorscope](#)
- [Analyzer - CRC Analysis](#)



Overview

The **Picture** view shows the generator pattern currently being analyzed by the unit. Double-click anywhere in the window to resize the view between:

- One sixteenth (1/16) of the screen
- One quarter (1/4) of the screen
- Full screen.

Some features of the Picture instrument are dynamically linked to the Dataview and Waveform Analyzer instruments to enable more precise analysis of the picture.

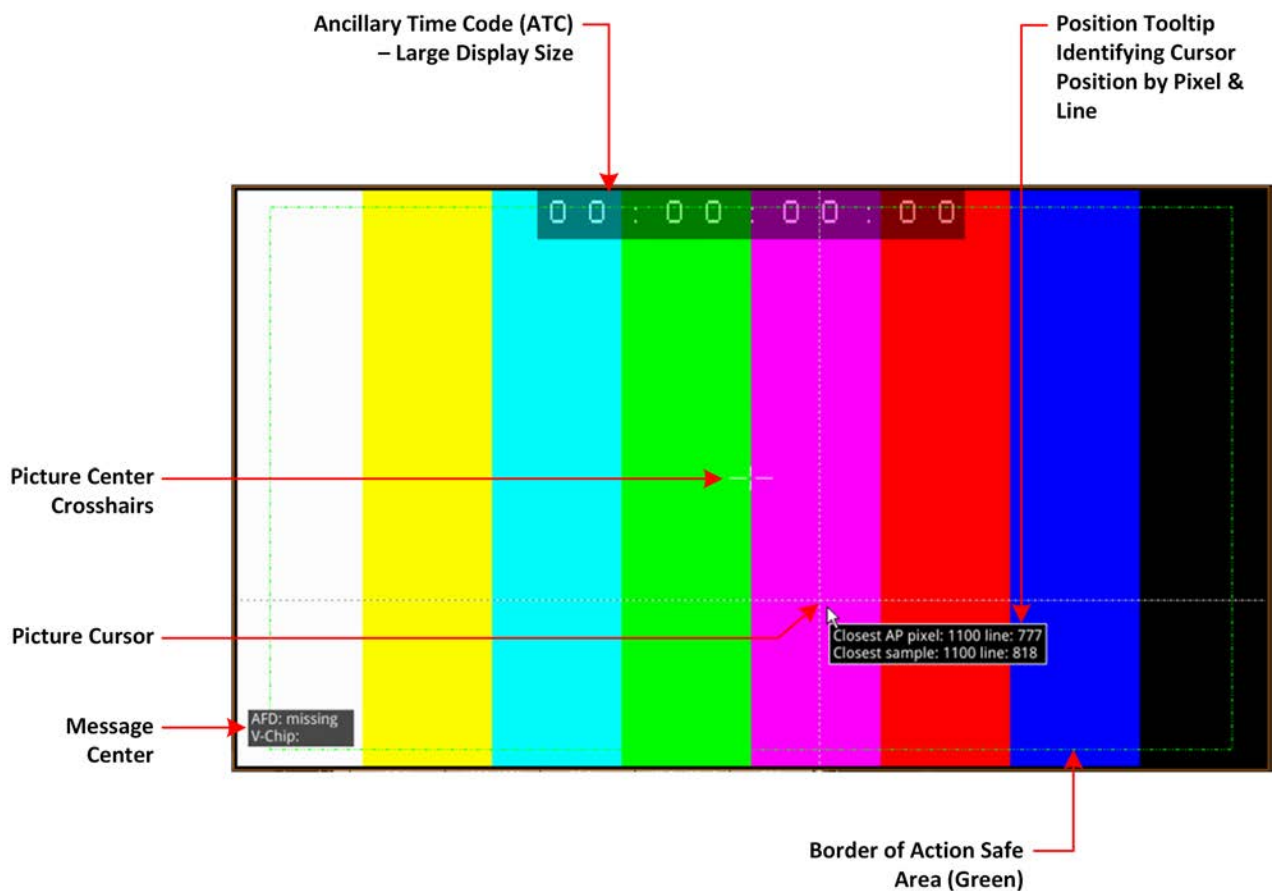

Figure 9-1: Components of the Analyzer - Picture Instrument

In addition to displaying the video picture, you can configure the Picture instrument to overlay various data elements, extracted from the ancillary data in the video signal, for quality control purposes, including:

- Closed Captions
- Ancillary Time Code (ATC)
- Picture Cursor and Position Tooltip
- Picture Safe Areas
- Picture Center Crosshairs

- Message Center displaying V-chip, AFD, Input Name, ST309 Date and SCTE104 data (depending on configuration)
- HDR False Color Overlay and Grayscale Mode (HDR Mode Only). See the section ["HDR Heatmap \(False Color Overlay\)" on page 15-6](#)

Instrument Menu Options

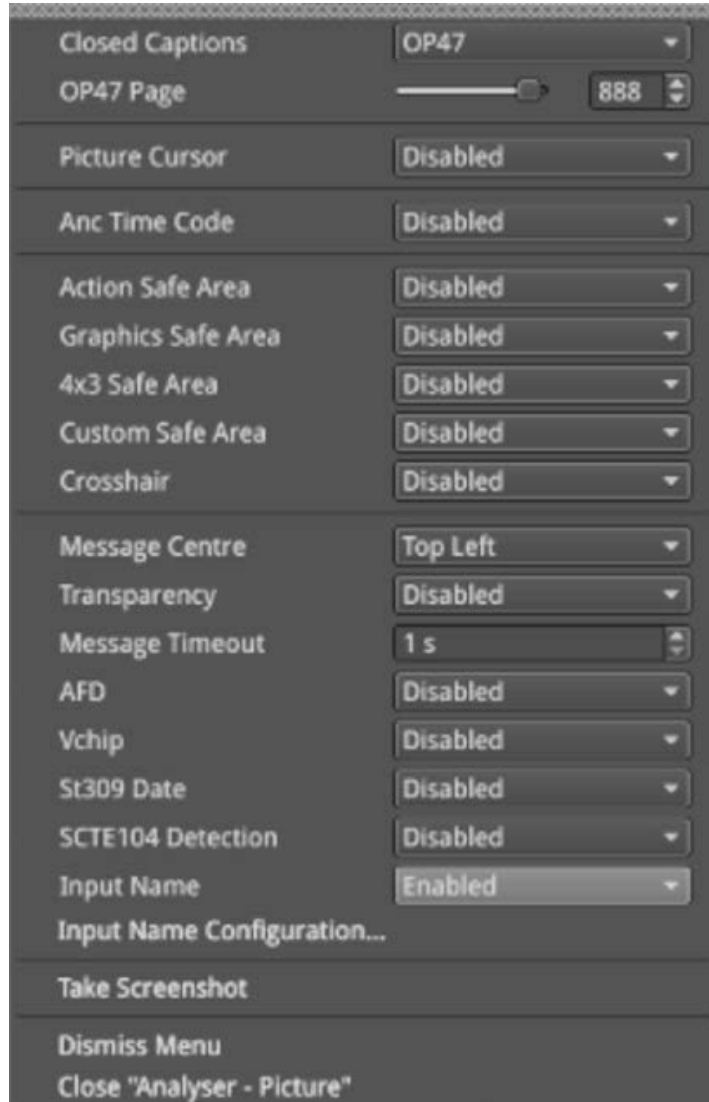

Figure 9-2: Analyzer - Picture Instrument Standard Options Menu

The following table lists the standard options available in the Analyzer - Picture Instrument submenu:

Table 9-1: Menu Options for the Analyzer - Picture Instrument

Item	Options	Description
Closed Captions	Disabled (Default)	The unit can detect closed captions carried in the ancillary data of a signal.
	OP47	Select this option to enable closed captions and display OP47 standard closed captions in the picture view. This displays an additional menu entry: OP47 Page.
	OP47 Page	Select the desired OP47 page containing the relevant closed captions, by using the slider or scrolling through page numbers in the range: 100 to 8ff.

Item	Options	Description
	608	Select this option to enable closed captions and display CEA 608 standard closed captions in the picture view for monitoring. This displays an additional menu entry enabling you to select the desired target field to contain the CEA 608 format closed captions.
	608 in 708	Select this option to enable closed captions and display 608 in 708 standard closed captions in the picture view for high definition (HD) video. This displays an additional menu entry enabling you to select the desired target field to contain the 708 format closed captions.
	608 Field	Select the desired field for the 608 captions, from either Field 1 or Field 2.
Picture Cursor	Disabled (Default)	When enabled, this feature is dynamically linked to both the Waveform and Dataview Analyzer instruments so that measurements from the selected picture position can be taken from these tools at the same time.
	Enabled	Allows you to select a specific line and pixel position in the picture. When you specify the line and pixel numbers, the unit positions a visible cross-hair at that position. You can change the location of the cross-hair by clicking at a different position in the Picture window. Line: Line one to Total number of Active Lines for the current standard. Pixel: Pixel zero to Total number of Active Pixels for the current standard minus one.
Ancillary Time Code (ATC) Display		
Ancillary Time Code	Disabled (Default) Enabled	Activates the display of the ATC panel.
Ancillary Time Code Size	Small Medium Large Auto	Increases or decreases the displayed size of the ATC panel in the picture window. The Auto option adjusts the size of the timecode panel automatically, depending on the displayed size of the instrument window. When the instrument window is at 1/16 screen size, the Auto option sets the timecode panel to small, at 1/4 screen size to medium and at full screen to large.
Ancillary Time Code Position	Bottom Middle Top	Adjusts the displayed position of the ATC panel on the vertical center-line of the window.
Ancillary Time Code Field	Disabled (Default) Enabled	Activates an optional final digit in the furthest-right position of the time code to display a field identification flag for either 25 Hz or 24/30 Hz.
Safe Area Generation		
Action Safe Area	Disabled (Default) Enabled	Activates display of 16:9 safe area border for actions as a green, dashed border.
Graphics Safe Area	Disabled (Default) Enabled	Activates display of 16:9 safe area for graphics as a red, dashed border.

Item	Options	Description
4x3 Safe Area	Disabled (Default) Enabled	Activates display of 4:3 safe area as a cyan, dotted border.
Custom Safe Area	Disabled (Default) Enabled	Activates display of a user-defined safe area as a white, dashed border.
Custom Height %	Enter percentage	Specifies the custom safe area height as a percentage of the full screen height, by adjusting the top and bottom screen margins.
Custom Width %	Enter percentage	Specifies the custom safe area width as a percentage of the full screen width, by adjusting the left and right screen margins.
Custom Height Offset %	Enter percentage	Specifies the custom safe area height offset as a percentage from the horizontal center line of the screen.
Custom Width Offset %	Enter percentage	Specifies the custom safe area width offset as a percentage from the from the vertical center line of the screen.
Crosshair	Disabled (Default) Enabled	Activates the display of a cross-hair to indicate the image center.
Message Center Display		
Message Center	Top Left Top Right Bottom Left Bottom Right	Defines the position of the Message Center panel in the Analyzer - Picture window by screen quadrant. The Message Center displays messages decapsulated from the ancillary data packets and includes SCTE 104 ID, AFD and V-Clip.
Transparency	Disabled (Default) Enabled	Activates a transparent background to the Message Center in the Picture display.
Message Timeout (secs)	1 to 10 seconds	Defines the length of time in seconds dynamic SCTE104 messages are displayed in the Message Center. SCTE104 messages are removed from the Message Center after the timeout period.
AFD	Disabled (Default) Enabled	Activates the display of AFD markers in the Message Center of the Picture display.
Vchip	Disabled (Default) Enabled	Activates the display of V-chip markers in the Message Center of the Picture display.
ST309 Date	Disabled (Default) Enabled	Displays the date in ST 309 format: dd mmm yyyy . Once enabled, the date is displayed in the Message Center.
SCTE104 Detection	Disabled (Default) Enabled	Activates the detection of SCTE104 packets in ancillary data and displays the message OpID, indicating the message type, in the selected Hex or decimal format.
SCTE 104 OpID Format	Decimal (Default) Hexadecimal	Defines whether to display the OpID of the SCTE104 message type in decimal or hex format.
Input Name	Disabled (Default) Enabled	Displays the defined source input name of the video stream, for example, the ID of the originating camera.
Input Name Configuration...	Opens Input Name Configuration Dialog Box.	Use the Input Name Configuration dialog to enter a source input name manually or to extract a name from the ancillary data.

Item	Options	Description
On Video Loss (IP ST 2110 Mode)	Black Screen Freeze Last Frame	Choose what should be displayed in the Picture window in the event of video loss.

Using Closed Captions

Closed captions (or subtitles in Europe) are the text-based, encoded and hidden information included in the ancillary data of the video signal, which can optionally be displayed by the viewer. The unit can detect closed captions carried in the ancillary data and display them, when enabled, in the Analyzer - Picture Instrument for monitoring purposes.

The following closed caption formats are supported:

- **OP47** (or SMPTE RDD-08): European and Australian standard for closed captions/subtitles on HD TV. Supports the following languages: Czech, English, Finnish, French, German, Hungarian, Italian, Portuguese, Slovakian, Spanish and Swedish
- **608** and **608 in 708**: CEA-608 (or EIA-608) is a legacy US standard for closed captions. CEA-708 is the current US standard for closed captions on HD TV and is backward compatible with CEA-608. CEA-708 acts as a wrapper for embedded CEA-608 closed captions, enabling the unit to extract 608-standard closed captions from 708-standard ancillary data. Supports the following languages: Danish, English, Finnish, French, German, Italian, Portuguese, Spanish and Swedish.

When configuring the **Analyzer - Picture** instrument to display closed captions, use the Ancillary Status and/or Ancillary Inspector instruments to establish which closed caption system is present in the video signal. The ANC Status display will show CEA-608, CEA-708 and OP47 data packets included in the vertical ancillary area of the SDI framework. You can then select the corresponding closed caption option from the Analyzer - Picture submenu.

To display closed captions in the Picture view, enable one of the **Closed Captions** options from the Analyzer - Picture submenu and select the desired target page (OP47) or field (608 and 608-in-708) for the appropriate standard.

When enabled, closed caption/subtitle text is displayed in the Picture area as defined by the format of the selected closed caption standard.

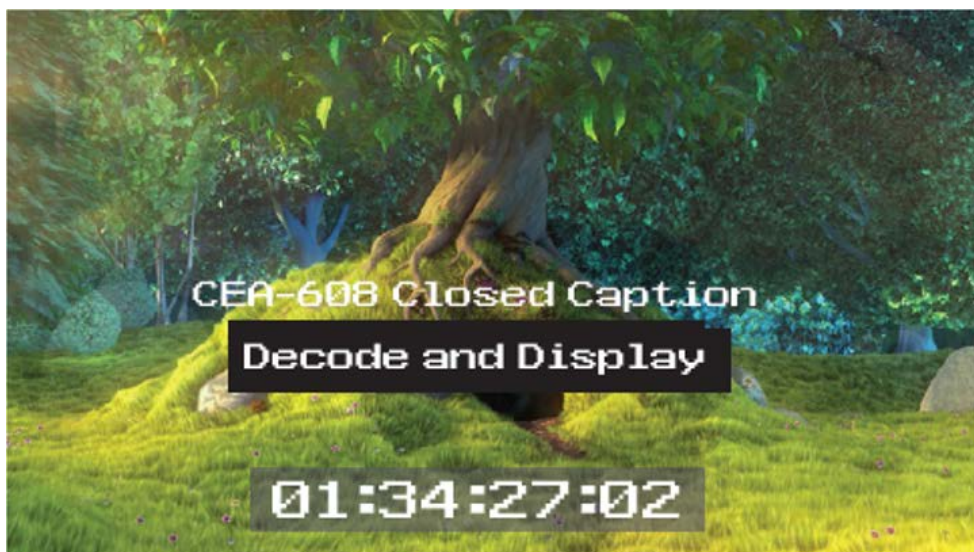

Figure 9-3: Closed Captions in the Picture and Picture Copy Windows

The CEA-708 closed caption system (used in the USA and Canada for high definition (HD) video) embeds information in the VANC area of the HD-SDI video framework and uses data identifier (DID)

0x61 (Hex) for the Caption Distribution Packet (CDP). Typically this supports up to 6 different closed caption streams (or services).

The OP-47 closed caption system (used in Europe and Australia for HD-SDI) embeds closed caption text in the VANC area of the SDI-HD video framework using DID 0x43 (Hex). This system supports closed caption pages in the range 0x100 to 0x8FF (Hex).

Using Dual Picture Instruments

You can now open two instances of the **Analyzer - Picture** Instrument, where the second instance is a copy of the first. The same video signal is displayed in both windows and some features, if enabled, are common to both (see below).

When positioned alongside each other, you might use the dual Picture windows to monitor closed captions in different languages, or to compare different screen safe areas.

Open two Analyzer - Picture Instruments as follows:

1. Open the first **Analyzer - Picture** Instrument from the PHABRIX instrument launch menu.
2. Open the PHABRIX instrument launch menu again and select the option: **Analyzer - Picture Copy**.

You can now manage most overlay elements (excluding the ATC, OP-47 Page and optional HDR features, which are common to both windows) of the two Picture instruments independently using the submenu for each window.

Features common to both windows:

- Ancillary Time Code
- Position of Picture Cursor when enabled
- Closed Caption Standard
- OP-47 page
- All optional HDR functions, see the section ["HDR Heat-map \(False Color Overlay\)" on page 15-6](#).

Features that can be adjusted independently in both windows:

- Picture Safe Areas and Image Center Crosshairs
- Activation of Picture Cursor
- Field for 608 or 608-in-708 closed captions
- All Message Center features.

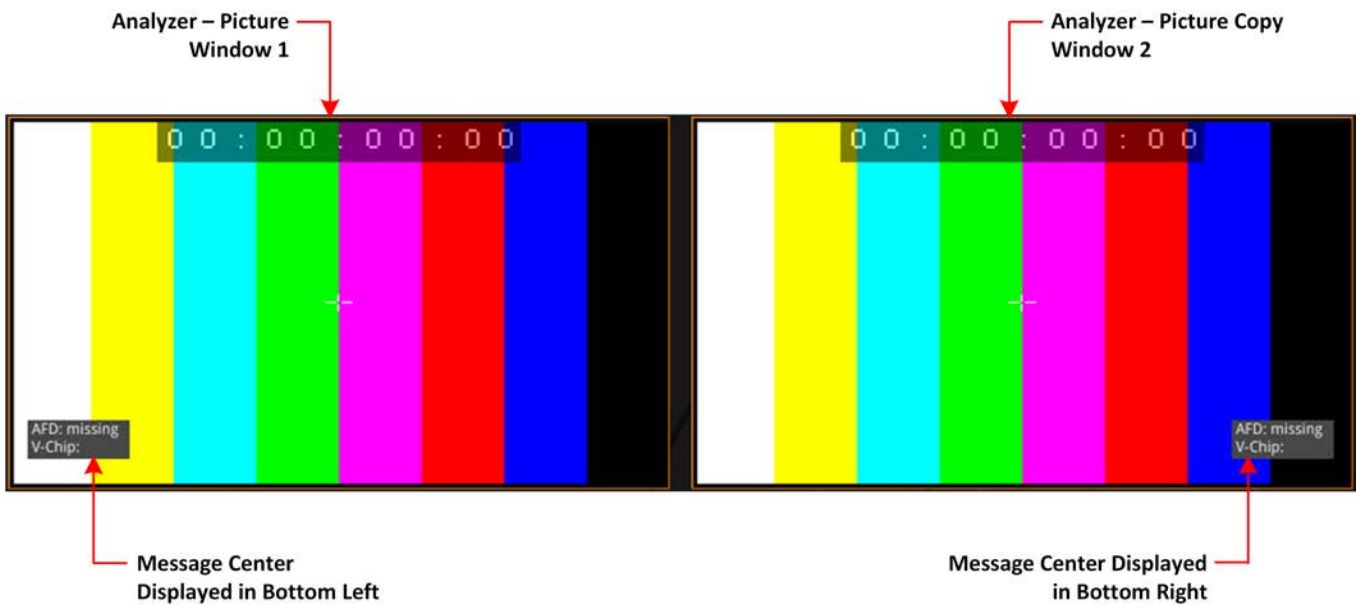

Figure 9-4: Two Picture Windows Displayed Side-by-side

Monitoring Closed Captions in Dual Picture Instrument Windows

If required, you can open a copy of the Analyzer - Picture instrument to have two Picture windows open at the same time. You can use this feature to monitor closed captions in a different language alongside the original language.

Select different language closed captions in dual Picture windows as follows:

1. In the first Picture window, select either of the closed caption standards: 608 or 608-in-708. This will also be automatically selected in the Picture Copy window.
2. In the first Picture window, set the option **608 Field** to **Field 1**.
3. In the Picture Copy window, set the option **608 Field** to **Field 2**.
The unit will now source the closed captions from the two different fields.



Figure 9-5: Dual Analyzer - Picture Instruments Showing Closed Caption Panel

When using either closed caption standard **608** or **608 in 708**, select a different field (Field 1 or Field 2) in each Picture Instrument to display a different language in the Picture Copy window.

Note: The OP-47 closed caption page, when selected, is linked between Picture windows so that the same page is displayed in both the Picture window and the Picture Copy window.

Picture Cursor

The Picture Cursor consists of two intersecting horizontal and vertical dashed lines. With the option **Picture Cursor** enabled, you can position the intersection of the cursor either by clicking the mouse anywhere inside the window boundary, or more precisely, by specifying the exact line and pixel in the submenu. The **Line** value adjusts the vertical component of the Picture Cursor and the **Pixel** value adjusts the horizontal component.

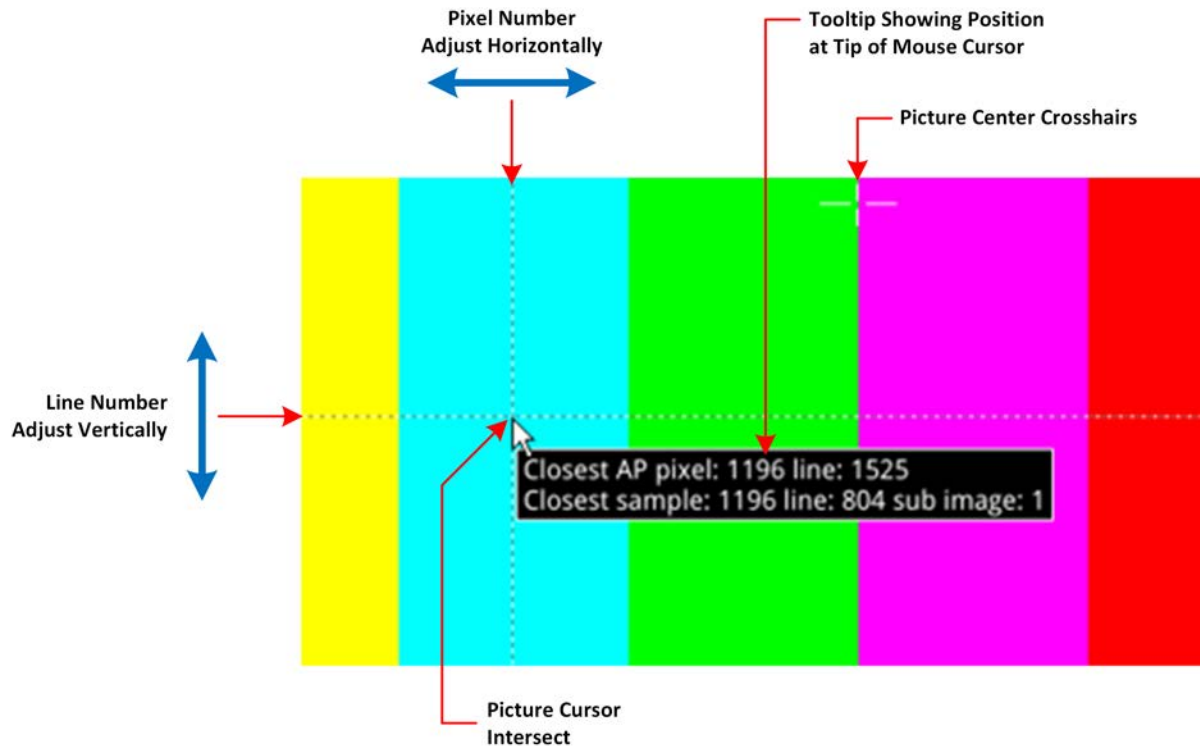

Figure 9-6: Two Picture Windows Displayed Side-by-side

If you hover the mouse over the intersection of the Picture Cursor, the unit displays a tooltip showing the actual picture position by line and pixel. This feature is dynamically linked to both the Waveform and Dataview instruments so that measurements from the selected picture position can be taken from these tools at the same time.

Note: When using the Dataview Analyzer together with the Picture and Waveform Analyzer instruments, keep in mind that the Dataview includes horizontal blanking, and so uses transport line numbers, and not active picture line numbers.

Using the Picture Safe Areas

The **Analyzer - Picture** instrument features picture safe areas designed according to the EBU Recommendation R95 "*Safe Areas for 16:9 Television Production*".

Picture safe areas define the part of the picture that can be viewed without compromise on a TV or movie screen.

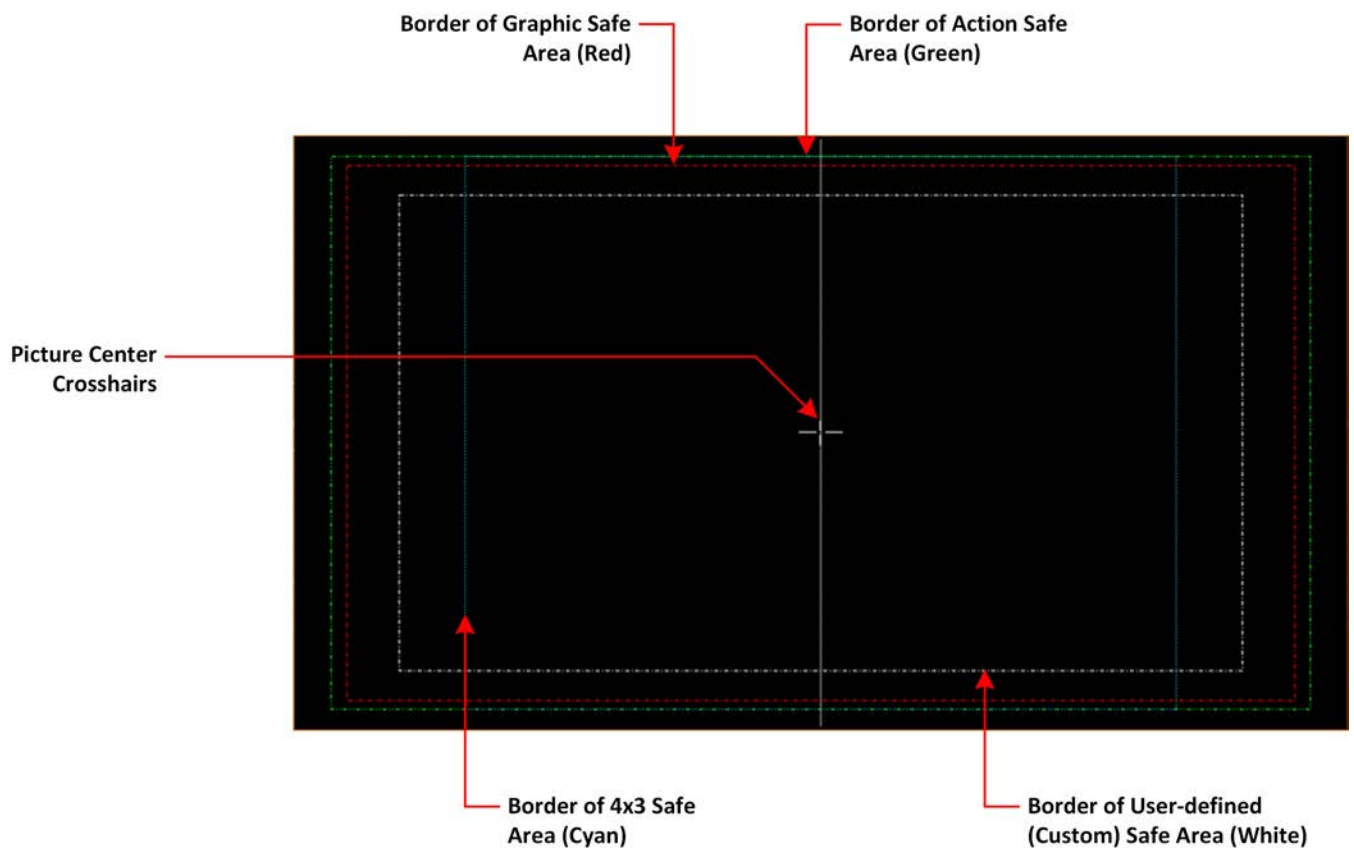

Figure 9-7: Picture Safe Areas Showing Border Colors

The Analyzer - Picture instrument can generate three pre-defined, independent safe areas for the following:

- **Graphics (16:9):** Smallest of the safe areas; ensures that all essential graphics are protected inside this area. The border of the Graphics safe area is 10% in from all edges of the screen.
- **Action (16:9):** Larger than the Graphics safe area; ensures that all essential program content is protected inside this area. The border of the Actions safe area is 5% in from all edges of the screen.
- **4x3:** Shows the safe area for HD video to be viewed on domestic TVs still using a 4:3 aspect ratio.

The Picture Instrument also includes a facility to generate a user-defined safe area, which enables you to set the height and width of the safe area or a vertical or horizontal offset from the top/bottom and left/right edges of the picture, respectively. Using this facility, you can define safe areas to comply with other international safe area standards.

In addition, when enabled, you can use the **crosshairs** function to display crosshairs marking the center-point of the picture.

The unit currently supports HD 16:9 formats, providing safe areas for 16:9 HD, 3G and UHD picture formats.

In combination with the dual Picture windows, you might use the safe areas feature, for example, to compare the safe area of an HD service with a simulation of either a second language HD service or an SD (4:3 or 16:9) version of the service. The SD 4:3 version may be created either by scaling the 16:9 image (linear or non-linear), cropping the 16:9 image, or a combination of both these methods.

For more information, see the EBU Recommendation R95 "*Safe Areas for 16:9 Television Production.*"

Displaying the Picture Safe Areas

Activate a safe picture area in either of the Picture windows as follows:

1. Right-click in the Picture window to open the Instrument submenu.
2. To display one of the standard safe areas, simply select **Enabled** from the corresponding drop-down list. You can differentiate the safe areas by the color of their border, for example:
 - Action Safe Area - Green dashed-line border
 - Graphics Safe Area - Red dashed-line border
 - 4x3 Safe Area - Cyan dotted-line border
3. To display a custom safe area, set the **Custom Safe Area** to **Enabled**. This displays additional fields in which to specify the height and width of the custom safe area, using either:
 - An absolute percentage of the screen area for the safe area to occupy, or
 - A percentage offset from the horizontal and vertical edges of the picture.

Note: The user-defined custom safe area is displayed with a white dashed-line border

Using the Message Center

The **Message Center** is a designated area of the Analyzer - Picture instrument intended to alert you to the receipt of certain messages transported as packages in the ancillary data stream. The Message Center facilitates quality control of the source video material, both before and during transmission. On identifying one of the target message types, the Message Center decapsulates the message and displays an appropriate marker, text or ID to reference the message. You can configure the Message Center to display the following:

- **V-chip Marker:** Identifies a parental guidance rating, used primarily in the US and Canada, to categorize age-sensitive material in a TV program. The V-chip hardware in the receiving television can be configured by the viewer to block certain categories of V-chip ratings as desired.
- **ST309 Date:** The date in ST 309 format: **dd mmm yyyy**
- **AFD Marker:** The Active Format Description is a set of codes used to identify the aspect ratio of the video signal and the protected areas of the picture.
- **Input Name:** The defined source input name of the video stream
- **SCTE104 OpID:** The industry standard for including specific program signals and markers in the video signal at various timepoints, for example, program parts, commercial breaks, etc.

V-chip data is included with closed caption data of type CEA-608 or CEA-608-in-708. V-chip data is not currently available with closed captions of type OP-47. If 608 or 608-in-708 closed captions are enabled but unavailable and you then enable the V-chip marker, you will see that the V-chip label in the Picture submenu is displayed in yellow as a warning. Furthermore, if OP-47 closed captions are enabled, together with the V-chip marker, the V-chip label in the Picture submenu is displayed in yellow

The Message Center separates messages into either *static* or *dynamic* message types. When enabled, static messages are always displayed in the Message Center and indicate the presence of a V-chip or Active Format Description (AFD) code in the ancillary data. Dynamic messages, however, are displayed for a configurable timeout period (in seconds) after which they are removed from the Message Center. The unit manages the OpIDs of SCTE104 packages, detected in the ancillary data, as dynamic messages. Each consecutive SCTE104 packet received by the unit replaces the previous displayed OpID.

For ease of viewing, you can choose the specific quadrant of the Analyzer - Picture window in which to display the Message Center from:

- Top-left quadrant
- Top-right quadrant
- Bottom-left quadrant
- Bottom-right quadrant.

Note: The Message Center is displayed only when you enable at least one of the message types (AFD, V-Chip, ST309 Date, SCTE104 or Input Name) in the submenu.

The layout of the Message Center adapts so that it always displays the static messages closest to the picture edge, depending on the selected screen quadrant in which it is located. This ensures that the V-chip and AFD codes are always displayed in the same position in the window.

Dynamic SCTE104 OpID codes are appended either above or below the static messages, again depending on the quadrant in which the Message Center is located.

The AFD packets in ancillary data are used to identify the aspect ratio of the video signal and key program indicators at various timepoints.

You can hover over a SCTE104 OpID in the Message Center to display a tooltip containing the actual text of the message.

Note: V-chip, AFD ST309 Date, SCTE104 OpID and Input Name data packets will also appear in the **Analyzer - Ancillary Status** Instrument and you can view the corresponding packet contents in the **Analyzer - Ancillary Inspector** Instrument.

SCTE 104 Packet Detection

SCTE-104 is the broadcast industry standard for including specific program signals and markers in the video signal, for example, program parts, commercial breaks, etc.

When this option is enabled, the Analyzer - Picture window displays a list of SCTE-104 messages in the Message Center, with the most recent displayed at the top of the list. On receipt, the OpID code of each SCTE-104 message is displayed for at least two seconds, depending on the configured timeout period.

The unit displays the following information for each SCTE-104 message received:

- SCTE-104 operation ID (OpID) - identifies the SCTE104 message type.
- Message type as screen tip by hovering over the OpID.

You can choose to display the message OpID in either hexadecimal or decimal format.

If you are interested in SCTE-104 messages, it is recommended to enable SCTE 104 messages in the Event Logger so that the full message type is saved to the logfile.

Defining Source Input Names

The unit provides a facility to enter identification strings for input sources, for example, cameras, etc. to identify the source of the input stream. The source ID is displayed in the Message Center for 5 seconds, with this 5 second timeout being reset each time the unit receives an Input Name ancillary packet. If the unit receives no further Input Name ancillary packets after 5 seconds, then it reports the Input Name as **Missing** in the Message Center.

You can choose either to enter the input name manually, or configure the Data Identifier (DID) and Secondary Data Identifier (SDID) value of the Input Name in the ancillary data of the input stream.

The Input Name is an ancillary data packet with the following message structure:

Ancillary Data Flag			DID	SDID	DC	Data	CS
0x000	0x3ff	0x3ff	0x53	0x49	nn	up to 12 ASCII chars	

Figure 9-8: Input Name Message Structure

In addition, you can define a prefix to be applied to the source input name, for example: **Input ID:**

Enter a source Input Name as follows:

1. Right-click in the Picture or Picture - Copy window to open the submenu.
2. Select **Enabled** from the **Input Name** dropdown.
This displays the **Input Name Configuration...** button.
3. Click **Input Name Configuration...** to open the Input Name Configuration dialog.
4. Using a USB keyboard or over a VNC connection, configure an input name as follows:
 - a. If you require a standard prefix for your input names, enter the prefix text string into the **Prefix** field, for example **Source ID:**
 - b. To enter an input name manually, click the **User Entered** option button and enter the name using up to a maximum of 12 characters.
 - c. To extract an input name automatically from the ancillary data in the input feed, click the **Ancillary Data** option button and select the target DID and SDID. You can specify the DID/SDID using either decimal (default) or hex notation.
5. Click OK to save the input name.

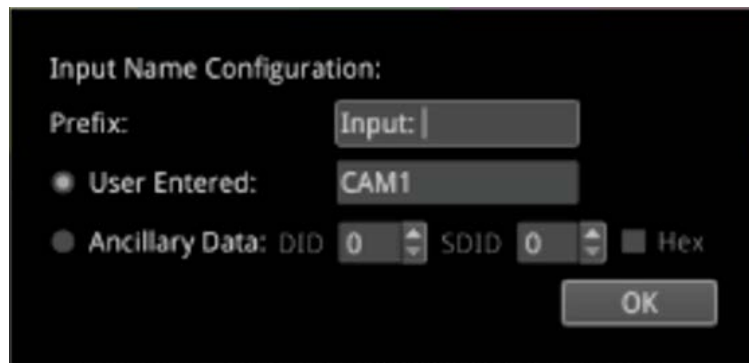

Figure 9-9: Input Name Configuration Dialog Box

Displaying the Ancillary Time Code (ATC)

Time and control code information, used to identify discrete video frames, is carried as the payload of packets located in the ancillary data space of the video signal. When you enable the ATC option in the Analyzer - Picture submenu, the ancillary time code is displayed in a panel overlaid across the Picture window.

The ATC is a 13 character time code with the following format:

ATC Format: (Integer Frame Rates)

hh : mm : ss : ff

ATC Format: (Non-integer Frame Rates)

hh : mm : ss ; ff

ATC Example:

00 : 00 : 00 : 00

ATC Example:

00 : 00 : 00 ; 00

Figure 9-10: Format and Example of the Ancillary Time Code

Where:

- Colon (:) Separator between seconds and frames indicates Integer frame rates
- Semi-colon (;) Separator between seconds and frames indicates drop-frame, non-integer frame rates (for example, 23.9, 29.9, 59.9, etc.)
- hh = hours (24 hour clock)
- mm = minutes
- ss = seconds
- ff = frame number

When enabled, the ATC panel is displayed in the top-center of the window by default and you can adjust both its position down the center line (top, middle or bottom) and the panel size (small, medium, large or automatic size adjustment) for ease of viewing.

The option **Anc Time Code Field** allows you to activate the display of an optional final digit in the time code, after the two digits of the frame number. If desired, you can use this digit as a field identification flag for either 25 Hz or 24/30 Hz.

Note: Linear Timecode (LTC) is not currently supported.

On Video Loss (IP ST 2110 Mode)

In the event of video loss, you can choose what should be displayed in the Picture, if the video signal is lost, from either of the following options:

- Black Screen
- Freeze Last Frame



Overview

The **Waveform** instrument provides various analysis settings including Single Line Mode and Picture Cursor control.

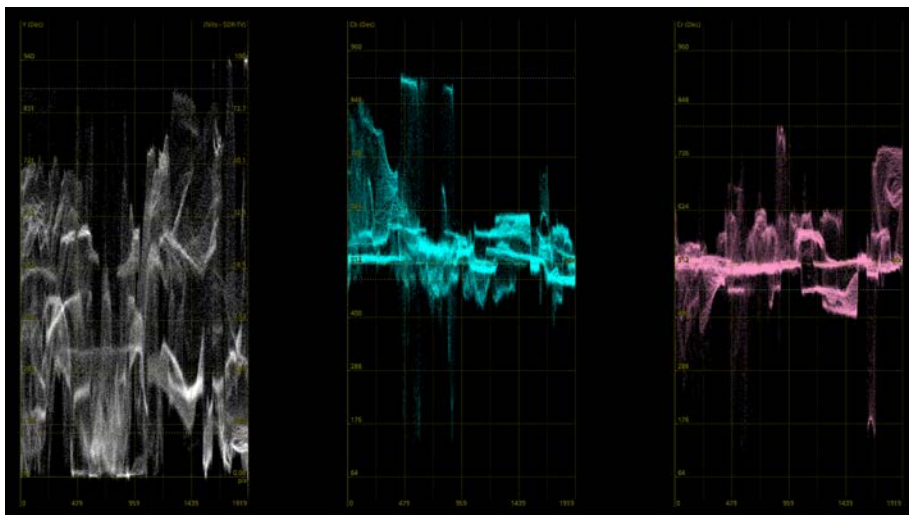

Figure 9-11: Analyzer - Waveform Instrument

When the option **Picture Cursor** is enabled, the cursor is dynamically linked to the cursor in the Picture instrument, and to Dataview navigation. Clicking the cursor in a new position in the Waveform window updates the pixel and active picture line position selected in the Picture instrument, and the pixel and transport line position selected in Dataview.

Instrument Menu Options

You can use and view Markers in the Cb Cr waveforms when you enable Markers in the Vectorscope instrument. The position of the markers tracks the positioning of the user markers in the Vectorscope.

Right-click in the Waveform area to access the waveform setup options:

- Parade Mode > [YCbCr, Y, Cb, Cr, RGB, GBR, YRGB, YGBR, Red, Green, Blue]
- V Scale > [Percent, Hex Value, Decimal Value, Millivolts]
- V Scale Nits > [Hidden, Right Side, Left Side]
- H Scale > [Pixels, % Line]
- Filter > [Flat, Low Pass, Raw]
- Single Line Mode > [Enabled, Disabled]
- Single Line Mode > Enabled > Line Number > [1 to Total no. of Lines for current standard]
- Picture Cursor > [Enabled, Disabled]
- Picture Cursor > Enabled > Pixel Number > [0 to (Total no. of Pixels for current standard -1)]
- Diffuse White Marker > [Enabled, Disabled]
- User Markers (%/Dec/mV) > [Enabled, Disabled]
- User Markers > Enabled > Marker 1 > [slider, bottom to top]
- User Markers > Enabled > Marker 2 > [slider, bottom to top]

- H Magnification > [slider 1.00...10.00]
- H Magnification > H Position > [slider, left to right]
- V Magnification > [slider 1.00...4.00]
- V Magnification > V Position > [slider, bottom to top]
- Brightness > [slider 1..31]
- Gamma > [slider 1..255]
- Persistence [slider 1..255]
- Monochrome Mode [Enabled, Disabled]
- S-Log3 Mode [S-Log3, SR Live] for HDR video signals, see the section ["Advanced HDR Toolset" on page 15-2](#)



Overview

The Vectorscope is part of the video core toolset that provides X-Y analysis of the video signal(s).

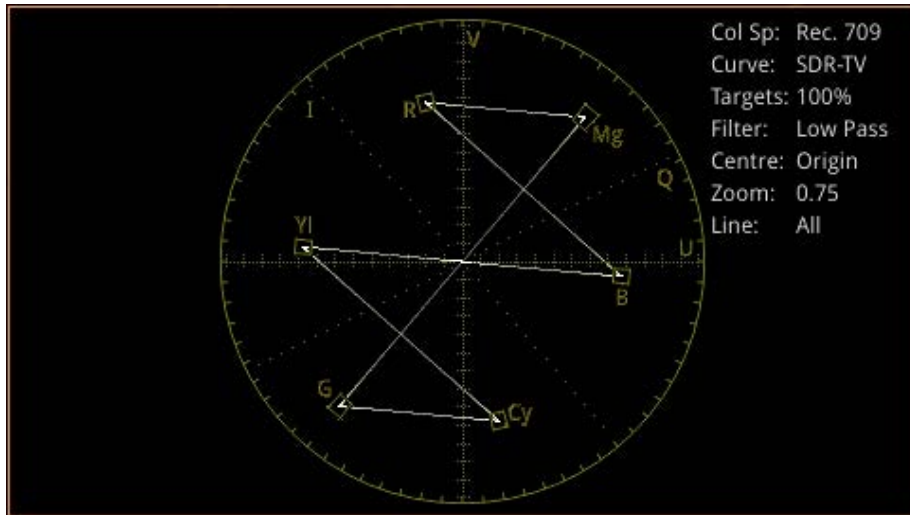

Figure 9-12: Analyzer - Vectoscope Instrument

Instrument Menu Options

Access the setup options for the Vectorscope by right-clicking in the vectorscope area:

- Targets > [Off, 75%, 100%]
- User Markers > [Enabled, Disabled]
- User Markers > Enabled > Marker Selected > [Marker 1, Marker 2] > Marker Angle > [slider 0.00...359.99]
- User Markers > Enabled > Marker Selected > [Marker 1, Marker 2] > Marker Gain > [slider 0.00...100.00]
- I/Q Axes > [Off, I Only, Q Only, Both]
- Filter > [Flat, Low Pass, Raw]
- Center > [Origin, Red, Green, Blue, Magenta, Cyan, Yellow, Marker 1, Marker 2]
- Single Line Mode > [Enabled, Disabled]
- Single Line Mode > Enabled > Line Number > [1 to Total no. of Lines for current standard]
- Zoom > [slider 0.50...4.00]
- Brightness > [slider 1..31]
- Gamma > [slider 1..255]
- Persistence [slider 1..255]



Overview

The **Analyzer - CRC Analysis** window checks for CRC (Cyclic Redundancy Check) errors in the received signal. The number of SDI input failures, the last failure time, total analysis time, and error rate are also displayed. Depending on the input required for the standard under test (i.e., quad, dual, or single input) the Sub Image columns will display any errors occurring in each of the Sub images. In the larger window size, the Link rows will display any errors occurring per Link.

Analyser - CRC Analysis		Analysis time: 2h 58m			
Input Failures: 257		Last Failure Time: 11m 6s			
	Sub 1	Sub 2	Sub 3	Sub 4	
C-CRC-Err	0	0	0	0	
Y-CRC-Err	0	0	0	0	
ANC-CS-Err	1	0	0	0	
Rate (/s)	0.002	0.000	0.000	0.000	
OK Time	9m 53s	11m 6s	11m 6s	11m 6s	
Active Picture Changes	0	0	0	0	
Active Picture CRC	EC9D CAC0	FE4F 7B21	EC9D CAC0	FE4F 7B21	

Figure 9-13: Analyzer - CRC Analysis Instrument

The **OK Time** shows the length of time an image/sub image has been received without error.

The PHABRIX **Active Picture CRC** is created by the receiver for each image or sub-image video frame (dependent on standard) and displayed.

The instrument detects and counts changes in the active picture CRC. This can be used to show that an SDI path is transparent and error free.

The reported CRC (error) Rate(s) is the number of instances of the addition of the Y- and C-channel CRCs and ANC checksum errors in each second.

- Y- and C-channel CRCs are calculated for each video line in accordance with SMPTE Standards
- ANC checksums are calculated for each individual ANC packet.

Errors are collected from the analysis start time and the reported error rate per second is the total number of errors divided by the total time of analysis.

Instrument Menu Options

You can access the submenu by right-clicking in the instrument window.

You can choose to ignore CRC errors on the switching line by enabling **Ignore CRC on switch lines** in the submenu:

- Ignore CRC on switch lines > [Enabled, Disabled]

You can choose to clear the counters on input failure if required by enabling **Reset errors on Input failure** in the submenu:

- Reset errors on Input failure > [Enabled, Disabled]

To reset the instrument:

- Reset errors
- Reset errors and running time.

Audio Signal Analysis Instruments

This chapter describes the Audio analytical Instruments and includes the following sections:

- [Analyzer - Audio Channel Status](#)
- [Analyzer - Audio Meters](#)
- [Analyzer - Loudness Monitor](#)

Overview

The **Analyzer - Audio Channel Status** Instrument displays detailed information about the available audio channels.

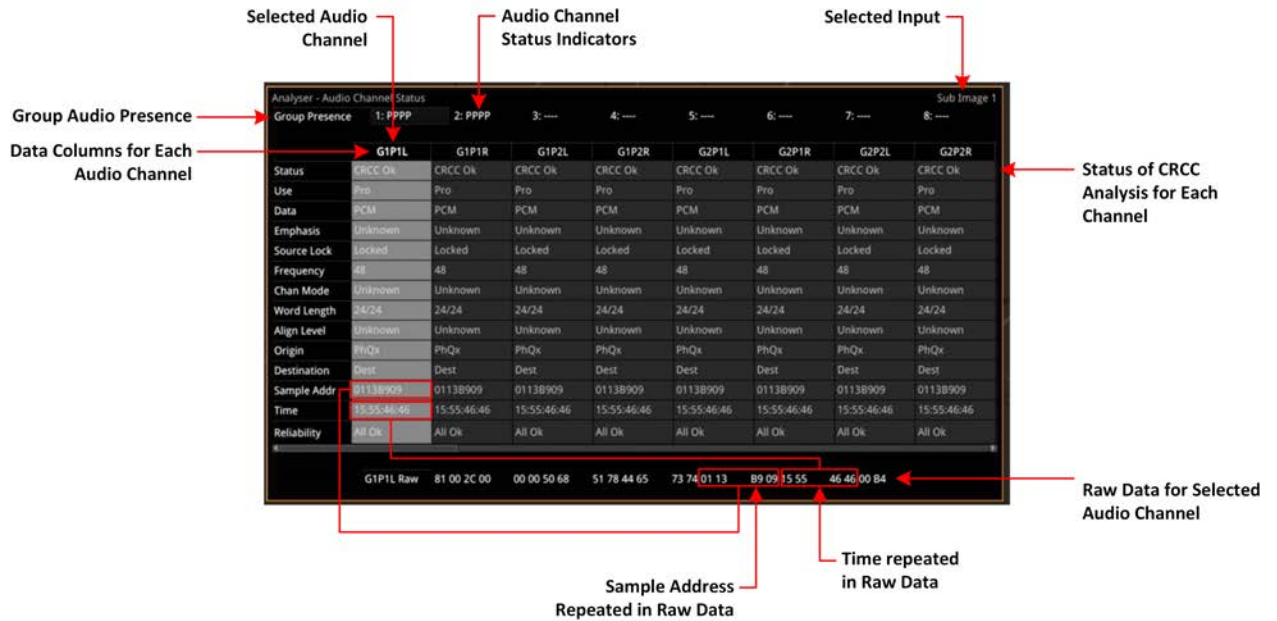

Figure 10-1: Analyzer - Audio Channel Status Instrument

The Group Presence is defined in the upper row of the **Analyzer - Audio Channel Status** display. For each channel, one of the following channel status indicators is displayed:

- -: No audio
- P: PCM audio present
- D: Dolby Digital packets present
- +: Dolby Digital Plus packets present
- E: Dolby E packets present
- ?: Unspecified data present.

In addition, the following information is displayed in the main data table for each audio channel:

- **Channel Status:** Result of the cyclical redundancy check checksum (CRCC), for example: CRCC Ok
- **Use:** Intended purpose of the audio signal.
- **Data Type:** Digital sampling method employed, for example: PCM (pulse-code modulation)
- **Emphasis:** Type of signal pre-emphasis applied to the audio signal.
- **Source lock:** Indicates whether the source is locked to an external time sync, for example: Locked
- **Frequency:** Audio sample frequency in kHz, for example: 48
- **Channel Mode:** Represents the relationship between each audio channel pair.
- **Word Length:** Represents the audio word length, for example: 24/24

- **Align Level**
- **Origin:** Four ASCII characters indicating the channel origin, for example: **PhQx**
- **Destination:** Four ASCII characters indicating channel destination
- **Sample Address:** A rolling counter that increments with each 48 kHz audio sample
- **Time:** Local time of the encoded audio
- **Reliability:** Contains information about the reliability of the channel status word, for example: All Ok.

Use the horizontal and vertical scroll bars to view the full table of channel columns and audio status parameters.

Raw Data Display

You can click on an audio channel column to select it and display the raw data for that channel in the bottom row of the window.

Each AES3 audio sample, includes the Sample Address and Time occupying eight bytes (14 to 21) with a reliability indication in byte 22 and the cyclical redundancy check checksum (CRCC) in byte 23. With each audio sample, the Sample Address and Time are different for each sample, so bytes 14 to 21 will change, as will the checksum in byte 23.

Instrument Menu Options

The following menu options are available for configuring the **Analyzer - Audio Channel Status** Instrument:

Table 10-1: Analyzer - Audio Channel Status Menu Options

Item	Options	Description
Input Select (SDI / 2022-6 modes)	Sub Image 1, Sub Image 2, Sub Image 3, Sub Image 4, AES IO	Selects the target input audio source for analysis. The selected input is displayed in the top-right corner of the instrument.
Input Select (IP 2110 mode)	Meters 1+ 2 Flows, AES IO	In IP 2110 mode, you can choose the audio flows currently selected on both Analyzer - Audio Meters windows, or AES IO. Audio Channel Status information will only be available with a flow using ST 2110-31 (AES 3 transport)



Overview

The **Analyzer - Audio Meters** instrument displays 16 audio meters together with peak level indicators and indication of audio pair correlation. In addition the numeric values are displayed in dBFS below each meter.

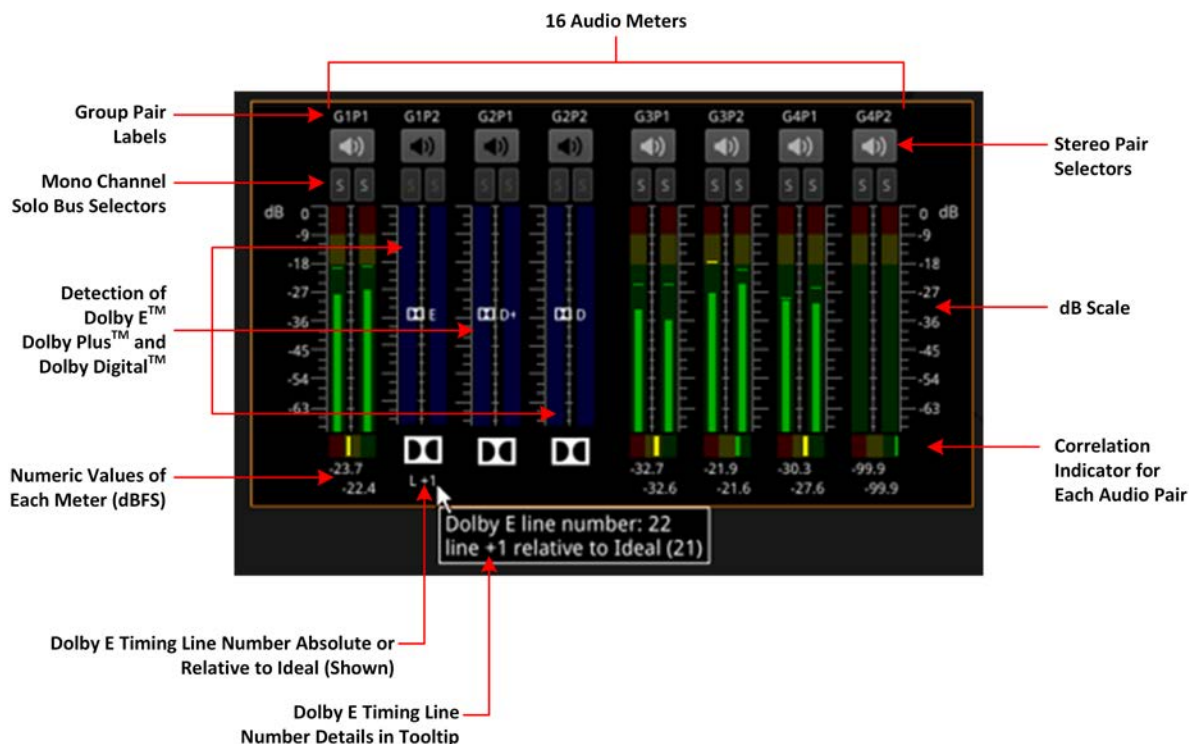

Figure 10-2: Analyzer - Audio Meters Instrument

Dolby E™, Dolby D™ and Dolby D+™ streams are detected by the system with Dolby stream presence indicated in blue. For an SDI signal carrying embedded Dolby E audio, the Dolby E timing line number is also displayed below the detector, either as an absolute value or relative to the *Ideal*/line number specified for that video standard.

The HDMI instrument output carries a stereo pair of audio, as does the SDI instrument output. The same signal is made available on pins 7 and 8 of the 26-way D-type connector on the rear of the chassis.

To monitor a stereo pair, select the speaker icon above the target audio meter. To select a mono channel, click the corresponding solo bus located between the audio meters and the speaker icons.

You can enable up to two audio meter instrument windows providing 32 simultaneous channels of audio metering. Each window can be assigned to monitor groups 1 to 4 (defined in SMPTE ST 299-1) or groups 5 to 8 (defined in SMPTE ST 299-2) in any of up to four potential sub-image ANC areas as defined in SMPTE ST 2082-10. You can scale the size of each audio window to occupy from 1/32 to 1/4 of the screen area.

The following figure provides a comparison of the available audio metering scale options and illustrates the relative scope and alignment levels. For each scale you can select an appropriate ballistic option.

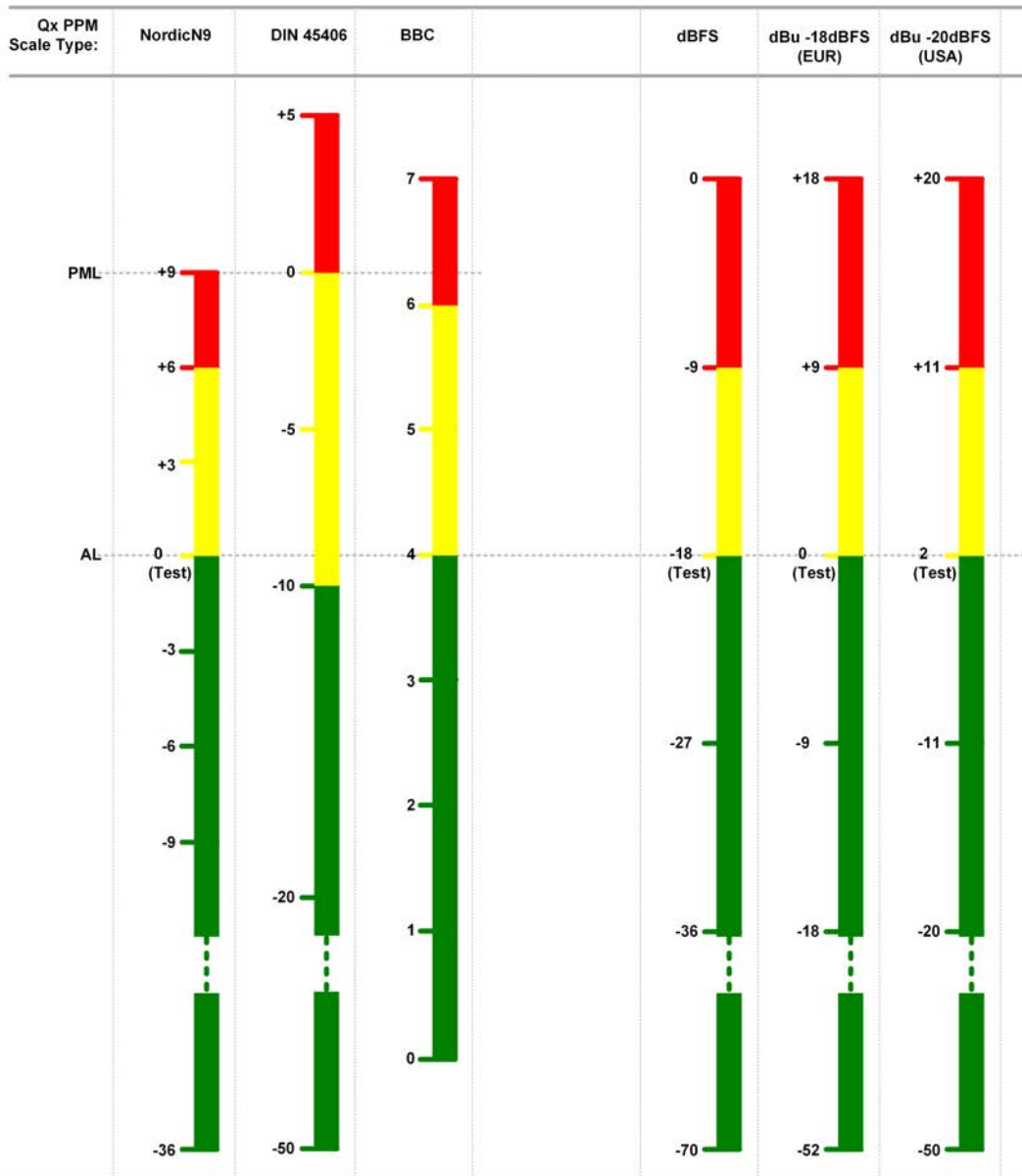

Key:
 AL – Alignment Level
 PML – Permitted Maximum Level

Figure 10-3: Comparison of Audio Metering Scales

Instrument Menu Options

The following menu options are available for configuring the **Analyzer - Audio Meters** Instrument:

Table 10-2 : Analyzer - Audio Meter Menu Options

Item	Options	Description
Input Select	Image/Sub-Image 1 Group 1-4 Image/Sub Image 1 Group 5-8 Sub-Image 2 Group 1-4 Sub-Image 2 Group 5-8 Sub-Image 3 Group 1-4 Sub-Image 3 Group 5-8 Sub-Image 4 Group 1-4 Sub-Image 4 Group 5-8 AES IO	Select the source for each pair of audio meters to meter simultaneously up to 32 audio channels in up to two Audio Meter instrument windows.
Ballistics	PPM Type I PPM Type II Vu VuFr Fast	Set the required peak program meter (PPM) ballistic responsiveness setting for the audio meters. PPM Type I emulates the performance of IEC 60268-10 Type I PPM style audio meters typically used by German broadcasters. PPM Type II emulates the performance of IEC 60268-10 Type II PPM style audio meters typically used by UK broadcasters. Vu emulates the performance of IEC 60268-17 Type I PPM style audio meters typically used by US and Australian broadcasters. VuFr emulates the performance of ITU-R Rec BS.645 style audio meters typically used by French broadcasters. Fast provides instantaneous attack ballistics.
PPM Scale	dBFS dBu -18dBFS dBu -20dBFS BBC DIN45406 NordicN9	Set the desired scale for the audio meters according to your standard operating model. The displayed graticule and audio levels change accordingly to reflect the selected scale.
Hat hold time	0.00...10.00, infinite	Sets the minimum time that the signal gate is held open in ms.
Monitor Buttons	Enabled (Default) Disabled	Toggle the display of Monitor icons for the audio meters.
Solo Buttons	Enabled (Default) Disabled	Toggle the display of Solo icons for each channel of a pair.
Dolby E Line Number	Relative to Ideal Absolute	Select whether to display the Dolby E timing line number relative to the ideal for the selected standard, or as an absolute line number.

Analyzer - Loudness Monitor



Overview

The **Analyzer - Loudness Monitor** instrument enables the metering and monitoring of loudness on the configured audio channels for either a stereo audio pair or 5.1 surround sound audio group.

The Loudness Monitor provides the following Loudness meters:

- **M**: Momentary loudness meter
- **S**: Short-term loudness meter
- **I**: Integrated loudness meter.

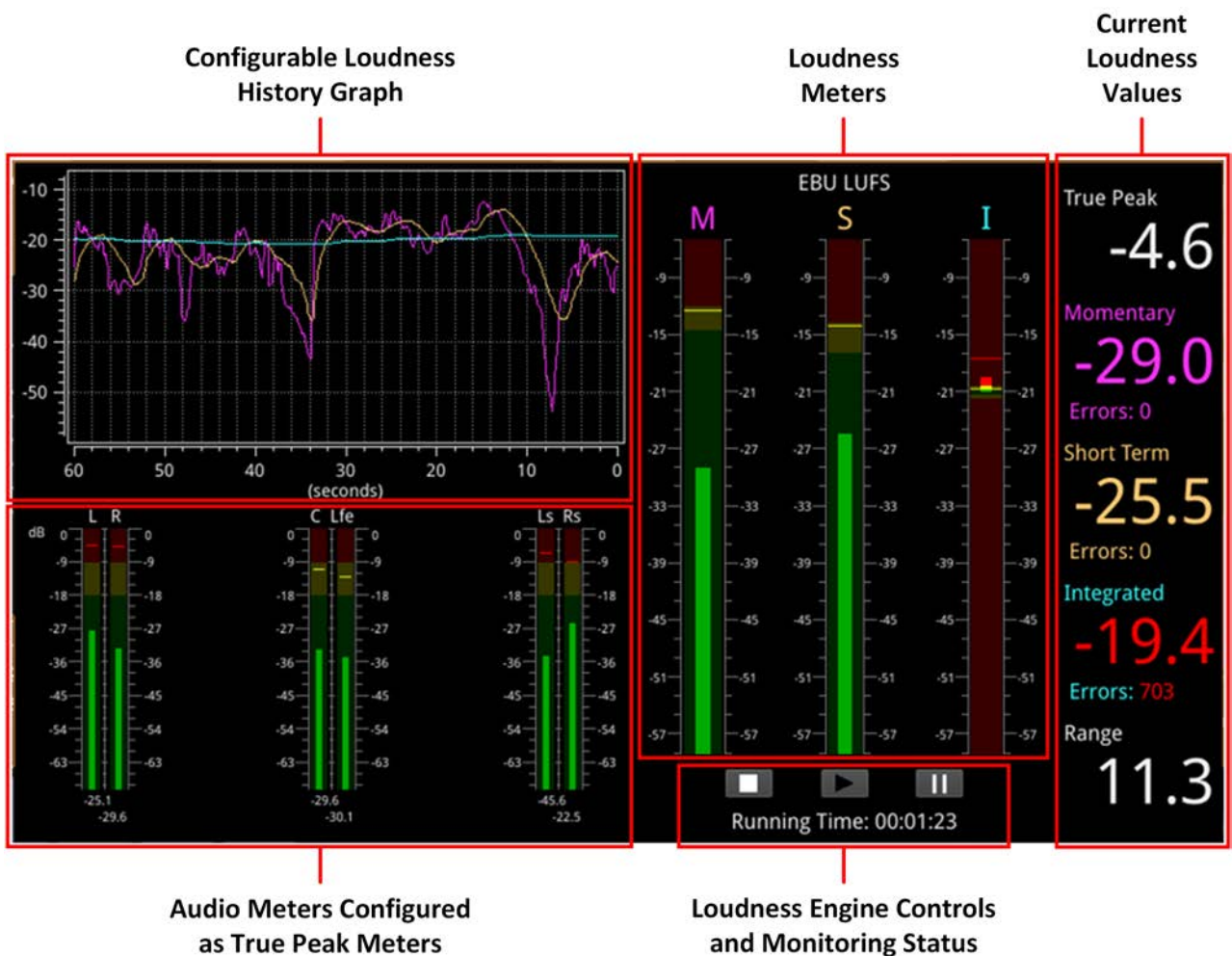

Figure 10-4: Analyzer - Loudness Monitor Instrument

Loudness is measured in accordance with the standards EBU Recommendation R128 and ITU-R BS-1770 which define the measurement over different time periods in terms of either:

- EBU Loudness Units Full Scale (**EBU LUFS**)
- EBU Loudness Units (**EBU LU**)
- ITU Loudness K-weighted Full Scale (**ITU LKFS**)
- ITU Loudness Units (**ITU LU**)

The Loudness Options menu allows you to:

- Open the Audio Assignment dialog to define the loudness monitoring mode (either stereo or 5.1 surround sound) and assign the audio input channels for loudness monitoring and measurement.
- Define the ballistics and PPM scale type for the conventional audio meters (in the Analyzer - Audio Meters instrument) and the True Peak meters in the Loudness Monitor.

Note: The choice of ballistics does not affect the reported true peak values in the true peak meters.

- Set the loudness standard (EBU or ITU) and units (LU, LUFS or LKFS).
- Configure the Loudness History graph.
- Enable or disable the individual loudness meters (M, S, and I).
- Configure target loudness levels and appropriate tolerances for each loudness meter and, in addition, set an alarm for the True Peak loudness value.
- Reset the True Peak value, the loudness monitoring session, or zero accumulated loudness errors.
- Define the logging duration and lifetime of the loudness logfiles and change the naming of the logfiles

The right-hand section of the window displays the actual loudness values of the assigned audio channels both graphically, in the three loudness meters and numerically, in the current values for Integrated, Momentary and Short Term loudness, on the right. This section also displays the True Peak value, together with a value for the Loudness Range.

When inside the configured loudness target and tolerance, the momentary, short-term and integrated values are displayed in the same color as their corresponding loudness meter. If the loudness value exceeds the configured tolerance for a particular meter, however, the corresponding value switches to a red color and an error count is incremented below the value. In addition, if the True Peak value exceeds the configured True Peak Alarm threshold, this value also changes color from white to red.

Three media controls below the Loudness Monitors are provided to enable you to start, stop or pause the Loudness Engine and consequently, the loudness monitoring session.

Note: The Loudness Engine controls do not affect the input source/media to the Loudness Monitor.

The left-hand section of the window includes the Audio Meters acting as inputs to the Loudness Monitor, together with a Loudness History graph, plotting the selected loudness values from the monitoring session in real-time.

For clarity of viewing, you can double-click the Loudness Monitor to display the window in quarter screen size.

Summary Loudness Monitoring Process

When monitoring an audio track or program for loudness, you will need to perform some, or all, of the following steps:

1. Open the **Analyzer - Loudness Monitor** from the PHABRIX launch menu.
2. Open the Audio Assignment dialog from the Loudness Options menu. Select the audio mode (2.0 stereo or 5.1) then assign the audio inputs.
3. Set the ballistics and scale type for the audio and true peak meters.

4. Select the Loudness standard and appropriate scale for the loudness monitors.
5. Enable which of the three possible loudness meters you want to use.
6. Set the graphing period and choose which traces to display in the Loudness History graph.
7. Set the loudness targets and tolerances for the active loudness meters.
8. Set the true peak alarm threshold.
9. Set the desired log duration and lifetime.
10. Click the **Play** button to start the loudness monitoring session.

These tasks are described in more detail in the following subsections.

Audio Assignment for Loudness Monitoring

You can select the audio inputs from the available audio channels to be monitored for loudness by opening the **Audio Assignment** dialog from the Loudness Options menu.

The unit's Audio Meter instruments can provide up to 32 simultaneous audio channels in SDI modes or 80 audio channels in 2110 mode.

In the SDI modes, you can assign any of the 32 channels of the left/right pairs in Groups 1 to 8 to the stereo or 5.1 audio inputs for loudness monitoring.

In 2110 mode you can assign any of up to 80 input channels to the stereo or 5.1 audio inputs for loudness monitoring.

First select the desired loudness monitoring **Mode** from the dropdown menu: either **Stereo** or **5.1** surround sound. In Stereo mode, only two input audio meters, Left (L) and Right (R) are displayed. In 5.1 mode, all six audio input meters are active as follows:

- **Left** (L)
- **Right** (R)
- **Center** (C)
- **Low frequency effects** (Lfe)
- **Left Surround** (Ls)
- **Right Surround** (Rs).

Note: The Loudness Monitor supports only the following channel order in surround sound mode 5.1: L, R, C, Lfe, Ls, Rs.

The Audio Assignment dialog then maps the incoming audio to the expected channel order of the Loudness Monitor.

In SDI modes, select the sub-image then the group/pair to use as stereo inputs to the loudness monitor from the dropdown lists. In 2110 mode, select the audio flow (AUD 1 or AUD 2) and then assign one of the 80 available channels using the selector.

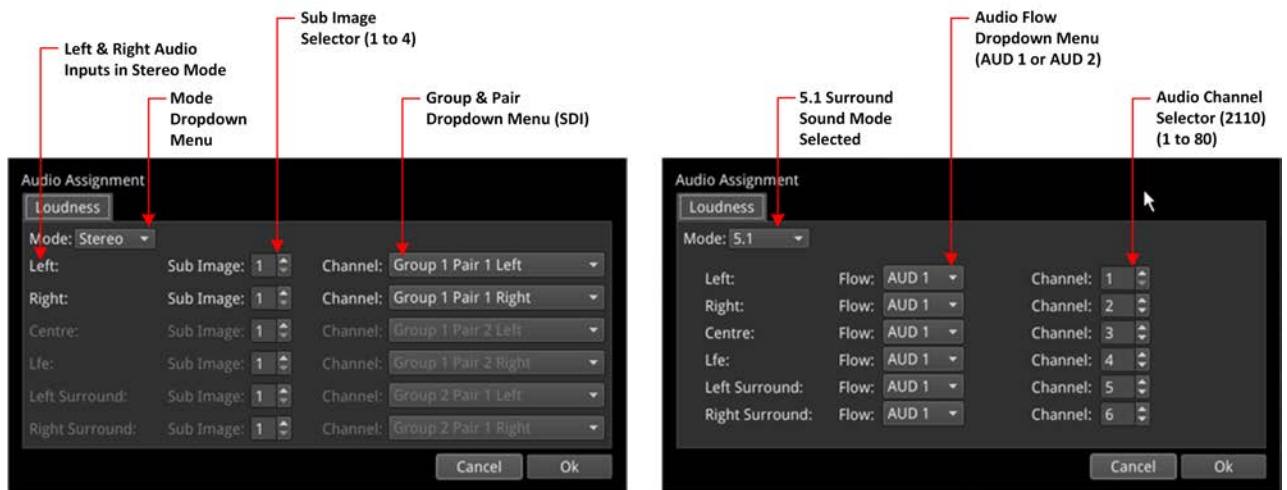

Audio Assignment in SDI Mode

Audio Assignment in 2110 Mode

Figure 10-5: Audio Assignment for Loudness Input in SDI and 2110 Modes

On completion, click **OK** to save your audio input mapping changes.

Audio Meters for Loudness Inputs

The audio meters displayed in the Loudness Monitor display the active audio levels for the selected mode and assigned audio channels.

In stereo mode, the two selected input channels are active in the Left (L) and Right (R) audio input meters.

In 5.1 surround sound mode, six input channels are active in all six audio input meters: L, R, C, Lfe, Ls and Rs as shown in the following figure.

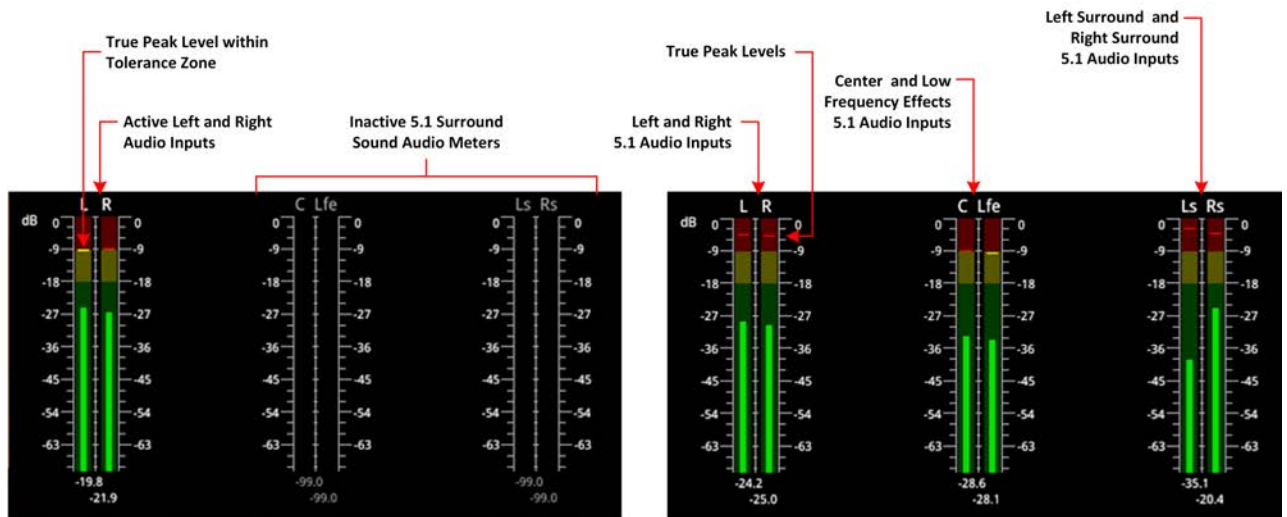

Audio Meters in Stereo Mode

Audio Meters in 5.1 Surround Sound Mode

Figure 10-6: Audio Meters for Loudness Inputs in Stereo and 5.1 Surround Sound Modes

The current True Peak levels are also displayed as a horizontal band in each of the active audio meters.

Understanding the Loudness Meters and Values

The Loudness Monitor features three individual loudness meters to measure momentary, short-term and integrated (also known as program loudness) levels across the different time periods defined in the selected standard. You can enable or disable each individual meter using the Options menu and set the Loudness standard and scale. The unit updates the loudness meters every 100 ms.

When enabled, the monitors give a visual indication, in real-time, of the current loudness level with the actual value displayed as a numeric in the right-hand column. The loudness value is also plotted in the Loudness History graph to generate a trace of the loudness trend over time.

The **Momentary (M)** Loudness meter measures the loudness of the audio in a **400 ms** period and then updates the Momentary Loudness displays (numeric value, meter and peak).

The **Short-term (S)** Loudness meter measures the maximum level of all short-term loudness values received over a period of **3 s** monitors and then updates the Short-term Loudness displays (numeric value, meter and peak).

The **Integrated (I)** Loudness meter measures the average loudness over the entire length of the monitoring session, audio track or program and then updates the Integrated Loudness displays (numeric value, meter and peak).

The underlying Loudness Engine calculates the Momentary, Short-term and Integrated loudness values and the Loudness meters are the visual representation of the underlying algorithm and calculations.

Each Loudness Meter is color-coded for ease of recognition as follows:

- **Momentary Meter:** **Magenta**
- **Short-term Meter:** **Orange**
- **Integrated Meter:** **Cyan**

The colors of the loudness meters are also reflected in both the numeric loudness values and in the plotted traces in the Loudness History graphs.

When a loudness value for one of the loudness meters is in error, the value is displayed in red.

The configurable **Target Zone** of each meter represents the target loudness of the input audio signal and is displayed as the green background in the meter. When the loudness is within the target range, the numeric value is displayed in the same color as the corresponding meter.

The configurable **Tolerance Zone** of each meter represents the tolerance permitted for the loudness of the signal to be outside the target range and is displayed as the yellow background in the meter. If the tolerance is set to zero (0) or a very low value, you may not see a yellow background section on the meter. When the loudness is within the tolerance range, the numeric value is displayed in the same color as the corresponding meter.

The area of the meter outside the target and tolerance levels represents the loudness Error Zone, or excessive loudness, and is displayed as a red background in the meter.

If the loudness is within the error zone of any of the meters, the corresponding loudness value is displayed in red.

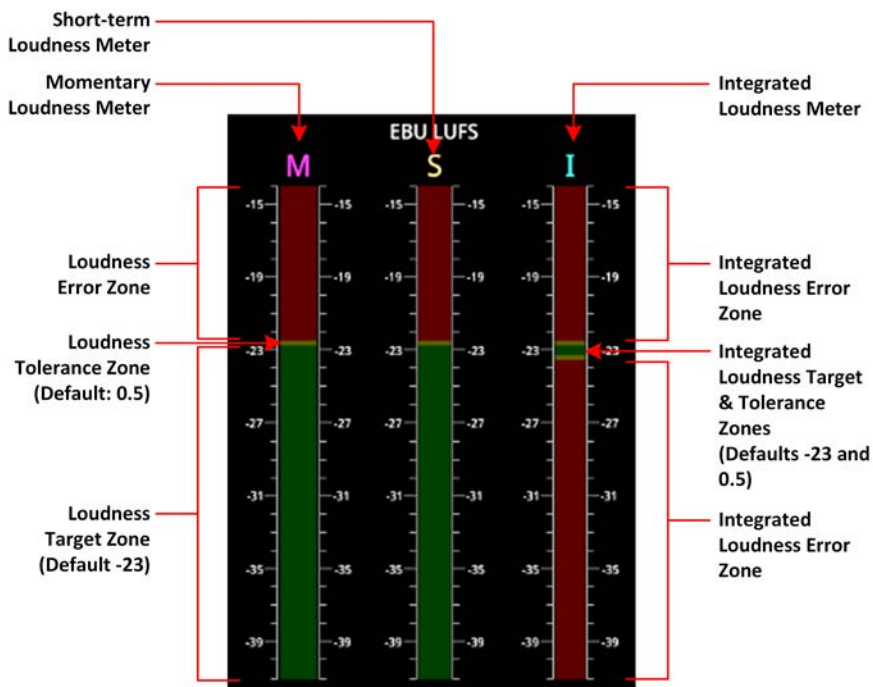

Figure 10-7: EBU LUFS Loudness Meters Showing Default Configuration With No Signal

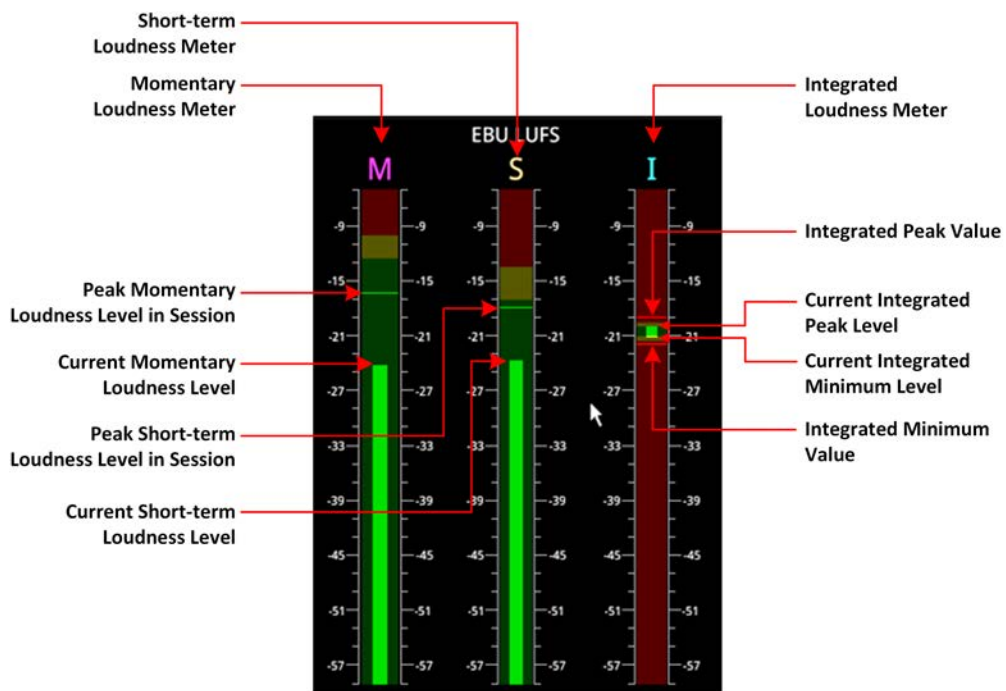

Figure 10-8: Active EBU LUFS Loudness Meters Showing Peak Levels

The unit measures loudness simultaneously, across three different time periods, momentary, short-term and integrated. The current loudness values, displayed to the right of the Loudness meters, are shown in the same color as their corresponding meter, for example, the Momentary Loudness value is magenta, and so on. Only when the value exceeds the configured target and tolerance level does the color of the displayed value change to red to indicate a loudness error condition. Each of the Loudness values is described in the following subsections.

True Peak Value

As specified in the EBU Recommendation EBU-R 128-2020 the True Peak "level of a programme shall not exceed -1dBTP (dBTruePeak) during production (linear audio)." The True Peak measurement is calculated from all audio data for each channel and is not affected by the choice of ballistics.

The True Peak value is displayed in white font when below the value of the configurable True Peak Alarm threshold. When the True Peak value exceeds the True Peak Alarm threshold setting, the True Peak value is displayed in red. You can set the True Peak Alarm threshold anywhere in the range from -99.9 to 0 dBFS, with the default set to 0 dBFS.

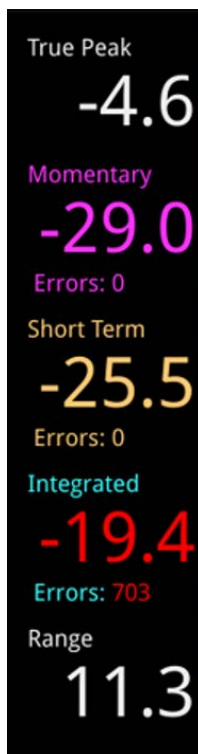

Figure 10-9: Loudness Values Showing Errors on the Integrated Loudness Value

Momentary Loudness Value and Error Count

The Momentary Loudness value, displayed immediately below the True Peak value, represents the loudness value measured across the shortest timescale of 400 ms. The unit updates the value every 100 ms.

If the Momentary Loudness value is above the configured tolerance level then the unit starts to record an error count and the value changes color to red. The error count represents the number of data samples above the target and tolerance threshold.

Short-term Loudness Value and Error Count

The Short-term Loudness value, represents the loudness value measured across a longer timescale of 3 seconds. The unit updates the value every 100 ms.

If the Short-term Loudness value is above the configured tolerance level then the unit starts to record an error count and the value changes color to red. The error count represents the number of data samples above the target and tolerance threshold.

Integrated Loudness Value and Error Count

The Integrated Loudness value represents the average loudness across the entire session or program. The unit updates the value every one second.

If the Integrated value exceeds the tolerance setting, the error counts are recorded, in the same way as for momentary and short term loudness but, in addition, if the value reaches the target then drops below the tolerance, the unit records ten error counts.

Loudness Range Value

The Loudness Range is defined in the EBU Recommendation EBU-R 128-2020 as "*the distribution of loudness within a programme.*" The unit calculates and updates this value every second.

Using the Loudness Controls

The loudness monitoring controls are designed to appear as standard media controls and work in the same way. Use these controls to start, pause, restart and stop the loudness monitoring session. Active controls are displayed as a white icon on a gray background and inactive controls are reversed, as shown in the following graphic.

The following loudness monitoring controls are located below the loudness meters to control the progress of loudness monitoring; from left to right:

- **Stop** - stops the current loudness monitoring and logging session
- **Play** - starts the loudness monitoring and logging session
- **Pause** - pauses the current loudness monitoring and logging session.

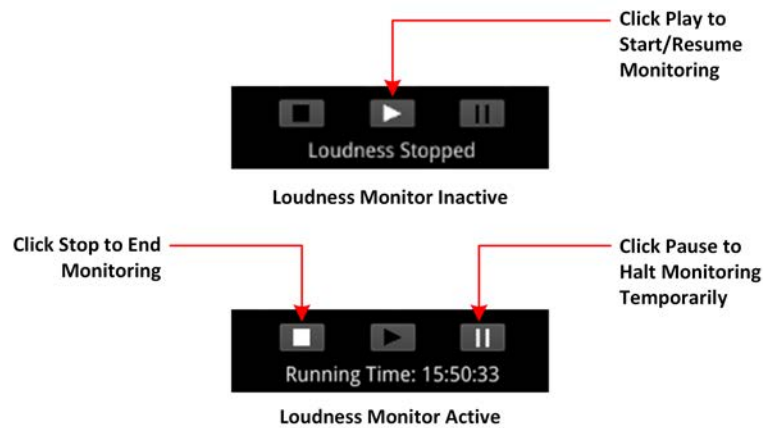

Figure 10-10: Loudness Monitoring Controls

To start a loudness monitoring session, click the **Play** button and to stop the session, click **Stop**. If you want to suspend loudness monitoring temporarily press **Pause**, then either **Play** to resume or **Stop** to end the session.

You will see the current status of a loudness monitoring session displayed below the controls. If monitoring is in progress, the Loudness Monitor displays the running time of the session, in the format **hh:mm:ss**. If monitoring is paused, or stopped, you will see the messages **Loudness Stopped** or **Loudness Paused**, respectively.

Using the Loudness History Graph

The Loudness History Graph displays a trace of loudness values over a configured time period for each active loudness meter, with the trace displayed in the same color as its associated meter. You can set the displayed graphing period from one minute to a maximum of 10 minutes and the horizontal (x-axis) time scale adjusts accordingly. The vertical (y-axis) scale represents the loudness units for the configured standard, for example, LUFS, LKFS, or LU. The scale values adapt automatically to the loudness values being monitored.

If you position the cursor over any point in the History Graph, the unit displays a tooltip containing the following information:

- Current actual time
- Elapsed time in the loudness monitoring session
- Momentary loudness value at that point (if active)
- Short-term loudness value at that point (if active)
- Integrated loudness value at that point (if active)

If you stop loudness monitoring using the loudness controls and then start another session, the content is cleared from the History Graph.



Figure 10-11: Loudness History Graph

Resetting Loudness Values and Errors

The reset controls in the Loudness Options menu enable you to reset the following:

- **True Peak Value:** Resets to the current true peak value at the moment of reset.
- **Loudness Monitoring:** Clears the Loudness History Graph and restarts the loudness monitoring session to commence monitoring again from time zero.
- **Errors:** Zeroes any error counts registered by the Momentary, Short-term or Integrated loudness meters.

Managing the Loudness Log Files

The unit automatically starts to record a loudness log when you click **Play** to start the loudness monitoring session.

The unit creates two files for each loudness log as follows:

- A log description text file with a **.txt** extension
- A data file in comma separated value (CSV) format with a **.csv** extension.

Both log files are compressed into a single zip file when the unit saves the logfile to the repository.

The log description text file contains the following content:

- Start Date
- Start Time
- Loudness Mode (LUFS/LKFS/LU)
- List of loudness inputs
- Target and Tolerance configuration
- End Time
- True Peak levels for each loudness input

- Highest Momentary Loudness value
- Momentary Error Count
- Highest Short-term Loudness value
- Short-term Error Count
- Highest Integrated Loudness Value
- Integrated Error Count
- Final Loudness Range value

The data CSV logfile contains the following content:

- Time
- Timecode
- Momentary Loudness value
- Short-term Loudness value
- Integrated Loudness value
- Loudness Range value

Each time the configured **Log Duration** is reached, or you stop or pause loudness monitoring, the unit saves a Loudness Log to the repository. You can set the Log Duration to a value between five minutes and 24 hours in the Options menu, with a default duration of 30 minutes.

Each loudness logfile is an individual, time-stamped, compressed CSV (comma separated value) zip file, saved in the following folder:

qx:/log/loudness

The Log Lifetime setting is the period that the unit keeps the loudness logs in its repository. You can set the log lifetime period from one to 30 days in the Options menu. Once the configured log lifetime elapses, the unit will delete the loudness logfile.

Retrieving the Loudness Log Files

Use the File Manager to copy the Loudness logfiles to a USB drive, in the same way as with other files. Open the File Manager from the Launch menu or insert a USB drive into one of the USB ports.

From the **qx:/** folder, open the **log** folder, then the **loudness** folder. You should see all your loudness logfiles listed with a date- and time-stamp, together with a **.zip** extension. Select the desired files, right-click, then select **Copy from Qx to USB...** from the dropdown menu.

You can also delete selected logfiles, if necessary.

For more information on the File Manager, see the section ["Managing Files with the USB File Manager" on page 3-19](#).

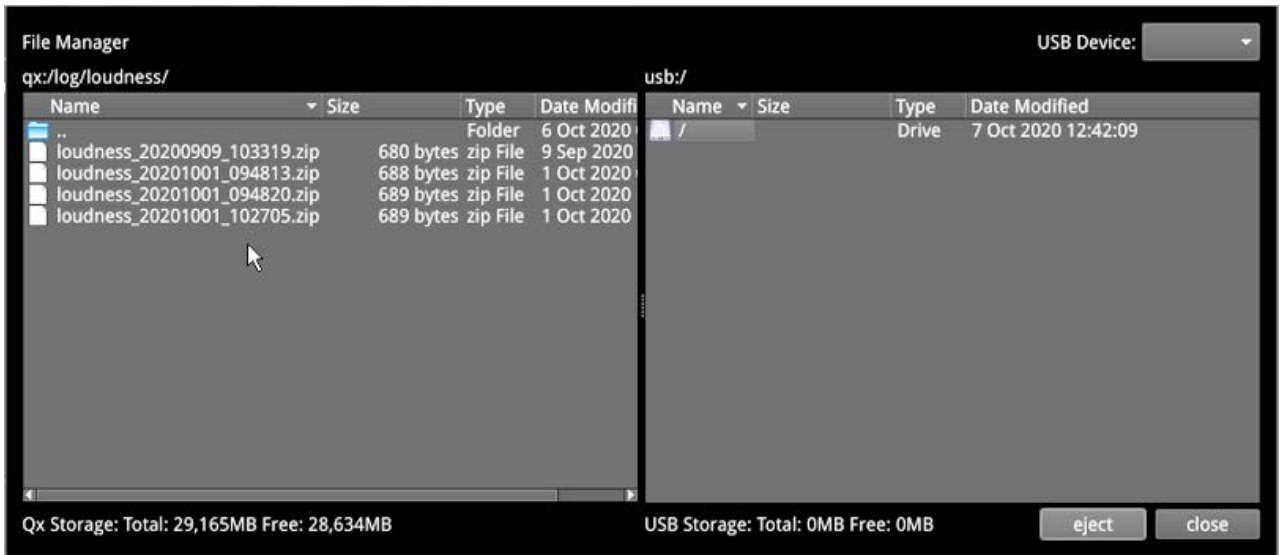

Figure 10-12: Loudness Logfiles Listed in the File Manager

Renaming the Loudness Logfile Base Name

All logfiles are named using the following syntax by default:

loudness_YYYYMMDD_hhmmss.zip



Figure 10-13: Rename Loudness Logfile Base Name

The loudness logs are always date- and time-stamped, however, you can change the default **loudness** base name as required. To do so, select **Rename file...** from the Loudness Options menu to display the rename dialog. Enter a new base name in the field, then click **Ok**. The new base name will be used to name all loudness logfiles from that point forward.

Instrument Menu Options

The following menu options are available for configuring the **Analyzer - Loudness Monitor** Instrument:



Figure 10-14: Analyzer - Loudness Monitor Menu Options

Table 10-3 : Analyzer - Loudness Monitor Menu Options

Item	Options	Description
Audio Assignment	System Control - opens Audio Assignment dialog	Use this control to open the Audio Assignment dialog to select the audio mode and assign the loudness input channels.
Audio Meter Ballistics and Scale Settings		
Ballistics	PPM Type I (Default) PPM Type II Vu VuFr	Set the required peak program meter (PPM) ballistic responsiveness setting for the audio meters. PPM Type I emulates the performance of IEC 60268-10

Item	Options	Description
	Fast	Type I PPM style audio meters typically used by German broadcasters. PPM Type II emulates the performance of IEC 60268-10 Type II PPM style audio meters typically used by UK broadcasters. Vu emulates the performance of IEC 60268-17 Type I PPM style audio meters typically used by US and Australian broadcasters. VuFr emulates the performance of ITU-R Rec BS.645 style audio meters typically used by French broadcasters. Fast provides instantaneous attack ballistics. Note: The Ballistics option is a global setting that applies to all of the unit's audio meters.
PPM Scale Type	dBFS (Default) dBu -18dBFS dBu -20dBFS BBC DIN45406 Nordic N9	Set the desired scale for the loudness audio meters according to your standard operating model. The displayed graticule and audio levels change accordingly to reflect the selected scale. Note: The PPM Scale Type applies only to the audio meters in the Loudness Monitor; the Audio Meters instrument has its own Scale Type setting.
Loudness Settings		
Loudness Standard	EBU LUFS (Default) EBU LU ITU LKFS ITU LU	Select the appropriate loudness standard for loudness monitoring of your audio track or program. You can switch between ITU and EBU standards without losing your customized settings.
Loudness Scale	+9 Scale (Default) +18 Scale	The +9 and +18 scales are defined in EBU Tech 3341-2016 and have been adopted by the ITU. The scale ranges are as follows for EBU: +9 Scale: -18.0 LU to +9.0 LU (-41.0 LUFS to -14.0 LUFS) +18 Scale: -36.0 LU to +18.0 LU (-59.0 LUFS to -5.0 LUFS) The scale ranges are as follows for ITU: +9 Scale: -18.0 LU to +9.0 LU (-42.0 LUFS to -15.0 LUFS) +18 Scale: -36.0 LU to +18.0 LU (-60.0 LUFS to -6.0 LUFS) See Figure 10-15 for a comparison of these scales.
Loudness History Graph Settings		
Graph Period	1 minute(Default) 2 minutes 5 minutes 10 minutes	Define the time period over which the History Graph displays loudness data. The horizontal time scale adjusts automatically to the selected period.
Graph Momentary	Enabled (Default) Disabled	When enabled, the unit plots the Momentary loudness trace in the Loudness History Graph. You can switch off the display of the Momentary loudness trace if desired. You can display the Momentary graph even if the Momentary loudness meter is disabled.

Item	Options	Description
Graph Short Term	Enabled (Default) Disabled	When enabled, the unit plots the Short-term loudness trace in the Loudness History Graph. You can switch off the display of the Short-term loudness trace if desired. You can display the Short-term graph even if the Short-term loudness meter is disabled.
Graph Integrated	Enabled (Default) Disabled	When enabled, the unit plots the Integrated loudness trace in the Loudness History Graph. You can switch off the display of the Integrated loudness trace if desired. You can display the Integrated graph even if the Integrated loudness meter is disabled.
Graph Fixed Period	Enabled (Default) Disabled	When enabled, the x-axis is set to the static value set in the Graph Period option and does not change dynamically. When disabled, the x-axis scale is dynamic up to a maximum period of 2 minutes (120 seconds), after which it is fixed.
Graph Graticules	Disabled (Default) Enabled	When enabled, displays gridlines in the background of the graph.
Loudness Meter Activity		
Momentary Meter	Enabled (Default) Disabled	When disabled, the Loudness Monitor will not display momentary loudness values or errors, however, the data is still recorded in the loudness log.
Short Term Meter	Enabled (Default) Disabled	When disabled, the Loudness Monitor will not display short-term loudness values or errors, however, the data is still recorded in the loudness log.
Integrated Meter	Enabled (Default) Disabled	When disabled, the Loudness Monitor will not display integrated loudness values or errors, however, the data is still recorded in the loudness log.
Loudness Targets, Tolerances and Alarm		
Momentary Target	Range: -41 to -14 Default: -23	Set the maximum acceptable Momentary loudness level for the monitored track or program. This represents the green section of the meter and signal.
Momentary Tolerance	Range: 0.0 to 10.0 Default: 0.5	When set to a value above 0.0, the Momentary tolerance is displayed as the yellow background of the Momentary Loudness meter. When the monitored momentary loudness is within the tolerance, the level color changes to yellow. A tolerance level provides an acceptable buffer to accommodate for measurement errors. If the Momentary tolerance is set to 0.0 then the tolerance / target feature is disabled so that the meter background is completely green and no errors are displayed.
Short Term Target	Range: -41 to -14 Default: -23	Set the maximum acceptable Short-term loudness level for the monitored track or program. This represents the green section of the meter and signal.
Short Term Tolerance	Range: 0.0 to 10.0 Default: 0.5	When set to a value above 0.0, the Short-term tolerance is displayed as the yellow background of the

Item	Options	Description
		Short-term Loudness meter. When the monitored short-term loudness is within the tolerance, the level color changes to yellow. A tolerance level provides an acceptable buffer to accommodate for measurement errors. If the Short-term tolerance is set to 0.0 then the tolerance / target feature is disabled so that the meter background is completely green and no errors are displayed.
Integrated Target	Range: – 41 to –14 Default: –23	Set the maximum acceptable Integrated loudness level for the monitored track or program. This represents the green section of the meter and signal.
Integrated Tolerance	Range: 0.0 to 10.0 Default: 0.5	When set to a value above 0.0, the Integrated tolerance is displayed as the yellow background of the Integrated Loudness meter. When the monitored integrated loudness is within the tolerance, the level color changes to yellow. A tolerance level provides an acceptable buffer to accommodate for measurement errors.
True Peak Alarm	Range: 0 to –99 Default: 0	Set the threshold above which the unit generates errors for the loudness True Peak.
Reset Controls		
Reset True Peak Value	System Control	Resets to the current True Peak value at the moment of reset.
Reset Loudness Monitoring	System Control	Resets both the Loudness History Graph and the loudness logs. The loudness monitoring session restarts from time zero.
Reset Errors	System Control	Resets all error counts from the active loudness meters to zero. This control does not reset the loudness logs.
Loudness Log Settings		
Log Duration	5 minutes 15 minutes 30 minutes (Default) 1 hour 2 hours 3 hours 6 hours 12 hours 24 hours	Set the duration of each loudness logfile. When the Log Duration is met during a monitoring session, the unit saves the logfile to the repository with the current date- and time-stamp.
Log Lifetime	1 day 7 days (Default) 14 days 30 days	Set the retention period for loudness logfiles in the unit's repository. On expiry of the Log Lifetime period, the unit deletes the logfile to free-up space in the repository.
Rename File...	System Control - Opens file renaming dialog	Use this control to change the loudness logfile base-name from loudness to a different string.

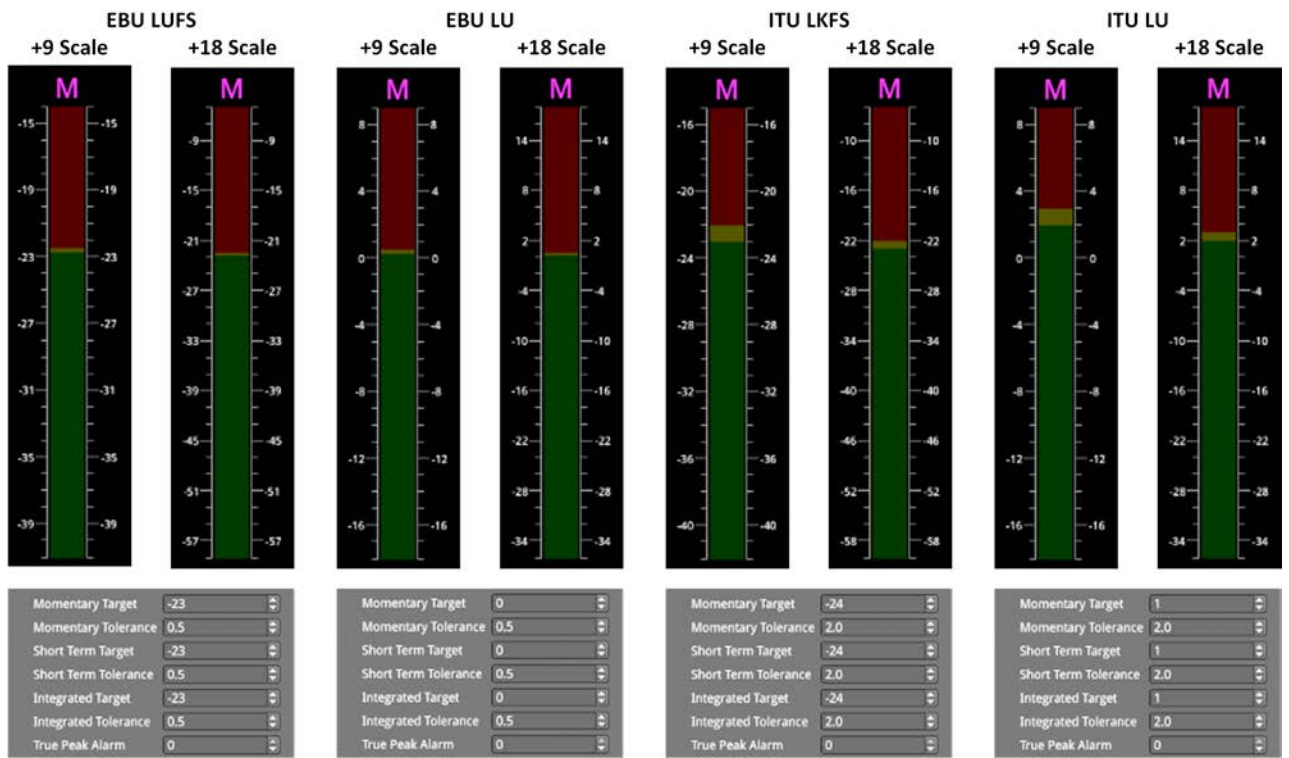

Figure 10-15: Loudness Standard Scales for Momentary Meter & Default Target/Tolerance Settings for All Meters

Data Analysis Instruments

Note: Requires the **PHQXO-DATA** License.

This chapter describes the suite of data analysis Instruments and includes the following sections:

- [Analyzer - Dataview](#)
- [Analyzer - Ancillary Status](#)
- [Analyzer - Ancillary Inspector](#)



Requires Option(s):	PHQXO-DATA
---------------------	------------

Overview

The **Analyzer - Dataview** instrument displays the raw data present in the signal, be it - 1.5G HD-SDI, 3G-SDI, 6G-SDI, 12G-SDI, 2022-6 or 2110. The data can be observed in hexadecimal, decimal, or binary formats, and each data word has a sample and line coordinate. The instrument displays the entire video frame complete with active video, TRS words, and blanking information. Changing the window size changes the amount of data displayed. For 6G-SDI and 12G-SDI video standards, pre-imposed sync bit correction is provided.

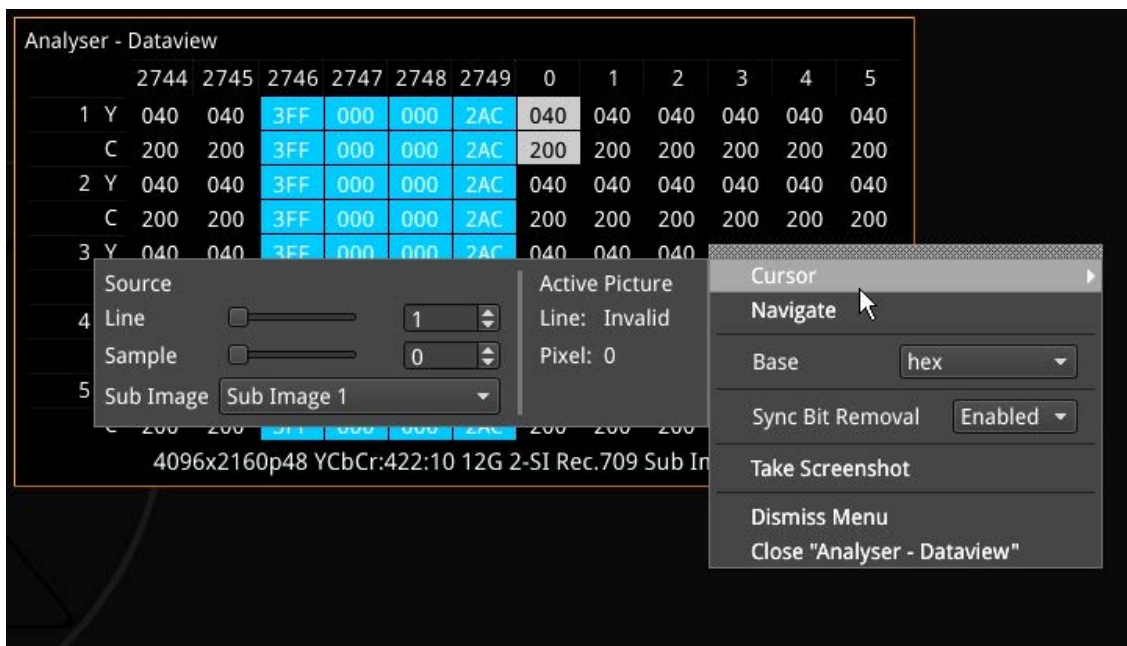

Figure 11-1: Analyzer - Dataview Instrument

Data is presented with a color-coding for both text and background:

- Foreground color indicates video sample type: Y (white), Cb (blue), Cr (red)
- Background color indicates data type: TRS words (blue), Blanking (black), Active picture (green)

You can quickly navigate the dataview window using sample and line selection in the Cursor tool or using the Navigate keypad (shown, right).

Both tools are dynamically linked to an enabled Picture Cursor in the Waveform and Picture instruments.

The Cursor tool provides transport line and sample sliders to move around the dataview, at the same time as giving the corresponding Active Picture line and pixel values.

The Navigate keypad allows you to enter the desired coordinates, and provides buttons for quick navigation to key locations: first and last samples or lines, end of active video (EAV) and start of active video (SAV) TRS words, active picture (AP) furthest - left, right, top, and bottom positions.

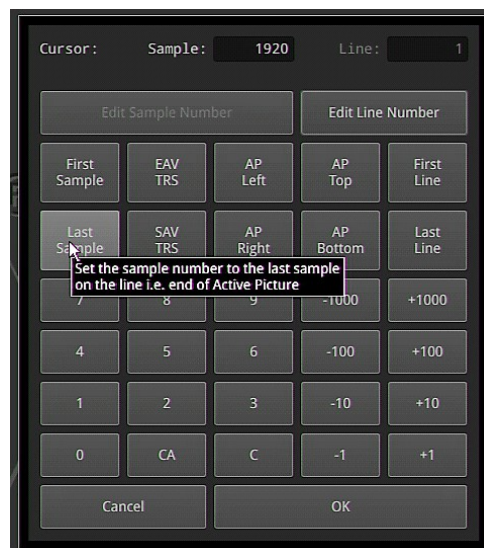

Figure 11-2: Dataview Navigate Keypad

Instrument Menu Options

The following right-click submenu options are available:

- Cursor > Source > Line > [1 to Total number of Lines for current standard]
- Cursor > Source > Sample > [1 to Total number of Lines for current standard]
- Cursor > Source > Sub Image > [Sub Image 1, Sub Image 2, Sub Image 3, Sub Image 4] (standard dependent)
- Navigate > [calls up navigation keypad]
- Base > [hex, decimal, binary]

For 6G-SDI and 12G-SDI video standards the option is provided, to view the data stream before sync bit removal or after sync bit removal.

- Sync Bit Removal > [Enabled, Disabled]

Enabling Sync Bit Removal reverts affected bits to the original value they held prior to sync bit insertion. You can observe this reversion in the TRS and ADF words.

Note: This feature applies only to 6G-SDI and 12G-SDI video standards, where the inclusion of a sync bit is defined in the SMPTE standards. Signals not containing sync bits are unaffected.



Overview

The **Analyzer - Ancillary Status** instrument provides a sophisticated, real-time display which analyzes the ancillary data present in the signal. UHDTV has a new set of rules for carrying this data and a clear graphical representation is required to establish compliance. Color-coded signal conditions - present, lost, and error are all available. Additional data is displayed as you resize the instrument.

In addition to the option of a combined view, tabs are provided for separate Grid or List views of the ancillary data.

Ancillary Status - Grid		List View	
S353 MPEG Recoding	S305 SDTI	S348 HD-SDTI	S427 Link Encryption
S352 Payload ID	S2016-3 AFD	S2016-4 PAN	S2010 ANSI/SCTE
S2031 DVB/SCTE	S2056 MPEG TS	S2068 3D Packing	S2064 Lip Sync
ITU-R BT.1685	OP47 Caption	OP47 VBI/WST	ARIB-TR-B29
RDD18 Metadata	RP214 KLV Metadata	RP223 UMID/ID	S2020 Audio
S2051 Two Frame	RDD8 WSS	RP215 Film Codes	S12M-2 V-TCODE
EIA-708 Caption	EIA-608 Caption	RP207 Program	S334-1 Data
RP208 VBI Data	Mark Deleted	S299-2 3G Audio	S299-1 HD Audio
S272 SD Audio	S315 Camera Pos	RP165 EDH	S12-3 HFR TCODE
S2103 Generic Time	S2108-1 HDR/WCG		

Figure 11-3: Analyzer - Ancillary Status

The Grid view provides a high-level overview of the packets present in the ancillary data.

In the List View tab, you can expand the headings, to allow a granular drill-down of discovered ancillary packets – providing information on presence, checksum, parity, and data block number (DBN). You can select packets in this window for analysis by the **Analyzer – Ancillary Inspector**.

Color-coding of displayed data provides further health information at a glance:

- White - Indicates ANC packets present and correct
- Red - Indicates ANC packets present but in error
- Yellow - indicates ANC packets present and correct but there has been a previous error.

Instrument Menu Options

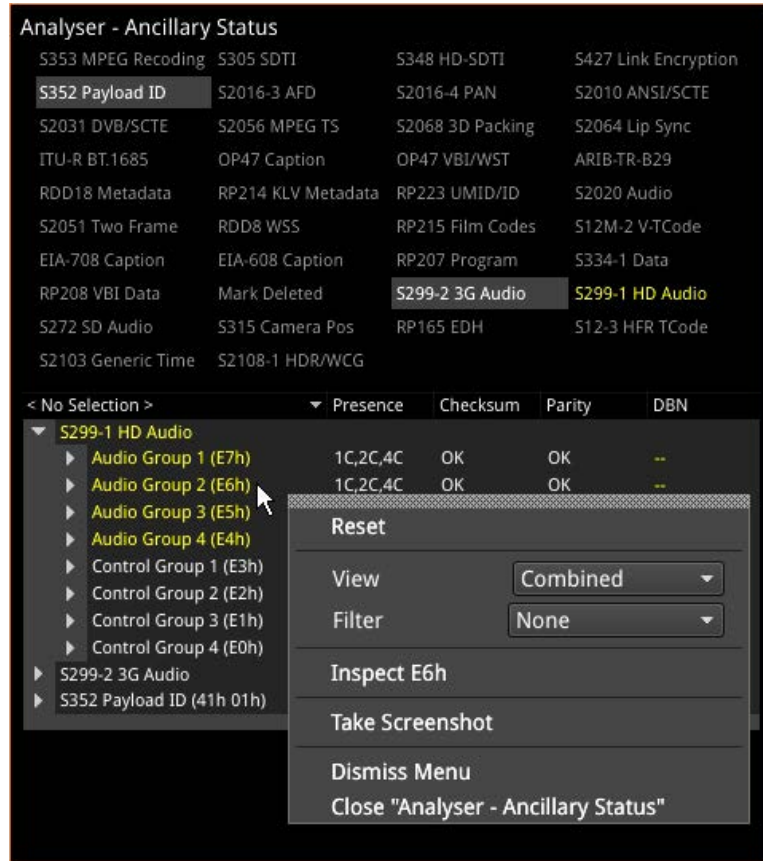

Figure 11-4: Analyser - Ancillary Status Menu Options

From the **Analyser - Ancillary Status** instrument submenu, accessible in all views, you can reset the ancillary status analysis, inspect selected packets and set configuration options as follows:

Table 11-1: Analyser - Ancillary Status Menu Options

Item	Options	Description
Reset	N/A	Select to reset ancillary status analysis (accessible in all views).
View	Tab View Combined	The combined view provides both a high-level overview grid at the top and an expandable list view below, all in a single window, as shown in the following screen:
Filter	None Ancillary Packet Type	Change the ancillary packet type being filtered by simply selecting a different packet type from the Grid. See the following table for a list of available ancillary data identifiers.
Inspect	Selected packets in Analyzer.	Note: If a packet type is not selected in the List view, the Inspect... option will be unavailable. Enables you to select packets from the list and then initiate ancillary inspection, see for a list of ancillary data IDs. For more information on ANC inspection, see the section "Analyzer - Ancillary Inspector" on page 11-8 . Select Inspect... to send the inspection request over to the Analyser - Ancillary Inspector Instrument. If the

Item	Options	Description
		<p>Analyzer - Ancillary Inspector is not currently open, the request opens the instrument. The inspection request is loaded into the Identifier field of the Inspector instrument and, depending on the trigger setting, reacts as follows:</p> <p>None - the request is loaded, but not acted upon</p> <p>Single Shot - the ANC Inspector searches for the packet type and displays the result once a matching packet is detected. (The trigger is then set back to None.)</p> <p>Continuous - the ANC Inspector continuously searches for the selected packet type and refreshes the displayed results each time it detects a matching packet type.</p>

Table 11-2 : List of Ancillary Status Grid Identifiers

Ancillary Status Grid Identifier	Description
S353 MPEG Recoding	MPEG-2 Recoding Information
S305 SDTI	SDTI transport in active frame space
S348 HD SDTI	HD-SDTI Transport in active frame space
S427 Link Encryption	Link encryption for 1.5 Gb/s Serial Digital Interface
S352 Payload ID	Payload identification, HANC space
S4S2016-3 AFD	AFD and Bar data
S2016-4 PAN	Pan-scan data
S2010 ANSI/SCTE	ANSI/SCTE 104 messages
S2031 DVB/SCTE	DVB/SCTE VBI data
S2056 MPEG TS	MPEG TS packets in VANC
S2068 3D Packing	Stereoscopic 3D frame compatible packing and signaling
S2064 Lip Sync	Lip sync data as specified by ST 2064-1 or ST 2064-2
ITU-RBT.1685	Structure of inter-station control data conveyed by ancillary data packets
OP47 Caption	OP47/RDD8 Subtitling distribution packet (SDP)
OP47 VBI/WST	OP47/RDD8 Transport of VBI and/or WST data in a VANC Multipacket
ARIB-TR-B29	Metadata to monitor errors of audio and video signals on a broadcasting chain
RDD18 Metadata	Acquisition metadata sets for video camera parameters
RP214 KLV Metadata	KLV encoded metadata transport
RP223 UMID/ID	Packing UMID and Program Identification Label data into SMPTE 291M Ancillary Data Packets
S2020 Audio	Compressed audio metadata
S2051 Two Frame	Two frame marker in HANC
RDD8 WSS	Wide-screen signalling data
RP215 Film Codes	Film codes in VANC space

Ancillary Status Grid Identifier	Description
S12M-2 V-TCode	Ancillary time code
EIA-708 Caption	S334-1 EIA 708B Data mapping into VANC space
EIA-608 Caption	S334-1 EIA 608 Data mapping into VANC space
RP207 Program	Program description in VANC space
S334-1 Data	Data broadcast (DTV) in VANC space
RP208 VBI Data	VBI data in VANC space
Mark Deleted	S291 - Packet marked for deletion
S299-2 3G Audio	Audio data in HANC space (3G)
S299-1 HD Audio	Audio data in HANC space (HDTV)
S272 SD Audio	Audio data in HANC space (SDTV)
S315 Camera Pos	Vamera position (HANC or VANC space)
RP165 EDH	Error detection and handling (HANC space)
S12-3 HFR TCode	Time code for high frame rate signals
S2103 Generic Time	Generic time label
S2108-1 HDR/WCG	Extended HDR/WCG

For tooltips on each of the Status Grid Identifiers, hover the mouse cursor over the identifier.

Analyzer - Ancillary Inspector



Requires Option(s):	PHQXO-DATA
---------------------	------------

Overview

The **Ancillary (ANC) Inspector** monitors the analyzed signal and displays the contents of selected Ancillary packets in the received data.

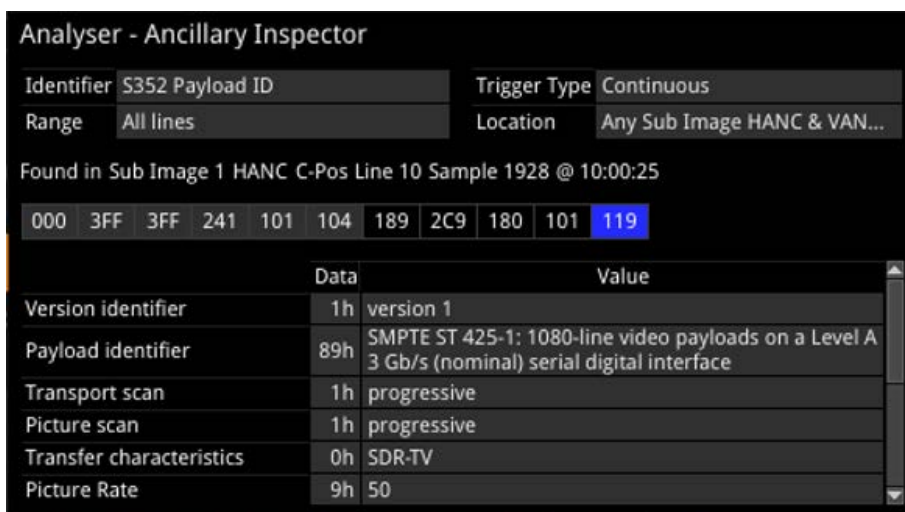

Figure 11-5: Analyzer - Ancillary Inspector Instrument

The window displays both the location of the found packet and the time at which it was found.

The lower part of the window displays the packet in hexadecimal form including individual header words (gray background), data words (black background), and checksum (blue background). Hover the mouse over each header word to reveal more detail.

Instrument Menu Options

The following menu options are available for configuring the **Analyzer - Ancillary Inspector** Instrument:

Table 11-3 : Analyzer - Ancillary Inspector Menu Options

Item	Options	Description
Identifier	None Ancillary Packet Type	Set the Identifier parameter to the ancillary packet type you want to find. For a list of ancillary data identifiers, see the section "Analyzer - Ancillary Status" on page 11-4.
Trigger	None Single Shot Continuous	Set Triggers so that when ancillary data exactly matching the search parameter(s) is detected, the ANC Inspector triggers and displays the inspection result in the lower part of the window. After detecting a matching packet, when the Trigger is set to Single Shot , the inspection result remains in the results display area and the trigger state reverts to None . If the Trigger is set to Continuous , it will remain in the current state after successful detection, and will continuously cause the display to refresh with the results of the next successful detection.

Item	Options	Description
Sub Image	Any Sub Image 1 Sub Image 2 Sub Image 3 Sub Image 4 Sub Ima... Link B Sub Ima... Link B Sub Ima... Link B Sub Ima... Link B	Additional ANC inspection parameter to use in the data search.
Lines	Any Inside Range Outside Range	Additional ANC inspection parameter to use in the data search.
HANC/VANC	Both HANC VANC	Additional ANC inspection parameter to use in the data search.
Y-Pos/C-Pos	Both Y-Pos C-Pos	Additional ANC inspection parameter to use in the data search.
Trigger only on Errors	Enabled Disabled	When enabled, you can select to enable or disable any of the following: Checksum Errors DBN Errors Parity Errors ANC Gap Errors

You can set the **Identifier** parameter in the submenu of the ANC Inspector to search for the ancillary packet type you want to find.

- **Identifier** > Select from the following available Identifiers:

Table 11-4 : List of Available Ancillary Data Identifiers

Any	Custom	S353 MPEG Recoding VANC Space	S353 MPEG Recoding HANC Space	S305 SDTI
S348 HD-SDTI	S427 Link Encryption Message 1	S427 Link Encryption Message 2	S427 Link Encryption Metadata	S352 Payload ID
S2016-3 AFD	S2016-4 PAN	S2010 ANSI/SCTE	S2031 DVB/SCTE	S2056 MPEG TS
S2068 3D Packing, S2064 Lip Sync	S2108-1 HDR/WCG	ITU-R BT.1685	OP47 Caption	OP47 VBI/WST
ARIB-TR-B29	RDD18 Metadata	RP214 KLV Metadata VANC Space	RP214 KLV Metadata HANC Space	RP223 UMID/ID
S2020 Audio Channel Pair 1/2	S2020 Audio Channel Pair 3/4	S2020 Audio Channel Pair 5/6	S2020 Audio Channel Pair 7/8	S2020 Audio Channel Pair 9/10
S2020 Audio Channel Pair 11/12	S2020 Audio Channel Pair 13/14	S2020 Audio Channel Pair 15/16	S2051 Two Frame	RDD8 WSS
S12M-2 V-TCODE	S2103 Generic Time	EIA-708 Caption	EIA-608 Caption	S12-3 HFR TCODE
RP207 Program	S334-1 Data	RP208 VBI Data	Mark Deleted	S299-2 3G Audio Control Group 8
S299-2 3G Audio Control Group 7	S299-2 3G Audio Control Group 6	S299-2 3G Audio Control Group 5	S299-2 3G Audio Audio Group 8	S299-2 3G Audio Audio Group 7
S299-2 3G Audio Audio Group 6	S299-2 3G Audio Audio Group 5	S299-1 HD Audio Control Group 4	S299-1 HD Audio Control Group 3	S299-1 HD Audio Control Group 2
S299-1 HD Audio Control	S299-1 HD Audio Audio	S299-1 HD Audio Audio	S299-1 HD Audio Audio	S299-1 HD Audio Audio

Group 1	Group 4	Group 3	Group 2	Group 1
S272 SD Audio Control Group 4	S272 SD Audio Control Group 3	S272 SD Audio Control Group 2	S272 SD Audio Control Group 1	S315 Camera Pos
RP165 EDH	S272 SD Audio Group 4 Ext	S272 SD Audio Audio Group 4	S272 SD Audio Group 3 Ext	S272 SD Audio Audio Group 3
S272 SD Audio Group 2 Ext	S272 SD Audio Audio Group 2	S272 SD Audio Group 1 Ext	S272 SD Audio Audio Group 1	

When setting any parameters in ANC Inspector, AND logic applies; so note that *all* active search parameters must be met before ANC Inspector can successfully display the results of that search. If ancillary packet data in the analyzed SDI data does not meet even one of the search conditions set, it will not be displayed.

In searching for specific data events it is recommended to keep the search parameters as wide as possible first to establish that you are actually seeing data for the selected ANC packet. Only when the ANC Inspector is displaying streaming data, should you introduce more specific search parameters.

ANC Inspector can also be used to search more generally for errors with **Trigger only on Errors** enabled (and Identifier set to Any). Where an error is present in a packet, individual data word text will become red in the display indicating the exact position of an error within a packet.

IP Network Traffic Measurement

Note: Requires the **PHQXO-IP-MEAS** License.

This chapter describes the advanced IP network traffic measurement instruments available with the IP Measurement option and includes the following sections:

- [IP Receive - Interpacket Timing](#)
- [Analyzer - 2110-21 Status \(IP ST 2110 Mode\)](#)
- [Advanced Media Timing Measurement \(IP 2110\)](#)

IP Receive - Interpacket Timing



Requires Option(s):	PHQXO-IP-NGT (for 2022-6 only) and either: PHQXO-IP-STND (Single Timing Window) or PHQXO-IP-MEAS (Up to Four Timing Windows)
---------------------	--

Overview

Each **IP Receive - Interpacket Timing** window displays the interpacket arrival timings, in each second, for a single flow.

The number of simultaneously available Interpacket Timing windows depends on the selected mode of the unit as follows:

- **IP 2022-6 Mode:** Only one Interpacket Timing window is available.
- **IP 2110 Mode:** Up to four Interpacket Timing windows are available to track the number of simultaneous IP flows that can be selected. You can switch each window between the available flows by selecting from the dropdown list in the Instrument submenu.

The Instrument provides analysis of the IP media flow packet reception, and gives a real-time indication as to the health of the received media flow.

The histogram displays the distribution of all packet arrival intervals, for the selected flow, within a given second, together with the mean, minimum, and maximum packet intervals for this period. Outlier times, significantly longer than the expected mean, may indicate significant delays in packet propagation, or may be indicative of a gapped linear video sender. A high occurrence of such long intervals is characteristic of high jitter in a network.

Features of the Interpacket Timing window include:

- Stream health reporting using a histogram to visualize the distribution of interpacket arrival times (with dynamic auto scaling provided)
- Packet counts (log or linear scales) mapped against arrival times (μ s)
- Easy diagnosis of congestion with maximum, mean and minimum interpacket arrival times
- Zoom capability (and linear Y-axis scale) for closer inspection of narrow distribution regions.
- Mouse controls to center, select range, and reset range as follows:
 - Single left-click to center on the mouse position without zooming. This can be used to pan left and right through the histogram.
 - Click and drag to zoom in on the highlighted range.
 - Single click of the middle mouse button to reset the scale. This reverts the scale to a range where it shows all the data based on the current Min and Max values. You can also reset the scale using the instrument submenu.

Interpacket Timing in IP 2022-6 Mode

In IP 2022-6 mode, you can select a single video flow. The interpacket timing window displays the arrival time of packets, sampled over one second, where a packet contains video, audio and ancillary data.

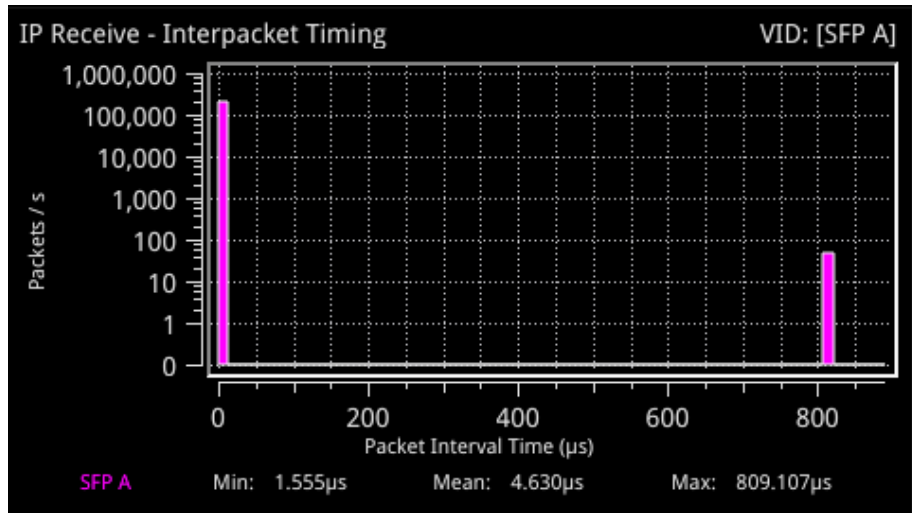

Figure 12-1: IP Receive - Interpacket Timing Instrument

IP 2022-6 Instrument Menu Options

The menu options available in IP 2022-6 mode are as follows:

Table 12-1: IP Receive - Interpacket Timing Menu Options (IP 2022-6 Mode)

Item	Options	Description
Flow	VID: [SFP A]	This is the only flow that can be selected in IP 2022-6 mode.
Y-Axis Scale	Log10 (Default) Linear	Select whether to plot the number of received packets on the vertical (Y) axis using either a logarithmic or linear scale.
Scaling	Auto (Default) Manual	Select how to control the histogram plot scaling. When using the zoom features, the Scaling setting will default to Manual mode. When Manual scaling is selected, you can reset by clicking the Reset Scale option, which becomes available.

Interpacket Timing in IP 2110 Mode

In IP 2110 mode, one video flow, two audio flows, and a single ancillary flow are available for selection. The Interpacket Arrival Time windows can be set to display the interpacket timing histograms of the flows on either SFP A, SFP B or SFP A + B with the two sets of histograms overlaid on top of each other. The following screen shows the interpacket timing for the flows on SFP B.

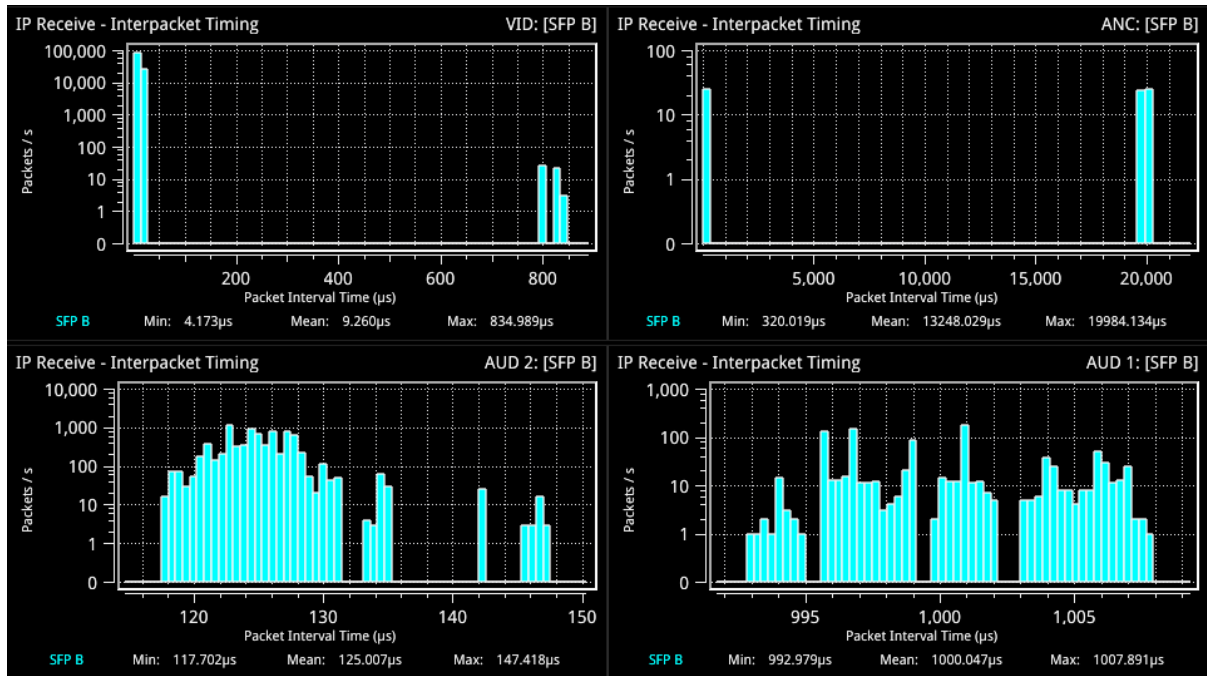

Figure 12-2: IP Receive - Interpacket Timing in IP ST 2110 Mode

When SFP A and B histograms are displayed together, as shown in the following screen, the unit uses SMPTE ST 2022-7 Seamless IP Protection Switching (SIPS) to reconstruct error free Video, Audio and ANC from the flows on both SFP A and SFP B.

- SFP A histograms are colored pink
- SFP B histograms are colored blue
- SFP A + B overlaid histograms are colored purple where they overlap.

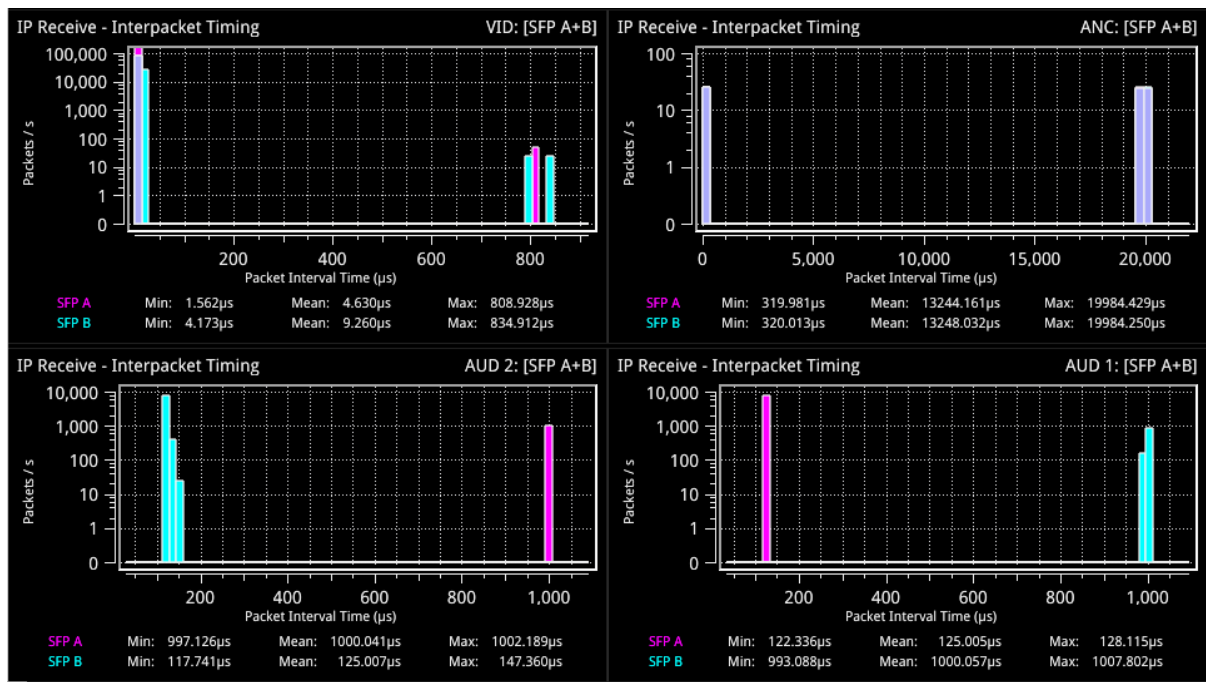

Figure 12-3: IP Receive - Interpacket Timing Using SMPTE ST 2022-7 SIPS on Both SFP A and B

Note: The control for selecting SFP A, SFP B or SFP A + B (Seamless A + B) is available from the dropdown menu of the parameter **2022-7 Mode Selection** in the **IP Receive – Flow Select** Instrument submenu.

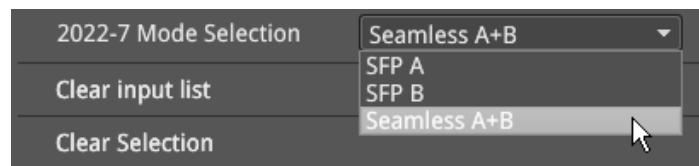

Figure 12-4: SMPTE ST 2022-7 Mode Selection of Seamless A+B

- Select **Seamless A+B** for **2022-7 Mode Selection** to make a single flow, reconstructed from the flows selected on both SFP interfaces, available for analysis
- Select **SFP A** to make only SFP A flows available for analysis
- Select **SFP B** to make only SFP B flows available for analysis.

For more information, see the section ["IP Receive - Flow Select" on page 5-28](#).

IP 2110 Instrument Menu Options

The following shows the options available in the Instrument submenu:

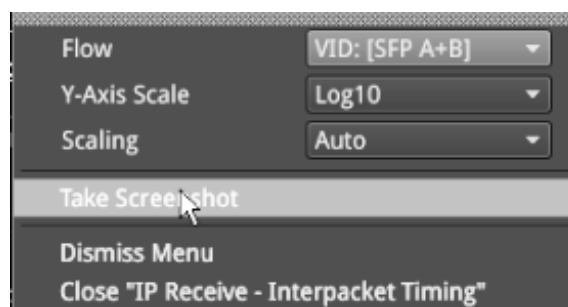

Figure 12-5: IP Receive - Interpacket Timing Menu Options

The menu options available in IP 2110 mode are as follows:

Table 12-2 : IP Receive - Interpacket Timing Menu Options (IP 2110 Mode)

Item	Options	Description
Flow	VID: [SFP A], AUD 1: [SFP A], AUD 2: [SFP A], ANC: [SFP A] VID: [SFP B], AUD 1: [SFP B], AUD 2: [SFP B], ANC: [SFP B] VID: [SFP A+B], AUD 1: [SFP A+B], AUD 2: [SFP A+B], ANC: [SFP A+B]	Select a flow to display in the active window. Note: Available flows are dependent on the option selected in 2022-7 Mode Selection of the IP Receive – Flow Select Instrument.
Y-Axis Scale	Log10 (Default) Linear	Select whether to plot the number of received packets on the vertical (Y) axis using either a logarithmic or linear scale.
Scaling	Auto (Default) Manual	Select how to control the histogram plot scaling. When using the zoom features, the Scaling setting will default to Manual mode. When Manual scaling is selected, you can reset by clicking the Reset Scale option, which becomes available.

Analyzer - 2110-21 Status (IP ST 2110 Mode)

Requires Option(s):	PHQXO-IP-STND and PHQXO-IP-MEAS
---------------------	---------------------------------

Overview

The **2110-21 Status** instrument performs real-time measurements of the parameters constituting the Transmission Traffic Shaping *Leaky Bucket* Models as defined in SMPTE ST 2110-21:2017. The standard describes the following two models:

- Network Compatibility Model (C_{Max})
- Virtual Receiver Buffer Model (VRX_{Full})

Use these measurements to determine whether a sender or transmitter meets the requirements to be defined as one of the following types:

- Narrow: Type **N** (gapped)
- Narrow Linear: Type **NL**
- Wide: Type **W**

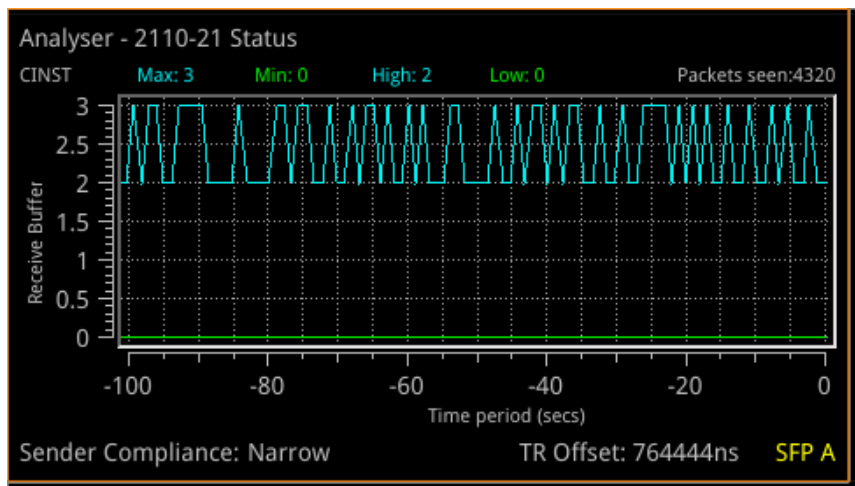

Figure 12-6: Analyzer - 2110-21 Status Instrument

A hardware-based sender will typically be able to establish a carefully controlled read schedule of packets with low levels of packet jitter and highly accurate RTP timestamps and would typically, therefore, be classified as a **Narrow Sender**. A software-based sender, without any hardware assistance, would typically struggle to achieve the same level of control as a hardware-based device and may, consequently, be classified as a **Wide Sender**.

This is an important parameter for a receiving device, as a device with a small buffer (with low latency) may only be capable of handling flows from a Narrow Sender, and is defined as a **Narrow Receiver**. A receiver that can accept flows from both Narrow and Wide Senders will have a larger buffer (with larger latency) and is defined as a **Wide Receiver**. The unit is a Wide Receiver.

The compatibility of the unit is as follows:

Table 12-3 : IP ST 2110-21 Status Compatibility

Sender	Receiver	Unit Compatible ?
Narrow (Gapped or Linear)	Narrow	Yes
	Wide	Yes
Wide	Narrow	No
	Wide	Yes

Note: The ST 2110-21 specification is a direct measure of the Sender without any intervening network, which will typically introduces packet jitter. Practical measurements made with a switch or router in circuit may not be a true measure of the source. You can use this measurement, however, to establish whether a source, in conjunction with a real network, requires a Narrow or Wide Receiver; a consideration which may be useful in low-latency applications.

The thresholds for the maximum values of C_{Full} and VRX_{Full} for Narrow and Wide Senders varies with video format and bit depth. A sender must satisfy both criteria, for example:

Table 12-4 : Narrow and Wide Sender Thresholds for Max C_{Full} and VRX_{Full} by Video Format

V	H	T	Color	Bit	C_{Max}^N	C_{Max}^W	VRX_{Full}^N	VRX_{Full}^W
1280	720	50	4:2:2	10	4	16	8	720
1280	720	60	4:2:2	10	4	16	8	720
1920	1080	25	4:2:2	10	4	16	8	720
1920	1080	50	4:2:2	10	4	16	8	720
1920	1080	60	4:2:2	10	5	16	8	726
1920	1080	50	4:2:2	12	5	16	8	726
1920	1080	60	4:2:2	12	5	16	8	726

Note: Minimum reported values represent the value of the *gap* in a gapped flow as the 2110-21 Status measurements are not windowed.

Measurements and Instrument Menu Options

Measurement Prechecks

Before starting any measurements ensure that the video format parameters entered in the **Analyzer - 2110 Format Setup** Instrument match the video format of the sender.

Network Compatibility Model Measurement (C_{Inst})

The **Analyzer - 2110-21 Status** submenu for the C_{Inst} parameter contains the following options:

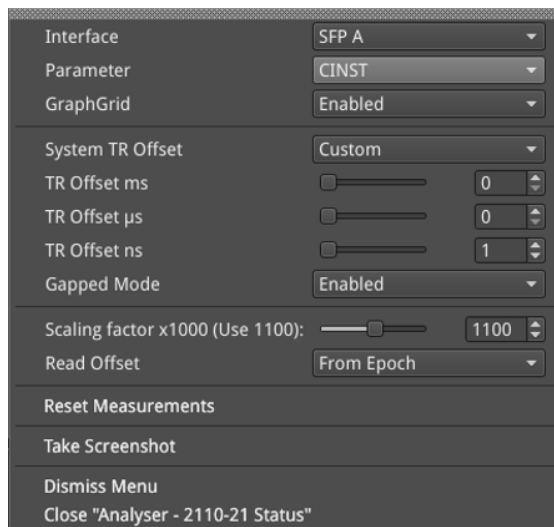

Figure 12-7: Analyzer - 2110-21 Status Menu Options for the C_{INST} Parameter

The **C_{INST}** measurement represents the instantaneous number of packets in the *leaky-bucket* buffer model, averaged over one (1) second.

This measurement is performed with a drain rate (beta) of 1.1, that is, the measurement buffer is being drained 1.1 times faster than it is being filled. The residue of packets in the buffer model is, therefore, an indication of the peak rate at which packets were being delivered into the buffer by the sender.

The menu options available for the **C_{INST}** measurement are as follows:

Table 12-5 : Analyzer - 2110-21 Status - C_{INST} Measurement Options

Item	Options	Description
Interface	SFP A SFP B	Select the target interface for the Analyzer - 2110-21 instrument. When analyzing 2022-7 flows, you switch between SFP A and SFP B.
Parameter	C _{INST} VRX	Select the target measurement for the Analyzer - 2110-21 Status Instrument.
GraphGrid	Enabled (Default) Disabled	When enabled, displays a graphical grid pattern in the instrument background.
System TR Offset	TRO Default (Default) Custom	Defines the timing reference offset (TR Offset) setting. The TR Offset is either a default value based on the current video standard (TRO Default) or a value defined by the sender to account for network delay. Select whether to use the default (TRO Default) as the time at which the read schedule begins on each frame, or select Custom to override the default with a manual TR Offset by adjusting the TR Offset sliders described below to set the granularity in ms, μs and ns. The read schedule must be set to match that of a Gapped or Linear source, see the Gapped Mode option below.
TR Offset Slider Controls	ms, μs, ns	Adjust the slider controls to compensate for the source Video Timing (TR Offset) to obtain an accurate and consistent measurement of C_{INST} .
TR Offset ms	0 to 9	Set the timing reference offset in milliseconds (ms).
TR Offset μs	0 to 999	Set the timing reference offset in microseconds (μs).
TR Offset ns	0 to 999	Set the timing reference offset in nanoseconds (ns).

Item	Options	Description
Gapped Mode	Enabled Disabled	For a Gapped source, ensure that you enable the option Gapped Mode .
Scaling factor x1000 (Use 1100)	100 to 2000	Use the Scaling factor control to change the drain rate presented as 1000 x the drain rate. The default setting is 1100 (x 1.1). If you reduce the scaling factor to 1000, then the drain rate becomes equal to the write rate (x 1.0) and the value of C_{INST} represents the size of the buffer.
Read Offset	From Epoch (Default) Toward Epoch	Enables you to set the custom offset relative to the Epoch time, where the Epoch is 00:00:00 UTC on 01 January 1970.
Reset Measurements	System control	Use this control to reset the measurement to the start.

Note: It is possible to make this measurement if the underlying media is not locked to PTP, however, the encapsulator of the sender should be locked to PTP for this measurement to be valid.

Virtual Receiver Buffer Measurement (VRX)

A Video RTP sender is required to ensure that the variation in the interval between packets (the instantaneous (or INST) rate) meets the parameters for either a narrow or wide sender. These packets are written into the *leaky-bucket* buffer and are then drained at a precise read schedule. The sender is required to ensure that the maximum size of the leaky-bucket buffer does not exceed the value of **VRX_{Full}** for that format and does not underflow, that is, the minimum value of VRX should not be negative.

The **Analyzer - 2110-21 Status** submenu for the **VRX** parameter contains the following options:

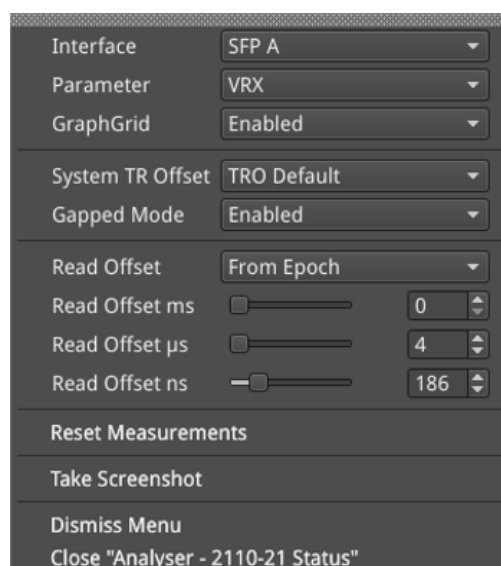

Figure 12-8: Analyzer - 2110-21 Status Menu Options for the VRX Parameter

The menu options available for the **C_{INST}** measurement are as follows:

Table 12-6 : Analyzer - 2110-21 Status - VRX Measurement Options

Item	Options	Description
Interface	SFP A SFP B	Select the target interface for the Analyzer - 2110-21 instrument. When analyzing 2022-7 flows, you switch between SFP A and SFP B.

Item	Options	Description
Parameter	CINST VRX	Select the target measurement for the Analyzer - 2110-21 Status Instrument.
GraphGrid	Enabled (Default) Disabled	When enabled, displays a graphical grid pattern in the instrument background.
System TR Offset	TRO Default (Default) Custom	Defines the timing reference offset (TR Offset) setting. The TR Offset is either a default value based on the current video standard (TRO Default) or a value defined by the sender to account for network delay. Select whether to use the default (TRO Default) as the time at which the read schedule begins on each frame, or select Custom to override the default with a manual TR Offset by adjusting the TR Offset sliders described below to set the granularity in ms, μ s and ns. The read schedule must be set to match that of a Gapped or Linear source, see the Gapped Mode option below.
TR Offset Slider Controls	ms, μ s, ns	Adjust the slider controls to compensate for the network delay, any PTP phase offset, and if required the source Video Timing (TR Offset), to obtain an accurate and consistent measurement.
TR Offset ms	0 to 9	Set the timing reference offset in milliseconds (ms).
TR Offset μ s	0 to 999	Set the timing reference offset in microseconds (μ s).
TR Offset ns	0 to 999	Set the timing reference offset in nanoseconds (ns).
Gapped Mode	Enabled Disabled	For a Gapped source, ensure that you enable the option Gapped Mode .
Read Offset	From Epoch (Default) Toward Epoch	The Read Offset is the time at which packets are read from the <i>leaky bucket</i> . Enables you to set the custom offset relative to the Epoch time, where the Epoch is 00:00:00 UTC on 01 January 1970.
Read Offset Slider Controls	ms, μ s, ns	Adjust the slider controls to compensate for the network delay, any PTP phase offset, and if required the source Video Timing (TR Offset), to obtain an accurate and consistent measurement of VRX.
Read Offset ms	0 to 100	Set the timing reference offset in milliseconds (ms).
Read Offset μ s	0 to 999	Set the timing reference offset in microseconds (μ s).
Read Offset ns	0 to 999	Set the timing reference offset in nanoseconds (ns).
Reset Measurements	System control	Use this control to reset the measurement to the start.

You can use the **Read Offset** control for either of the following tasks:

- To perform a SMPTE ST 2110-21 measurement
- To measure the required Read Offset to ensure that the leaky-bucket does not underflow.

To perform the 2110-21 measurement: set the value of the Read Offset to match the value of the network delay. The 2110-21 Instrument will now report the peak sizes (both positive and negative) of the leaky-bucket buffer. A negative minimum value indicates that the buffer has underflowed.

To measure the Read Offset: adjust the Read Offset controls so that the **VRX_{Min}** value is zero and simultaneously that the **VRX_{Max}** value is also minimized. The value of the Read Offset with the

minimum value for VRX_{Max} and with VRX_{Min} of zero is an indication of the required read offset to ensure that there is no underflow. This measurement will be affected by the network latency, PTP Phase of the sender and the unit, and the Video Timing (TR_{Offset}).

The measurement is sensitive to the time difference between the Write and Read schedules and will vary with the source Video Timing (TR_{Offset}). If the Source Video Timing is not equal to $TRO_{Default}$ then, if required, you can compensate for this by choosing **Custom** mode and entering the value from the **Video Timing & System Reference** Instrument.

Note: For this measurement to be valid, both the underlying media and the source encapsulator must be locked to PTP.

Advanced Media Timing Measurement (IP 2110 Mode)

Requires Option(s):	PHQXO-IP-STND and PHQXO-IP-MEAS
---------------------	---------------------------------

Overview

The Advanced Media Timing measurement functions are provided with the license PHQXO-IP-MEAS. These advanced functions give you access to additional measurements from the standard Video Timing & System Reference instrument, which provide critical information on the performance of your media network.

The advanced **Video Timing & System Reference** instrument is extended in width, by default, to display the actual flow data to complement the visual information in the flow timing meters.

Note: The unit must be locked to PTP for the advanced media timing measurements to be valid.

Note: The unit has a PTP phase control that you can use to align the one pulse per second (1 PPS) of the unit with that of the PTP Grandmaster. The use of this control reduces any PTP-related timing measurement uncertainty caused by PTP network asymmetry, however, there may still be a PTP phase uncertainty introduced by the sending device. For more information, see the section ["SFP A/B - PTP Info \(IP 2110 Mode\)" on page 5-17.](#)

When your system includes the **PHQXO-IP-MEAS** license, the **Video Timing & System Reference** window includes the following three tabs, providing access to different timing data:

- Video Timing
- Media Latency
- External Reference vs PTP

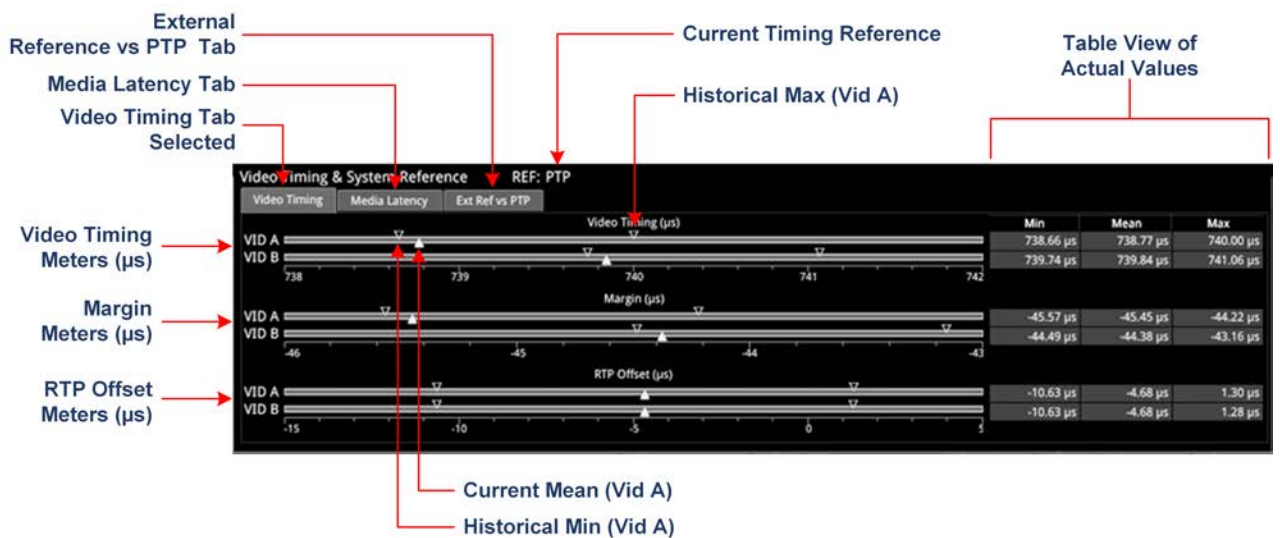

Figure 12-9: Components of the Video Timing & System Reference Instrument (IP 2110 Mode)

Using the Advanced Video Timing Tab

The Advanced Video Timing tab provides listings of the actual historical minimum, mean and maximum values in the Min, Mean and Max columns to the right of the timing meters.

The advanced Video Timing tab displays the following measurements:

- Video Timing (μs)
- Margin (μs)
- RTP Offset (μs)

Detailed information about the Video Timing tab and these measurements is provided in the Appendix ["Advanced Media Timing Measurements" on page B-2.](#)

Using the Advanced Media Latency Tab

The advanced **Media Latency** tab provides additional media latency measurements to those in the standard instrument.

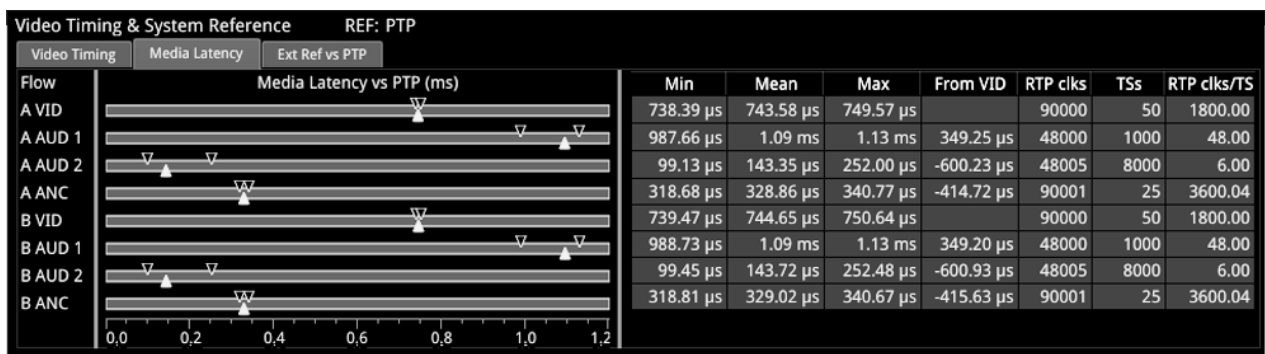

Figure 12-10: Media Latency Tab of the Video Timing & System Reference Instrument (IP 2110 Mode)

The displays the media latency data in the following columns for each flow:

- **Min:** Minimum historical flow latency (since last reset)
- **Mean:** Mean current flow latency (since last reset)
- **Max:** Maximum historical flow latency (since last reset)
- **From Vid:** Displays the difference in latency for the audio (A AUD 1 and A AUD 2) and ancillary (A ANC) flows from their related video (A VID) flow. If the flow arrives earlier than its related video flow, the value is negative and if it arrives later, the value is positive.
- **RTP clks:** Actual value of the RTP Clock, averaged over one second. For more information, see the section ["Advanced Media Timing Measurement \(IP 2110 Mode\)" on the previous page](#)
- **TSs:** Number of timestamps received over one second. For more information, see the section ["Advanced Media Timing Measurement \(IP 2110 Mode\)" on the previous page](#)
- **RTP clks/TS:** Quotient of RTP clks and TS provides a measure of the number of RTP Clocks per timestamp. For more information, see the section ["RTP Clocks per Timestamp Quotient \(RTP/TS\)" on page B-10.](#)

To see more detail about the media latency, you can zoom in on a specific area of interest by clicking anywhere on a timing meter of interest, which changes the scale to match the values of the specific flow. For example, when zooming into a video flow, the scale changes from milliseconds (ms) to microseconds (μs). Click the meter again to zoom out and return to the overview. You can also switch between overview and zoom for individual flow meters by selecting the specific meter from the instrument submenu, as described in the Instrument options table.

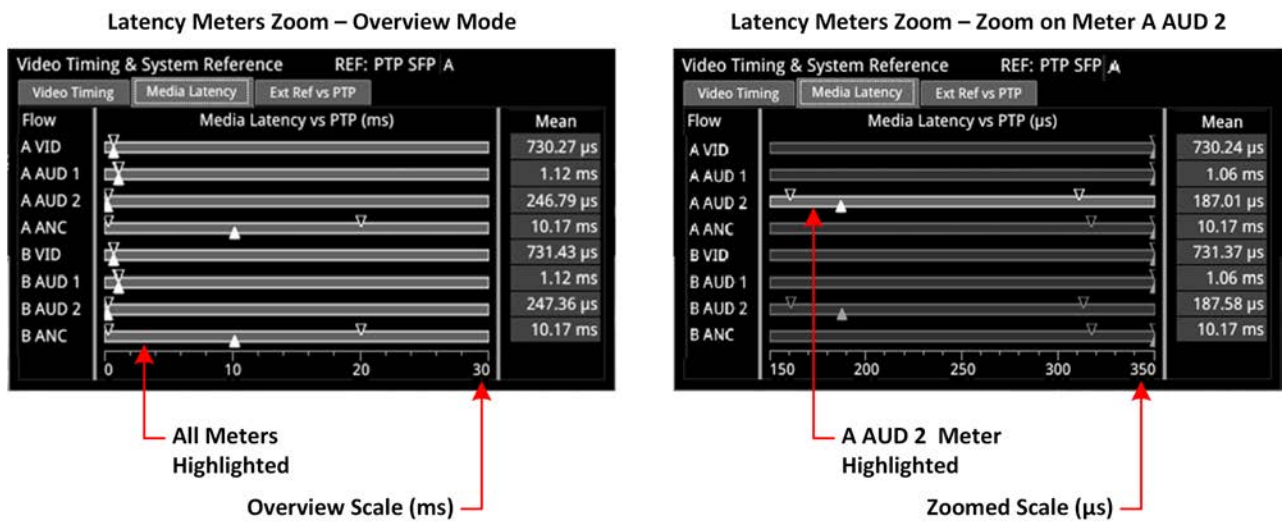

Figure 12-11: Media Latency Tab of the Video Timing & System Reference Instrument (IP 2110 Mode)

Detailed information about the Media Latency measurement is provided in the Appendix ["Advanced Media Timing Measurements"](#) on page B-2.

Instrument Menu Options

The following table lists the options available in both the standard and advanced **Video Timing & System Reference** Instrument submenu:

Table 12-7 : Video Timing & System Reference - Menu Options

Item	Options	Description
System Reference	PTP External Reference	System reference locking controls define the reference to which the unit and any signal it generates is locked. In IP 2110 mode, make sure that the system reference is stably locked to the same PTP source as the sending device. System reference lock status information is displayed in the upper-right corner of the instrument, and any error in the health state of the reference is displayed in red.
Reference Timing Meter Range	+/- 0.1 line, +/- 0.5 line, +/- 0.5 frame	Adjusts the displayed range of the reference timing meter in the upper section of the Instrument to display readings at frame scale, or to zoom in to a fraction of a line.
System TR Offset	TRO Default Custom	Defines the timing reference offset (TR Offset) setting. The TR Offset is either a default value based on the current video standard (TRO Default) or a value defined by the sender to account for network delay. When you select TR Offset, you can set the TR Offset by adjusting the TR Offset sliders described below to set the granularity in ms, µs and ns.
TR Offset ms	0 to 9	Set the timing reference offset in milliseconds (ms).
TR Offset µs	0 to 999	Set the timing reference offset in microseconds (µs).
TR Offset ns	0 to 999	Set the timing reference offset in nanoseconds (ns).

Item	Options	Description
Wrap Video Timing	Enabled / Disabled (Default)	When enabled, displays video timing values exceeding half a TV frame period as a negative time value relative to the next TV frame, rather than as a positive value. For example, for a frame of 20 ms, if the frame end is measured at 30 ms, the unit will display this as – 10 ms instead of 30 ms.
Wrap Margin	Enabled / Disabled (Default)	When enabled, displays margin timing values exceeding half a TV frame period as a negative time value relative to the next TV frame, rather than as a positive value.
Wrap RTP Offset	Enabled / Disabled (Default)	When enabled displays RTP Offset timing values exceeding half a TV frame period as a negative time value relative to the next TV frame, rather than as a positive value.
Latency Meters Zoom	Overview, A VID, A AUD 1, A AUD 2, A ANC, B VID, B AUD 1, B AUD 2, B ANC	Select a specific timing meter to switch between overview and zoomed-in view.
Anchor time scale start in Overview mode	Zero (0) or less, Any value	Set the start point of the timescale when in Overview.
Clear Min, Max values	N/A	Set the historical minimum and maximum values back to zero.

12G Physical Layer Analysis

Note: Requires the **PHQXM-01E Mezzanine** hardware option.

This chapter describes the Instruments available with the 12G-SDI Physical Layer Analysis Toolset option and includes the following sections:

- [Eye - SDI In A](#)
- [Jitter - SDI In A](#)

Eye - SDI In A (Physical Layer Analysis Mode)



Requires Option(s):	PHQX01E-3G
---------------------	------------

Overview

The optional instrument **Eye - SDI in A**, available in the **Physical Layer Analysis** toolset, enables you to analyze physical layer compliance measurements at up to 12 Gbps. An analog front-end provides a bandwidth of more than 30 GHz (5th harmonic of the 6 GHz fundamental for 12G-SDI.) The GUI uses PHABRIX RealTime Eye (RTE™) to generate a reliable, AC coupled, instantaneous physical layer display with automatic measurements to SMPTE standards.

You can receive accurate measurements within seconds of connecting an SDI signal. The unit enables you to measure both rise and fall overshoot at the top and bottom of the waveform. In addition, the unit displays amplitude, rise and fall overshoot delta and DC offset - all compulsory measurements when testing against SMPTE standards. The unit highlights any measurements exceeding the specification (for example, an eye amplitude greater than 10 %) in red.

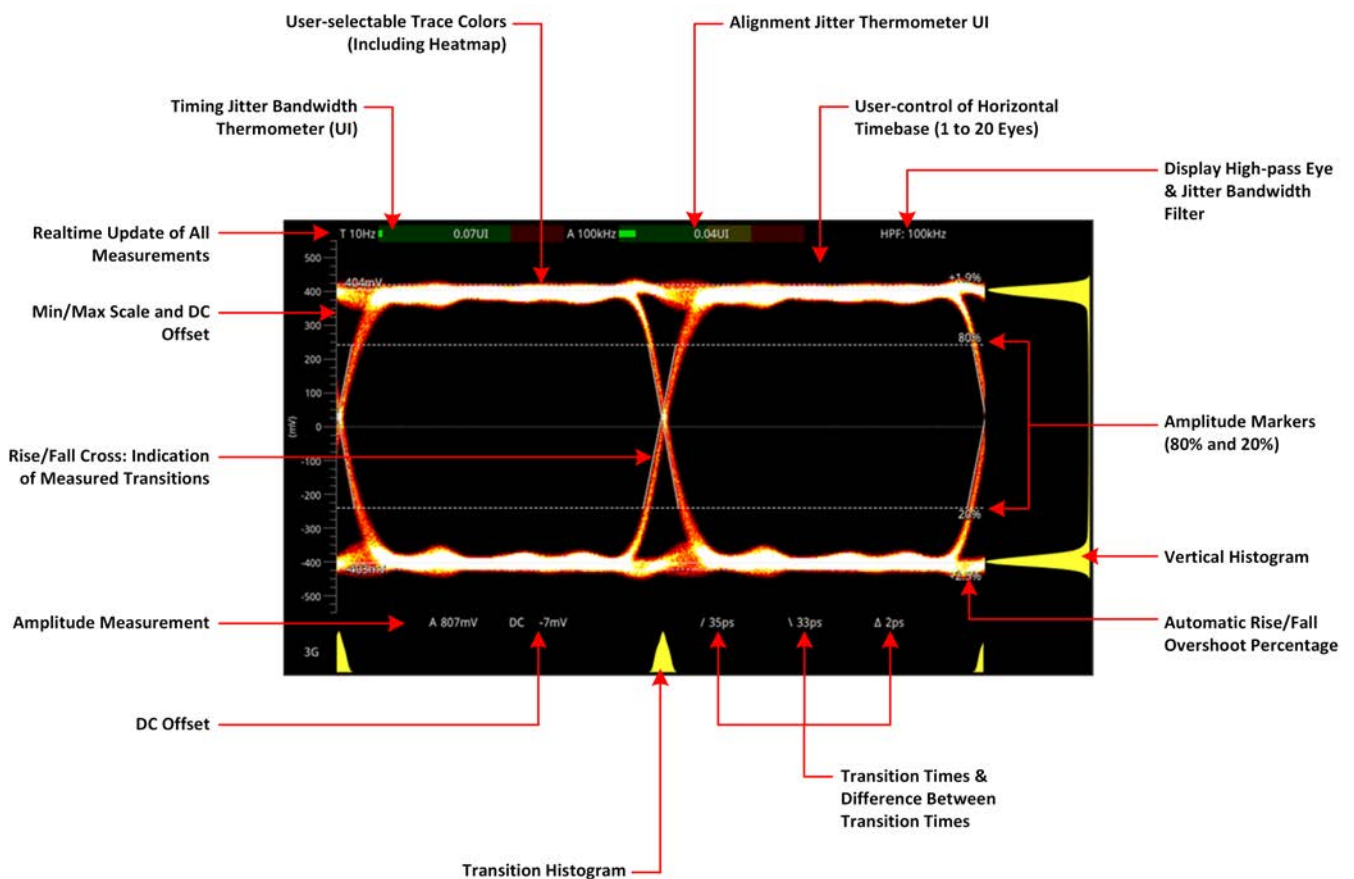

Figure 13-1: Standard SDI Eye Pattern Display (3G) with 100 kHz Jitter Filter

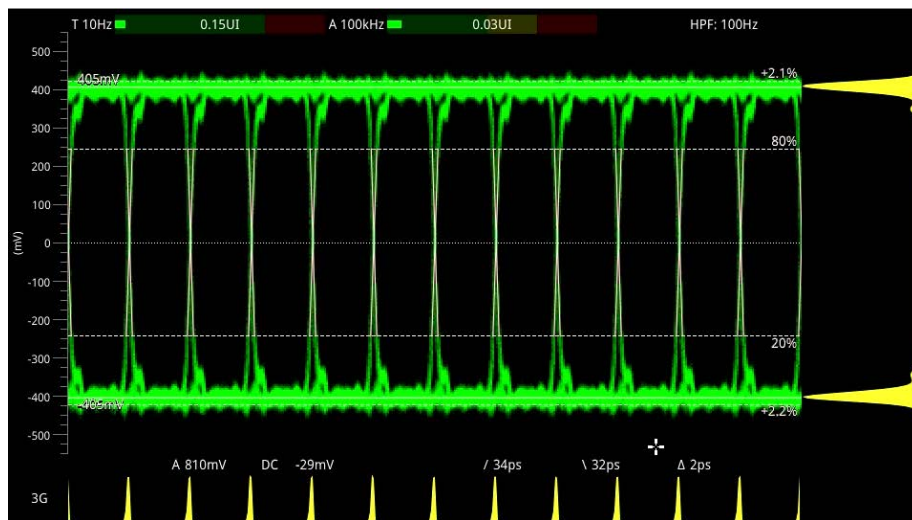

Figure 13-2: 3G-SDI Eye Pattern Set to Display 12 Eyes (Using Green Display Color)

Note: A black (or red) nut fitted to the **SDI In A** BNC identifies the connector with access to the eye and jitter circuitry.

Note: The use of SDI SFP inputs with **Eye - SDI In A** is not supported.

The **Eye - SDI In A** instrument display also provides:

- Timing jitter thermometer color-coded according to the analyzed SDI standard
- Alignment jitter thermometer color-coded according to the analyzed SDI standard
- Positive and negative Eye amplitude values
- On screen indication of 20 % and 80 % levels for rise and fall time measurement
- Horizontal time histogram of eye crossing point (0 mV threshold)
- Vertical amplitude histogram indicating energy distribution across all samples
- Eye coupled to AC with display of DC offset measurement.

Instrument Menu Options

The Physical Layer Analysis toolset provides the following options in the right-click submenu.

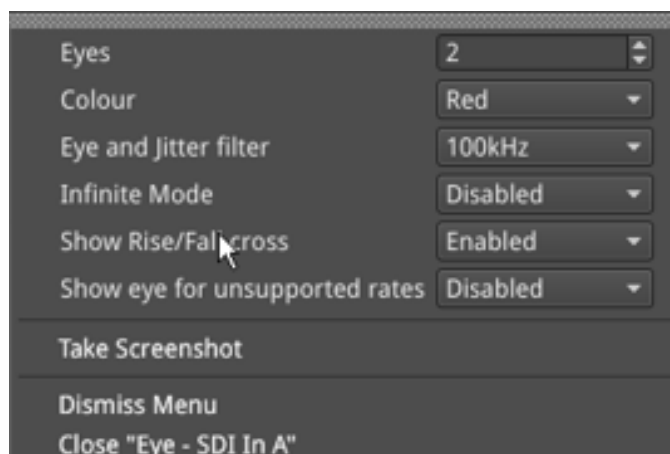

Figure 13-3: Eye - SDI In A Menu Options

Table 13-1: Menu Options for the Eye - SDI In A Instrument (SDI Mode)

Item	Options	Description
Standard Physical Layer Analysis Tools		
Eyes	1 to 20 (Default = 2)	Sets the default number of eyes displayed in the Instrument window.
Color	Green Heat Red Ferrara Green-red Blacklight	Sets the color scheme for the eye display.
Eye and Jitter Filter	10 Hz 100 Hz 1 kHz 10 kHz 100 kHz	Sets the frequency of the default jitter filter. Note: This setting controls the filter applied both to the Eye - SDI In A instrument and the Jitter - SDI A instrument.
Infinite Mode	Disabled (Default) Enabled	When disabled, eye data points are displayed for a fixed persistence interval and then removed from the display. When enabled, infinite mode ensures that no data points are removed from the eye display over time, so you will probably observe the eye shape thickening and becoming less distinct. This can be useful when attempting to identify anomalies in the signal which appear sporadically over time and might be missed in the standard mode.
Show Rise/Fall Cross	Disabled (Default) Enabled	Toggle the display of the rise/fall crossing point, which gives a visual indication of the rise and fall time measurements.
Show eye for unsupported rates	Disabled (Default) Enabled	Toggle the display of eyes for rates currently unsupported by the unit.

A table showing the SMPTE tolerances for each standard is provided in the section ["SMPTE UHDTV: SDI Physical Layer Tolerances" on page C-1.](#)

Jitter - SDI In A (Physical Layer Analysis Mode)



Requires Option(s):

PHQX01E-3G

Overview

The **Jitter** toolset is available on the **SDI In A** BNC - the rear panel connector fitted with the black (or red) nut.

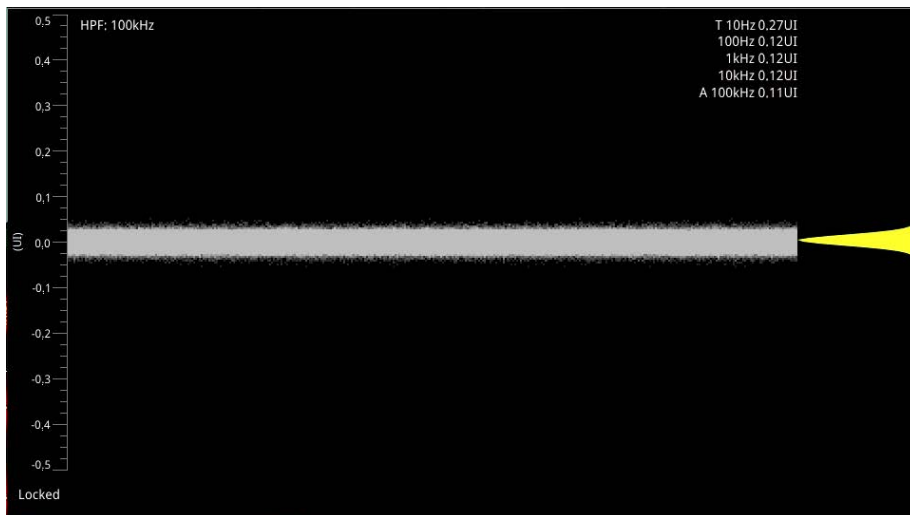

Figure 13-4: Jitter SDI In A Instrument

The **Jitter** instrument displays automated measurements to SMPTE standards. A Jitter histogram, displayed at the right of the window in yellow, provides additional information about the jitter waveform.

Readings for each of the filters are displayed as an overlay in the top-right corner of the instrument window. Any values displayed in red text indicate a reading outside the current specification.

Instrument Menu Options

As with the **Eye** instrument, you can display the following submenu options by right-clicking in the instrument window:

- Scale > [Adjust the scale of the Y-axis in graticule adjustments from 1 UI to 128 UI]
- Trigger > [None, Single Line, Two Lines, Single Field, Frame]
- Eye and jitter filter > [10 Hz, 100 Hz, 1 kHz, 10 kHz, 100 kHz]

Note: This setting controls the filter applied to both the Jitter - SDI A instrument and the Eye - SDI In A instrument. If you hover over the HPF field in the top-left of the screen, a tooltip displays the frequency response of the current high-pass filter.

- Infinite Mode > [Enabled, Disabled]
- Jitter Color > Waveform color selection

Color selection is by way of an HSV tool providing two cursors. The left-hand color rectangle allows selection of hue (horizontal) and saturation (vertical). The right-hand vertical bar selects color lightness.

- Show jitter for unsupported rates > [Enabled, Disabled]

Trigger modes are useful for correlating jitter content to line and frame-rate frequencies.

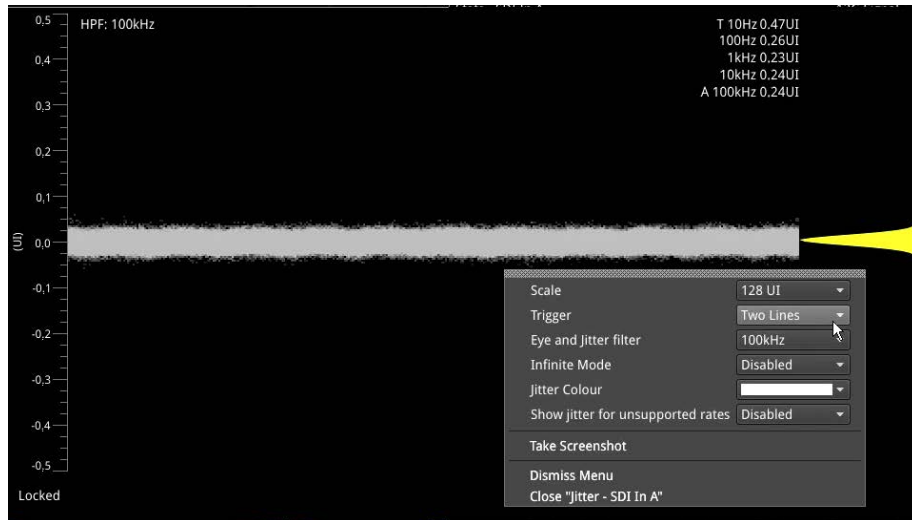

Figure 13-5: Jitter SDI In A Menu Options

The Jitter and Eye analysis instruments, used in conjunction with the **Jitter Insertion Mode** feature of **Generator – Video Standard** - available in **SDI Stress Toolset** mode [option: PHQXO-SDI-STRESS], provide an end-to-end jitter generation and analysis toolset.

Note: The use of SDI SFP inputs with the **Jitter - SDI In A** toolset is not supported.

Stress-testing Analysis Instruments

Note: Requires the **PHQXO-SDI-STRESS** License.

The Stress-testing analysis Instruments provide additional SDI stress-testing functions and complement the Physical Layer Analysis Instruments described in the previous chapter.

This chapter describes the advanced stress testing Instruments available with the SDI-Stress Toolset option and includes the following sections:

- [Advanced Generation Tools](#)
- [Eye - SDI In A](#)
- [PRBS Analysis](#)

Advanced Generation Tools (SDI Stress Mode)



Requires Option(s):

PHQXO-GEN, PHQX01E-3G and PHQXO-SDI-STRESS

Overview

As part of the Advanced SDI Stress Toolset [**PHQXO-SDI-STRESS**], advanced generation tools are provided in the Generate - Video instrument submenu, in SDI Stress Toolset Mode. The toolset provides the following:

- Control over SDI scrambler switch-off
- Sync bit insertion
- A PRBS (pseudo-random binary sequence) mode for end-to-end bit error rate testing (BERT)
- Advanced jitter generation controls – facilitating the generation and bespoke adjustment of jitter measurement parameters
- Slew rate adjustment
- SDI output gain control
- Driver pre-emphasis
- Cable compensation.

These tools support a wide range of advanced testing and troubleshooting.

SDI Scrambler

The selected video standard data stream can be made to bypass the SMPTE scrambler, just prior to the output stage. To bypass the scrambler, disable it by selecting:

- Advanced Generation Tools (BNC) > SDI Scrambler > [Enabled, Disabled]

Note: For the generation of conventional video, the default state for the SDI Scrambler is Enabled.

Sync Bit Insertion (6G / 12G)

Sync bit insertion prevents the occurrence of a pathological condition that results in the removal of sync bits, also referred to as *potholing*. Before the output, a sync bit is applied to the Timing Reference Signal (TRS) and Ancillary Data Flag (ADF) words of the generated video standard. Sync Bit Insertion can be enabled and disabled in the submenu:

- Advanced Generation Tools (BNC) > Sync Bit Insertion > [Enabled, Disabled]

Note: This feature applies only to 6G-SDI and 12G-SDI video standards.

Note: The insertion of the sync bit is observable in the video signal TRS and ADF words seen in Analyzer - Dataview when the option Sync Bit Removal is disabled.

PRBS Mode

In addition to SDI test signal generation, for the stress testing of SDI infrastructure the unit offers end-to-end BERT capability, with the addition of PRBS generation and analysis tools.

A variety of PRBS signals can be generated:

- Advanced Generation Tools (BNC) > PRBS Mode > [Disabled, PRBS-7, PRBS-9, PRBS-15, PRBS-23, PRBS-31]

Once selected, a PRBS signal can be inverted. Errors can also be inserted into the stream:

- Advanced Generation Tools (BNC) > PRBS Mode > PRBS Signal Inversion > [Enabled, Disabled]
- Advanced Generation Tools (BNC) > PRBS Mode > PRBS Error Insertion > [Enabled, Disabled]

Note: Both the **Generator - Video Standard** pane and the **Generator – Status** instrument indicate when a PRBS signal is being generated.

Note: PRBS signal analysis is available in the **PRBS – Analysis** instrument window.

Jitter Insertion

In order to stress the interface and ensure that receivers comply with SMPTE recommended practice you can insert Jitter into any generated SDI signal. You can insert sinusoidal jitter with a frequency ranging from 10 Hz to 10 MHz and adjust the peak-to-peak jitter amplitude.

Enable jitter insertion:

- Advanced Generation Tools (BNC) > Jitter Insertion Mode > [Disabled, Sine]

Enabling jitter insertion reveals a setting for specifying the frequency of the jitter wave:

- Advanced Generation Tools (BNC) > Jitter Insertion Mode > Frequency > [1.0 Hz to 10.0 MHz]

Note: For precision setting adjustment and frequencies below 10 Hz use the up/down arrow buttons or input values via a USB keyboard.

Peak-to-peak jitter amplitude can be adjusted, with jitter amplitude measured in terms of signal Eye **Unit Interval (UI)**:

- Advanced Generation Tools (BNC) > Jitter Insertion Mode > Amplitude P-P > [slider, 0.01 to 127.99 UI, dependent on frequency]

Warning: SDI outputs B, C and D may be corrupted when jitter is inserted.

Note: Jitter can be observed in the **Eye – SDI In A** and **Jitter – SDI In A** instrument windows. For analysis, apply filters and other settings in the Eye and Jitter instruments as required. For more information on Eye and Jitter analysis, see the sections:

["Eye - SDI In A \(Physical Layer Analysis Mode\)" on page 13-2](#) and ["Jitter - SDI In A \(Physical Layer Analysis Mode\)" on page 13-5](#).

Slew Rate

The slew rate of the generated signal can be adjusted from its default setting:

- Advanced Generation Tools (BNC) > Slew Rate > [Default, Slow, Fast]

Fast is the standard slew rate for 12G signals.

Slow (10% slower than Fast) is the standard slew rate for HD, 3G, and 6G signals.

Default automatically provides the standard slew rate for any signal being generated.

If required, you can select a slower slew rate for 12G signals or a faster slew rate for HD, 3G, and 6G signals.

Driver and Output Control

You can increase or decrease the signal gain of **SDI Out A** by up to 15 % in increments of 1 %:

- Advanced Generation Tools (BNC) > Driver A Gain > [+/- 0, 1, 2, 3, 4, 5, 6, 7, 8, 9, 10, 11, 12, 13, 14, 15 %]

Note: Units upgraded from software release 2.3 or earlier will first require Driver A calibration. For instructions on driver calibration, see the section ["Driver Calibration" on page 16-5](#).

For SDI Out A, driver pre-emphasis can be adjusted to boost the signal at the beginning of the rising edge of the eye pattern to optimize signal integrity.

- Advanced Generation Tools (BNC) > Driver Pre-Emphasis > [Disabled, 0.5 dB, 1.0 dB, 1.5 dB]

For more information on the Eye pattern display, see the section ["Eye - SDI In A \(SDI Stress Mode\)" on page 14-6](#).

With Driver Pre-Emphasis enabled, the pre-emphasis time constant can be left as default, or changed - divided by 2, 4, or 8 - to adjust the length of time the signal is boosted:

- Advanced Generation Tools (BNC) > Driver Pre-Emphasis > Time-Constant > [Default, Div 2, Div 4, Div 8]

Cable Compensation

By default the unit compensates for the attenuation across a one meter length of SDI cable to ensure that the Eye amplitude at the end of the 1 m cable meets the SMPTE standard of 800 mV.

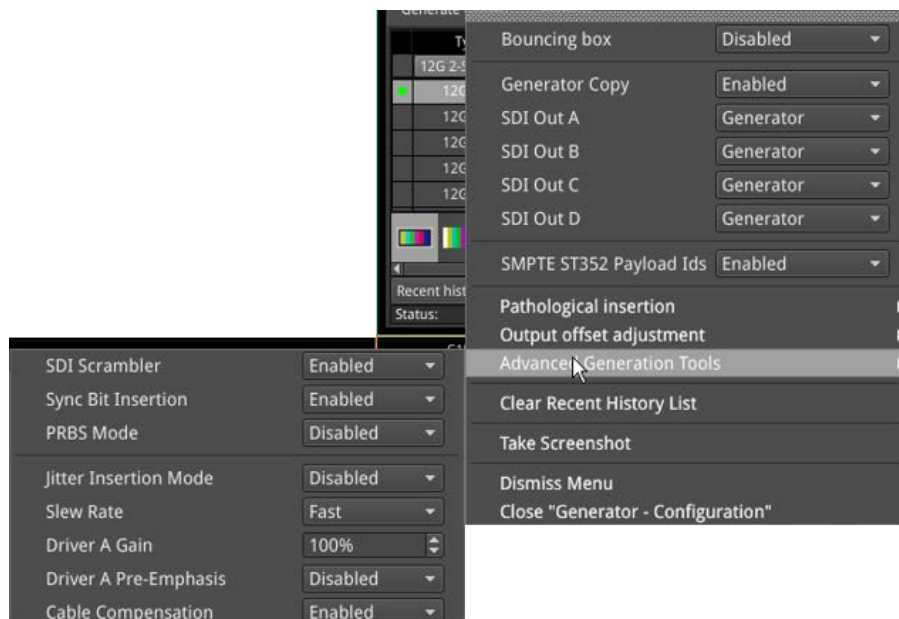

Figure 14-1: Advanced Generation Tools Option Menu

You can use the **Cable Compensation** option to disable this default attenuation compensation if required, as follows:

- Advanced Generation Tools (BNC) > Cable Compensation > [Enabled (Default), Disabled].

Eye - SDI In A (SDI Stress Mode)



Requires Option(s):	PHQX01E-3G, PHQXO-GEN and PHQXO-SDI-STRESS
---------------------	--

Overview

The optional instrument **Eye - SDI in A**, available in the **Stress Testing Analysis** toolset, provides additional tools for stress testing and R&D evaluations of your SDI interfaces at up to 12 Gbps. An analog front-end supplies a bandwidth of more than 30 GHz (5th harmonic of the 6 GHz fundamental for 12G-SDI.) The GUI uses PHABRIX RealTime Eye (RTE™) to generate a reliable, AC-coupled, instantaneous physical layer display with automatic measurements to SMPTE standards.

You can receive accurate measurements within seconds of connecting an SDI signal. The unit enables you to measure both rise and fall overshoot at the top and bottom of the waveform. In addition, the unit displays amplitude, rise and fall overshoot delta and DC offset - all compulsory measurements when testing against SMPTE standards. The unit highlights any measurements exceeding the specification (for example, an eye amplitude greater than 10 %) in red.

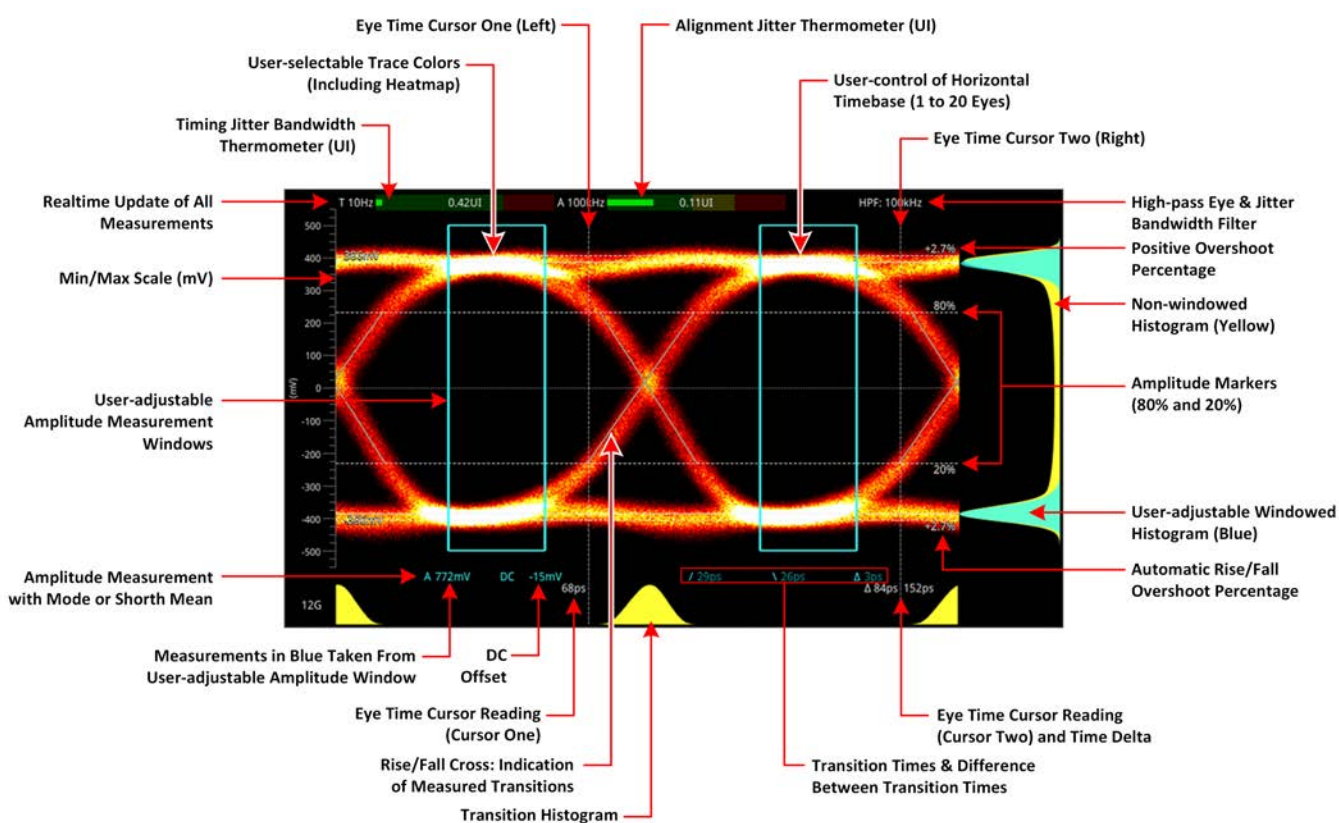

Figure 14-2: 12G-SDI Eye Pattern Display with 100 kHz Jitter Filter

Use the eye amplitude histogram, showing the distribution of samples over the complete visible eye waveform, to calculate the automatic eye amplitude measurement. The default analysis method is **Mode**.

Note: A black (or red) nut fitted to the **SDI In A** BNC identifies the connector with access to the eye and jitter circuitry.

Note: The use of SDI SFP inputs with **Eye - SDI In A** is not supported.

The **Eye - SDI In A** instrument display also provides:

- Timing jitter thermometer color-coded according to the analyzed SDI standard
- Alignment jitter thermometer color-coded according to the analyzed SDI standard
- Positive and negative Eye amplitude values
- On screen indication of 20 % and 80 % levels for rise and fall time measurement
- Horizontal time histogram of eye crossing point (0 mV threshold)
- Vertical amplitude histogram indicating energy distribution across all samples
- Eye coupled to AC with display of DC offset measurement
- A pair of vertical Eye time cursors to generate and display time measurements across the Eye display.

Using the Eye Time Cursors

When enabled, the Eye time cursors are displayed as a pair of vertical dashed lines, when static.

You can choose to position the Eye time cursors independently or link the cursors together so that they move as a single unit with a fixed time separation. In addition, cursor readings below the trace display the time measurements in picoseconds (ps) from the start of the trace, and show the delta between the two cursors.

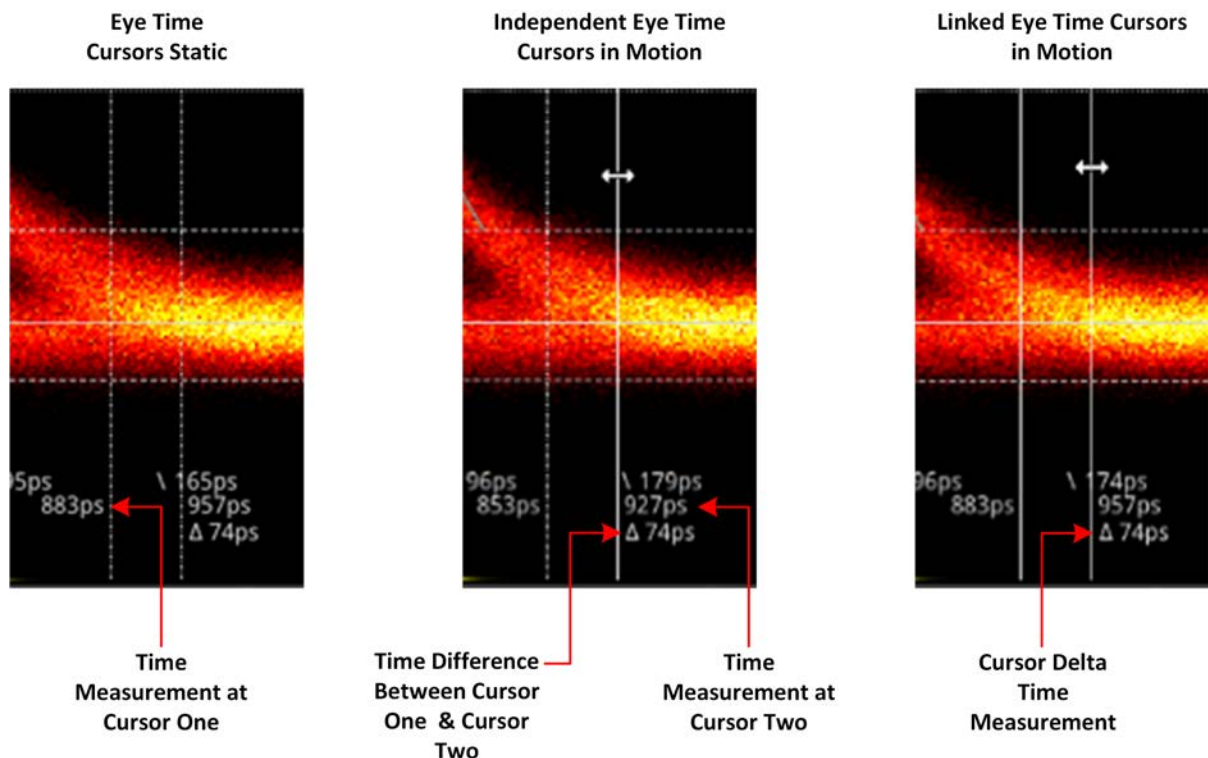

Figure 14-3: Advanced SDI Stress Option: Eye Time Cursors

You can use the mouse connected to the unit to click then drag a cursor or both cursors to a new position. When in motion, the dashed line of the cursor changes to a solid white line for improved visibility. You will see the time measurements below the Eye change in real-time as you adjust the cursor(s).

However, if using remotely, use the **Cursor One** and **Cursor Two / Cursor Delta** fields in the Instrument submenu to adjust the time cursor positions.

Instrument Menu Options

The Stress Testing toolset provides the following options in the right-click submenu.

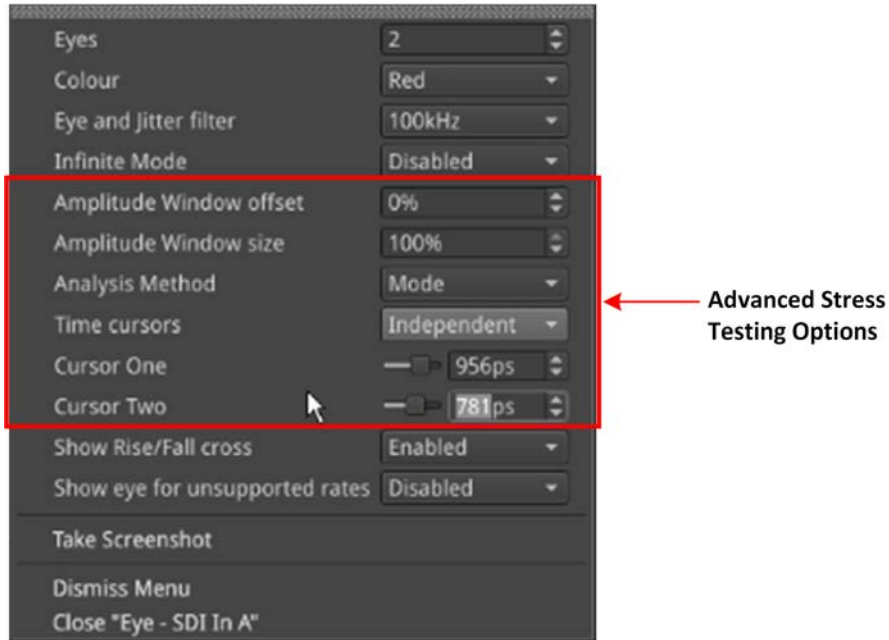

Figure 14-4: Eye - SDI In A Menu Showing Advanced Stress Testing Options

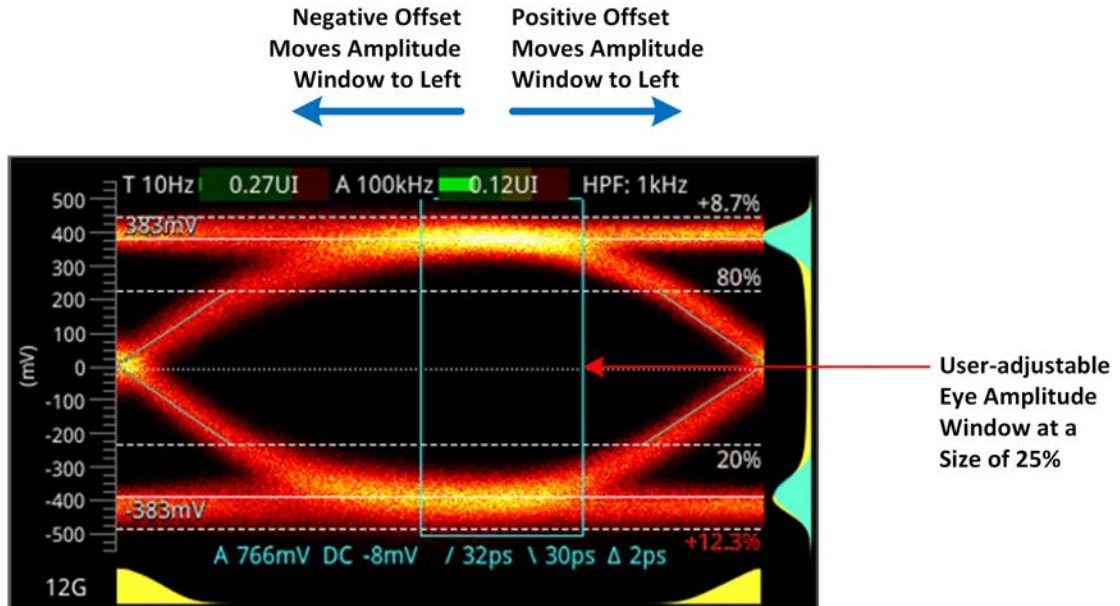

Figure 14-5: Advanced SDI Stress Option: Amplitude Window

The following table lists the options available in the submenu for the Eye - SDI In A Instrument in SDI Stress Testing Mode.

Table 14-1: Menu Options for the Eye - SDI In A Instrument (SDI Stress Mode)

Item	Options	Description
Standard Physical Layer Analysis Tools		
Eyes	1 to 20	Sets the default number of eyes displayed in the Instru-

Item	Options	Description
	(Default = 2)	ment window.
Color	Green Heat Red Ferrara Green-red Blacklight	Sets the color scheme for the eye display.
Eye and Jitter Filter	10 Hz 100 Hz 1 kHz 10 kHz 100 kHz	Sets the frequency of the default jitter filter. Note: This setting controls the filter applied both to the Eye - SDI In A instrument and the Jitter - SDI A instrument.
Infinite Mode	Disabled (Default) Enabled	When disabled, eye data points are displayed for a fixed persistence interval and then removed from the display. When enabled, infinite mode ensures that no data points are removed from the eye display over time, so you will probably observe the eye shape thickening and becoming less distinct. This can be useful when attempting to identify anomalies in the signal which appear sporadically over time and might be missed in the standard mode.
Show Rise/Fall Cross	Disabled (Default) Enabled	Toggle the display of the rise/fall crossing point, which gives a visual indication of the rise and fall time measurements.
Show eye for unsupported rates	Disabled (Default) Enabled	Toggle the display of eyes for rates currently unsupported by the unit.
Stress Option: Amplitude Window		
Amplitude Window	The Amplitude Window, available in the Advanced SDI Stress Testing toolset, is an additional tool for more detailed analysis and measurement of the eye amplitude.	
Amplitude Window offset	-49 to 50% 0% Default	Only active when the amplitude window size is set to any value between 0 and 99%. Use the offset to move the Amplitude window to an optimum position on the eye for your measurement. A negative offset moves the window to the left and a positive offset, to the right.
Amplitude Window size	1 to 100% 100% (Default)	The amplitude window is defined by the enclosed area containing the eye data points used for eye amplitude measurements. All samples in the window area are used in the amplitude histogram measurement. You can use this option to define a window to focus on a specific part of the eye on which to take the amplitude measurements. When the size is set to the default 100%, the amplitude window is the entire active window of the Instrument. The size percentage relates to the percentage width of a single eye, so when set to 50% the Amplitude window covers 50% of an eye width and so on.

Item	Options	Description
Stress Option: Analysis Method		
Analysis Method	Mode (Default) Shorth Mean	Switches the statistical analysis method used for the eye amplitude data. Select between either standard Mode analysis or Shorth Mean analysis.
Stress Option: Eye Time Cursors		
Time Cursors	Independent Linked Disabled (Default)	When selected, the Independent option allows you to move the two cursors independently of each other. When selected, the Linked option allows you to move both cursors together, separated by a fixed time delta. You can increase or decrease the separation by adjusting the Cursor Delta setting (see below).
Cursor One	Slider and incremental combo box	Use the slider or combo box to move the left-hand cursor (when set to Independent) or both cursors (when set to Linked) across the Eye display. Increase the time (in ps) to move to the right or decrease to move to the left. When set to Independent, you will see the delta measurement between the two cursors increase or decrease. The left hand y-axis is equivalent to 0 ps.
Cursor Two (Independent Cursors)	Slider and incremental combo box	Use the slider or combo box to move the right-hand cursor across the Eye display. Increase the time (in ps) to move to the right or decrease to move to the left. You will see the delta measurement between the two cursors increase or decrease. The left hand y-axis is equivalent to 0 ps.
Cursor Delta (Linked Cursors)	Slider and incremental combo box	Use the slider or combo box to adjust the separation between linked cursors across the Eye display. Increase the time (in ps) to increase the separation or decrease to reduce the separation. You will see that the delta measurement between the two cursors remains constant as you position the two cursors as a single unit. The left hand y-axis is equivalent to 0 ps.

A table showing the SMPTE tolerances for each standard is provided in the section ["SMPTE UHD TV: SDI Physical Layer Tolerances" on page C-1.](#)

PRBS Analysis (SDI Stress Mode)



Requires Option(s):	PHQX01E-3G, PHQXO-GEN and PHQXO-SDI-STRESS
---------------------	--

Overview

The **PRBS - Analysis** instrument displays the total amount of received pseudorandom binary sequence (PRBS) data, total number of errors, bit error rate (BER), and OK time (since last error), for each SDI input link (BNC or SFP) on the unit.

	SFP SDI In A	SFP SDI In B	SFP SDI In C	SFP SDI In D
Signal (user defined)	3G	3G	3G	3G
Total Rx (Gb)	674	674	0	0
Total Errors	1	1	0	0
Bit error rate (/s)	5.5198e-11	5.5198e-11	0	0
OK Time	3m 46s	3m 46s		

Figure 14-6: PRBS - Analysis

Instrument Menu Options

For BNC and SDI SFP inputs, you can manually activate PRBS analysis from the instrument submenu. The incoming PRBS signal type can be selected if known:

- PRBS Analysis Mode > [Disabled, PRBS-7, PRBS-9, PRBS-15, PRBS-23, PRBS-31]

For PRBS analysis on SDI SFP inputs, a further field is displayed where the appropriate signal data rate and divisor must be selected in order for PRBS analysis to be accurate:

- PRBS Data Rate / Divisor > [None, Rate: 1G5 Divisor: 1000, Rate: 1G5 Divisor: 1001, Rate: 3G Divisor: 1000, Rate: 3G Divisor: 1001, Rate: 6G Divisor: 1000, Rate: 6G Divisor: 1001, Rate: 12G Divisor: 1000, Rate: 12G Divisor: 1001]

In addition, for SDI BNC inputs only, automatic PRBS analysis is available. By enabling auto scan mode, the unit will automatically cycle once, through all available PRBS Analysis modes and select the correct mode for the incoming signal type:

- PRBS auto scan mode > [Enabled, Disabled]

Once auto scan is complete, it will be automatically disabled.

An incoming PRBS signal can be inverted:

- PRBS signal inversion > [Enabled, Disabled]

To reset the PRBS – Analysis table, select:

- Reset

Note: PRBS signal generation is available in the **Generator - Video Standard** instrument submenu, as part of the **Advanced Generation Tools**, in SDI Stress Toolset Mode [PHQXO-SDI-STRESS].

HDR Analysis Instruments

Note: This option requires the Advanced High Dynamic Range (HDR) License: **PHQXO-HDR**.

This chapter describes the Instruments available with the High Dynamic Range (HDR) Toolset option and includes the following sections:

- [Advanced HDR Toolset](#)
- [Analyzer - CIE Chart](#)
- [HDR Heat-map \(False Color Overlay Tools\)](#)

Advanced HDR Toolset

Requires Option(s):	PHQXO-HDR
---------------------	-----------

Overview

The comprehensive advanced HDR toolset includes a signal generator for HDR test patterns, CIE chart Analyzer, Luma false color highlighting (or heat map), a waveform monitor and vectorscope. The HDR toolset supports all the main live production formats for both SDR and HDR.

For Standard Dynamic Range (SDR), the toolset supports:

- BT.709
- BT.2020

For High Dynamic Range (HDR), the toolset supports:

- BT.2100 HLG
- PQ
- Sony S-Log3
- Sony SR Live

The Waveform provides a Cd/m² (nits) graticule along with BT.2048 diffuse white markers. The flexible user-controlled HDR heatmap highlights signals beyond SDR with seven simultaneous programmable color overlay bands with presets for HDR and SDR ranges, plus a user-definable preset. The CIE 1931 x,y display provides overlays for BT.709, BT.2020 and ST.2086 gamut (P3) to enhance the visualization and analysis of your HDR/WCG content.

An extensive set of test patterns include BT.2111 HDR color bars for HLG, PQ and SR Live as well as a full set of SDR 709 patterns mapped using *display light* to each of the four HDR formats for line checks, comparative monitor set-up and evaluation of HDR to SDR converters.

HDR Test Patterns

In addition to the standard SDR test patterns which are converted to HDR, the Advanced HDR toolset provides an additional two native HDR test patterns. These test patterns are available when you select one of the following HDR WCG (Wide Color Gamut) options from the **Gamut** dropdown list of the **Generate - Video** Instrument:

- HDR HLG 2020
- HDR PQ 2020
- HDR S-Log3 2020
- HDR SR Live

The list of available test patterns for a selected video standard is displayed at the bottom or in the right hand column of the **Generate - Video** Instrument. The native HDR test patterns are as follows:



ITU-R BT.2111-0 HDR Color Bars



ITU-R BT.814-4 PLUGE – 4 variants

Figure 15-1: Available HDR Test Patterns

In addition, all other test patterns are converted to HDR in HDR mode, see the section ["Test Patterns" on page 6-3](#) for a detailed list.

Both S-Log3 and SR Live [S-Log3(HDR Live)] test pattern variants are available.

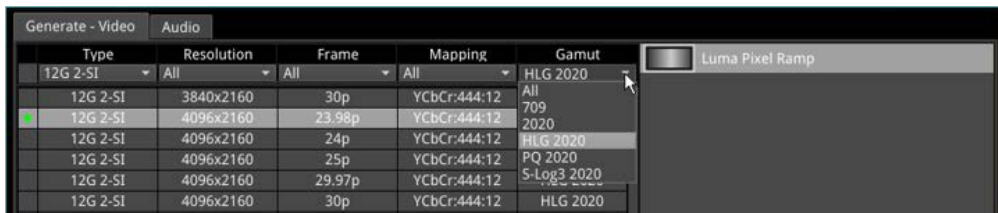

Figure 15-2: Selecting HDR Gamut from Generator Dropdown List

Transfer Curve and Colorimetry Overrides

HDR content may still contain the SMPTE payload ID for SDR and Rec.709 color space (as standard). When analyzing HDR and WCG content, therefore, you can choose to enable overrides in the submenu of the **Analyzer - Video Standard** Instrument for the appropriate HDR transfer curve and color space as follows:

- Enable Transfer Curve Override > [Enabled, Disabled]
- Transfer Curve Override > [SDR-TV, HLG, PQ, S-Log3]
- Enable Colorimetry Override > [Enabled, Disabled]
- Colorimetry Override > [Rec.709, Rec.2020]



Requires Option(s):

PHQXO-HDR

Overview

The CIE 1931 x y chart provides a display of signal chromaticity - complete with Rec. 709, Rec. 2020, ST 2086 gamut overlays and the Illuminant D65 white point reference.

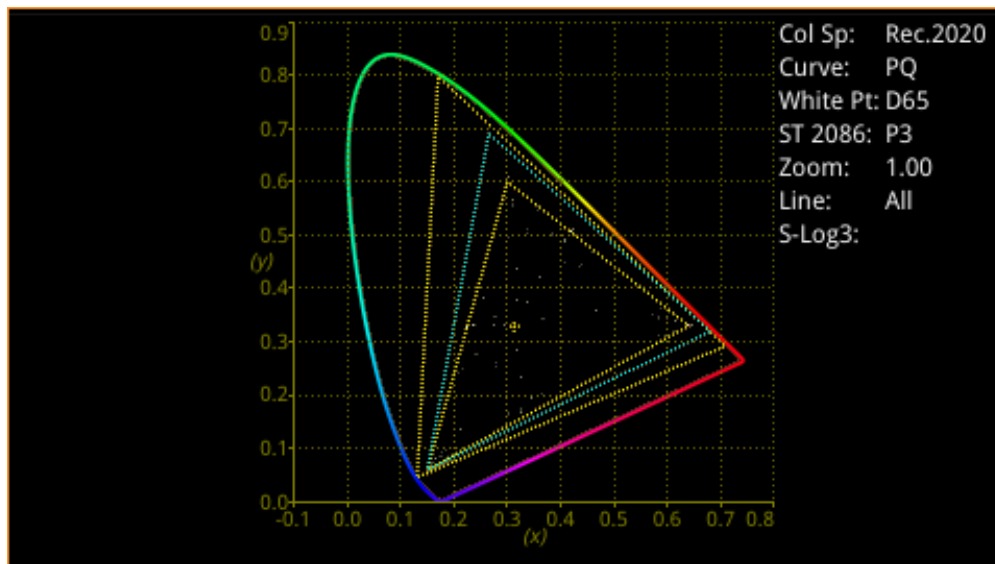

Figure 15-3: Analyzer - CIE Chart Instrument

Instrument Menu Options

Right-click in the chart area to access the setup submenu for the CIE Chart:

- Rec.709 Triangle > [Enabled, Disabled]
- Rec.2020 Triangle > [Enabled, Disabled]
- ST 2086 Triangle > [P3, Disabled]
- D65 White Point > [Enabled, Disabled]
- Single Line Mode > [Enabled, Disabled]
- Single Line Mode > Enabled > Line Number > [1 to Total no. of Active Lines for current standard]
- Zoom > [slider 1.00...4.00]
- Zoom > x Position > [slider, left to right]
- Zoom > y Position > [slider, bottom to top]
- Brightness > [slider 1..31]
- Gamma > [slider 1..255]
- Persistence [slider 1..255]
- S-Log3 Mode [S-Log3, SR Live]

You can zoom in/out of the chart by hovering the mouse crosshairs over the chart and scrolling the mouse wheel up or down. In addition, you can pan across the x or y axes by hovering the mouse crosshairs over the axis in question and scrolling the mouse wheel up or down.

HDR Heat-map (False Color Overlay)

Requires Option(s):	PHQXO-HDR
----------------------------	------------------

A false color overlay can be applied to the picture view, to highlight luminance ranges in the image that are of particular interest, whether High Dynamic Range (HDR) or otherwise.

The picture can also be displayed in monochrome using grayscale shades. If enabled at the same time as False Color Highlighting, all image elements outside of the enabled false color overlay luminance range(s) are displayed in monochrome; leaving the false color highlight elements to stand out more.

Different types of false color overlay may be applied to visualize different image details clearly, and the custom mode is provided to enable you to create a modified or bespoke overlay.

The range(s) and colors of a selected false color overlay can be modified by adjusting the seven overlay bands. Up to seven distinct ranges can be simultaneously enabled in a single overlay. If adjusted, the new or modified overlay is designated as the Custom overlay type.

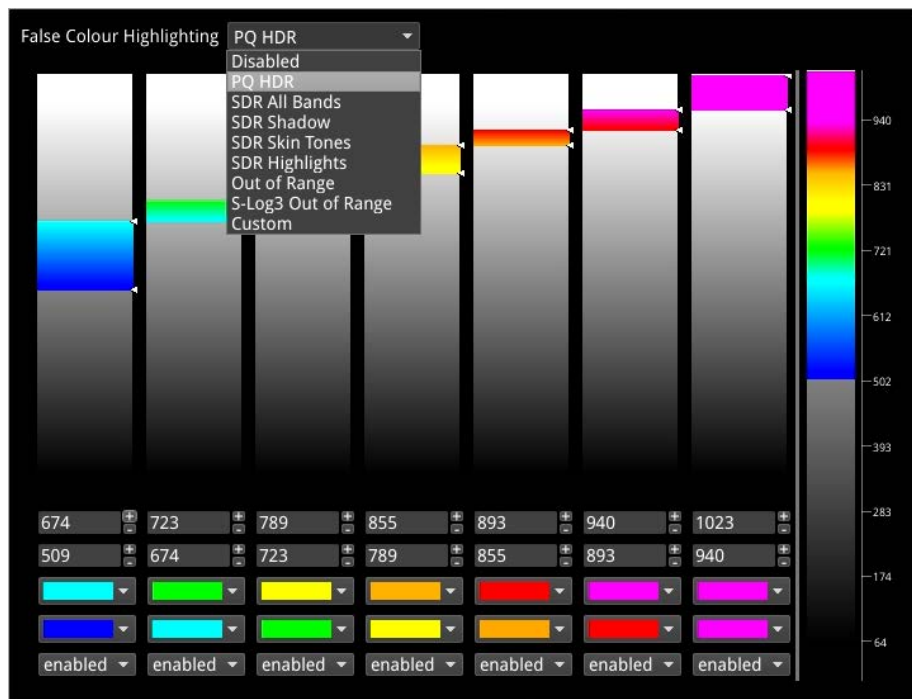

Figure 15-4: Configuring the False Color Overlay

When False Color Highlighting is enabled, a scale with numeric and graphic display of the luminance range(s) of the overlay in use, is available and the required luminance units for the scale can be selected.

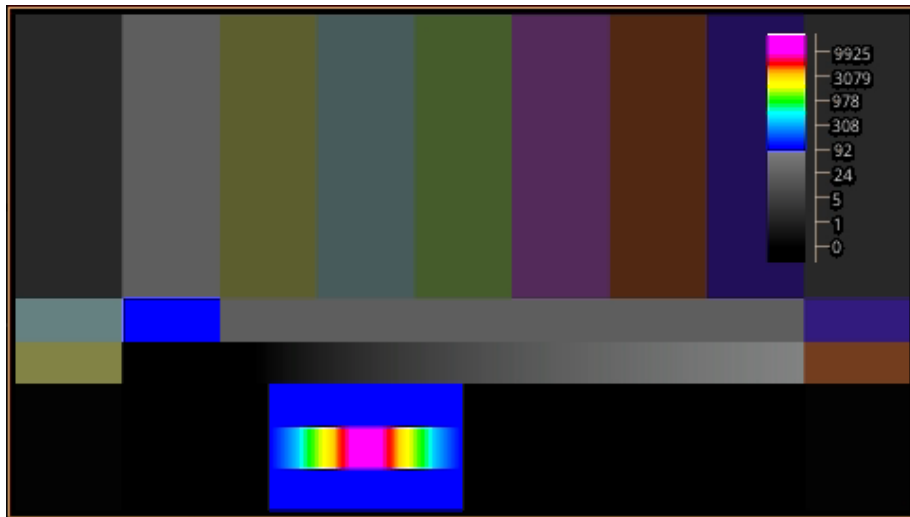

Figure 15-5: False Color Overlay Applied

Instrument Options (HDR)

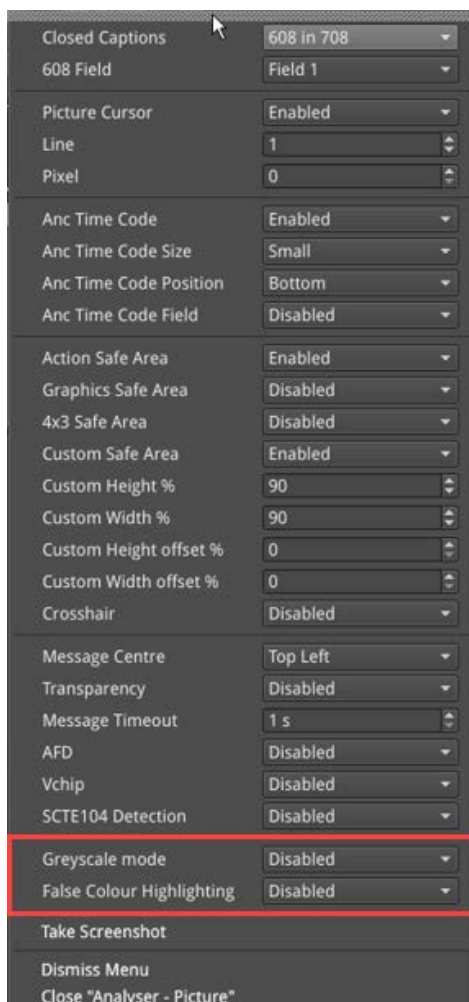

Figure 15-6: Analyzer - Picture Instrument Menu Showing HDR Options

The following table lists the options available with the Advanced HDR Toolset for the Analyzer - Picture and Analyzer - Picture Copy Instrument submenus:

Table 15-1: HDR Menu Options for the Analyzer - Picture Instrument

Item	Options	Description
Grayscale Mode	Disabled (Default) Enabled	When enabled, displays the Picture using grayscale shades rather than color.
False Color Overlay Scale	Disabled Enabled (Default)	Displayed when False Color Highlighting is enabled. When active, displays a scale, showing both numeric and graphic representation of the luminance range(s) of the selected overlay, at the left-hand side of the window.
Luminance Measurement	Decimal Level (Default) PQ Nits	Selects the measurement units for luminance used in false color highlighting.
False Color Ranges	Disabled, PQ HDR, SDR All Bands, SDR Shadow, SDR Skin Tones, SDR Highlights, Out of Range, S-Log3 Out of Range, Custom	Opens False Color Highlighting window. Adjust any of the seven overlay bands to modify the range(s) and colors of a selected false color overlay. You can enable up to seven distinct ranges simultaneously in a single overlay. If adjusted, the new or modified overlay is designated as the Custom overlay type.

Additional System Information

This chapter provides additional information on using the REST API and driver calibration. It includes the following sections:

- [Using the REST API for Remote Access](#)
- [Using REST API Requests](#)
- [Driver Calibration](#)

Using the REST API for Remote Access

You can use a standard REST API Client to interrogate the unit remotely by requesting data and status information, or to submit operational control commands.

Activating the REST API

Activate the REST API on the unit as follows:

1. Open the instrument: **Qx Network & Automation**.
2. Right-click in the window to open the submenu.
3. Enable the option: **REST API**.

When enabled, the REST API status in the Qx Network & Automation window displays the port number (8080) on which the unit is listening.

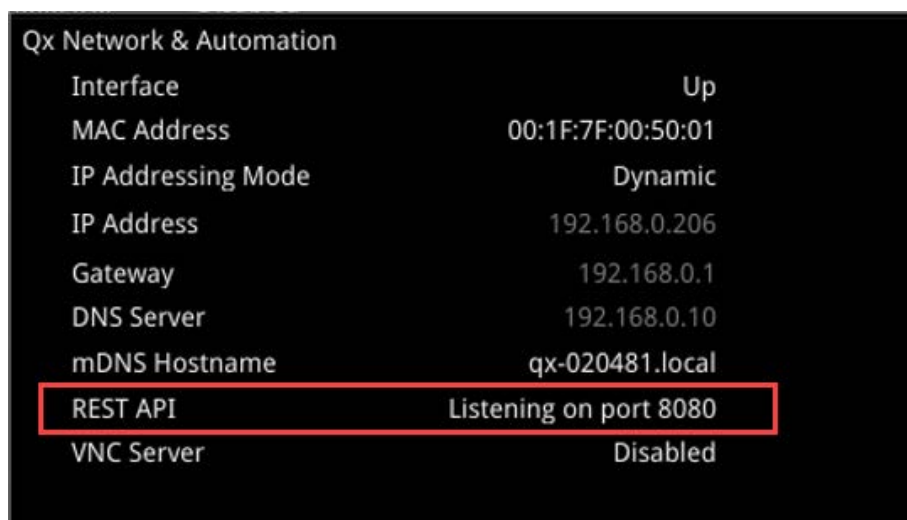

Figure 16-1: REST API Enabled in Network & Automation Window

Connecting Using the REST API

Connect to the unit using the REST API as follows:

1. Run your chosen REST API client application on the computer you will use to connect to the unit.
2. Use either the IP Address or mDNS Hostname (if mDNS is enabled on your computer) of the target unit, together with the port number, to connect to the unit.

For example, to submit a GET request, enter the specific IP Address or mDNS Hostname of the target unit, in one of the following formats:

- **http://192.168.0.70:8080/api**
- **http://qx-020094.local:8080/api**

See the section ["Using REST API Requests" on the facing page](#) for an overview of the GET and PUT requests for the REST API.

You can script the following REST API requests for use in automated testing:

- PUT
- GET

- DELETE
- POST

Contact PHABRIX for full details of all available REST API requests.

Using REST API Requests

Using REST API Requests in SDI Mode

The REST API request examples provided in this section for guidance use an example IP address (**192.168.0.142**) and the default REST API Port (**8080**).

The target base resource for REST API requests is: **/api**.

The target base URL for requests (GET) is in the format:

- **http://192.168.0.142:8080/api** or
- **http://qx-020094.local:8080/api**

You can submit REST API requests to:

- Report the current analyzed standard (GET):
 - **http://192.168.0.142:8080/api/v1/analyser/status**
- Report the currently generated standard (GET):
 - **http://192.168.0.142:8080/api/v1/generator/status**
- Navigate through a list of available generator standards (GET):
 - **http://192.168.0.142:8080/api/v1/generator/standards**
 - Select the required URL from the tree structure and use GET again to drill-down to the appropriate color format, bit depth, level, SDR or HDR format, and test pattern.
- Generate a standard (PUT):
 - **http://192.168.0.142:8080/api/v1/generator/standards/1920x1080p60/**
YCbCr%3A422%3A10/3G_A_Rec.709/100%25%20Bars
 - You can also add a pathological overlay, specifying its type and number of pairs by including a raw payload of, for example:
 - **{"action":"start","pathological":{"type":"CheckField","pairs":100}}**
- Report the currently generated audio standard (GET):
 - **http://192.168.0.142:8080/api/v1/generator/audio**
- Audio generation (PUT):
 - **http://192.168.0.39:8080/api/v1/generator/audio**
 - Include a raw payload for QuickConfig of the structure, for example:
 - **{"mode":"Fixed Tone","quickConfig":{"gainType":"Fixed Levels",**
"gain":-10,"pitch":"E 3"}}
 - For Custom config raw payload structure, refer to the GET request output structure.
- View instantaneous Eye readings (GET):
 - **http://192.168.0.142:8080/api/v1/eye/status**
- View instantaneous Jitter readings (GET):
 - **http://192.168.0.142:8080/api/v1/jitter/status**

- Retrieve the event logs (GET):
 - **http://192.168.0.142:8080/api/v1/eventlog/logs**
- Report current CRC analysis status (GET):
 - **http://192.168.0.142:8080/api/v1/analyser/crcSummary**
- Manage the event logs (PUT):
 - **http://192.168.0.142:8080/api/v1/eventlog/config/restApi**
 - With a raw payload of:
 - **{"action":"enable"}**
 - In this example, to enable REST API event logging.

Using REST API Requests in IP Mode

Specifically in IP Mode, you can use REST API requests to:

- Report the currently active multicast request (GET):
 - **http://192.168.0.142:8080/api/v1/ipReceive/multicastRequests**
- Request a new multicast (PUT):
 - **http://192.168.0.142:8080/api/v1/ipReceive/multicastRequests**
 - With a raw payload of the form:
 - **{"action":"request","destinationIpAddress":"230.0.0.15"}**
 - In this example, to join a multicast group of destination IP address: 230.0.0.15
- Report the list of currently available IP media streams (GET):
 - **http://192.168.0.142:8080/api/v1/ipReceive/mediaStreams**
- Select the IP media stream for analysis (PUT):
 - **http://192.168.0.142:8080/api/v1/ipReceive/mediaStreams**
 - With a raw payload of the form:
 - **{"action":"analyseStream","destinationIpAddress":"230.0.0.15", \ "destinationUdpPort":16,"matchSrc":true,"sourceIpAddress": "192.168.10.30", \ "sourceUdpPort":16,"src":123456}**
- Report the IP media stream currently being analyzed (GET):
 - **http://192.168.0.142:8080/api/v1/ipReceive/requestedMediaStreams**
- Clear the list of IP media streams (PUT):
 - **http://192.168.0.142:8080/api/v1/ipReceive/mediaStreams**
 - With a raw payload of:
 - **{"action":"clearList"}**

Contact PHABRIX for full details of all available REST API requests.

Driver Calibration

Requires Option(s):	PHQX01E-3G
---------------------	------------

Overview

All PHABRIX units are calibrated and verified before dispatch. Over time, however, the optional SDI generator outputs of the unit may require recalibration as described in this section.

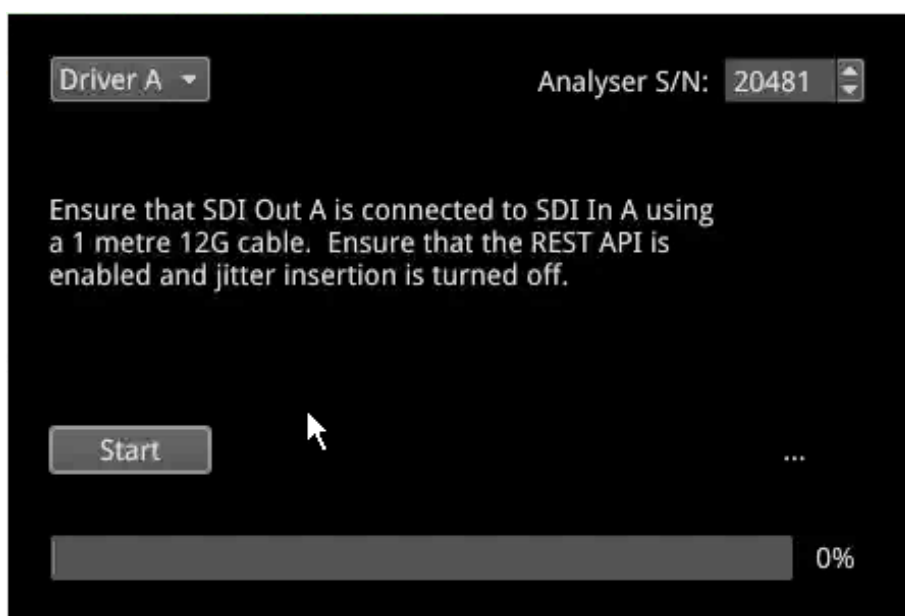

Figure 16-2: Driver Calibration Window

On units with PHABRIX RTE™ (RealTime Eye) capability, the SDI generator outputs of the unit can each be calibrated using the SDI In A input.

Note: Recalibration relies upon the calibration status of the Eye/Jitter analyzer. If in doubt consider returning the unit to PHABRIX for calibration.

SDI Output Calibration Steps

Warning: Before attempting to calibrate the unit, make sure that you use a 12G cable that complies with the specification described below. If in doubt, do not attempt to perform calibration on your unit.

Calibrate the unit as follows:

Note: If the unit is in **SDI Stress Toolset** mode, first disable **Jitter Insertion Mode** before beginning driver calibration. See the section ["Advanced Generation Tools \(SDI Stress Mode\)" on page 14-2](#) for further details.

1. Connect a one meter long cable between the SDI In A input (black or red nut) and the SDI output to be calibrated. A 12G-SDI grade or compatible cable with 12G-SDI BNCs must be used. A suitable cable type is Belden 1694A.

2. Open the **Instrument Launch Menu** and select: System Settings > Driver Calibration to open the calibration window.
3. Select the output to calibrate from the dropdown menu, for example, for SDI Output A, select Driver A and so on.
4. Click Start to begin calibration. It can take up to five minutes to calibrate an output.
5. On completion of calibration for SDI Output A, connect the output side of the cable to SDI Output B and repeat the steps above, until you have calibrated all SDI Outputs. It may take about 20 minutes to calibrate all four outputs.

Technical Specifications

This Appendix defines the technical specifications of your unit and includes the following sections:

- [Power](#)
- [External Locking Reference](#)
- [SDI Instrument Output](#)
- [HDMI Instrument Output](#)
- [USB Connectors](#)
- [Networking](#)
- [Rear Panel D26 Connector](#)
- [GPIO](#)
- [AES Input/Output](#)
- [Longitudinal Timecode \(LTC\)](#)
- [Analog Audio Output](#)

Technical Specifications

Power

Connector	4-pin XLR, Male
Voltage	10 - 18 V, 12 V DC nominal. DC Power adapter provided. Overvoltage, undervoltage and reverse voltage protection.

External Locking Reference

Label	REF
Input Signal	Tri-level or Bi-Level (black burst) syncs 50 / 59.94 / 60 Hz
Connector	2 x BNC
Input Impedance	> 10 kohm
Input Return Loss	> 40 dB to 6 MHz (typical)
Maximum Input voltage	+/- 2 V
Specification	Tri-level syncs (SMPTE 274M and SMPTE 296M) 600 mV pk-pk PAL Black Burst (ITU 624-4/SMPTE 318) 1V pk-pk, Composite NTSC (SMPTE 170M) 1V pk-pk

SDI Instrument Output

Label	SDI OUT
Connector	BNC
Output Impedance	75 ohm
Output Level	800 mV p-p +/- 10 %
Purpose	3 Gbps SDI instrument output

HDMI Instrument Output

Label	HDMI
Connector	Type A
Video Format	1920 x 1080 RGB 4:4:4
Audio Format	4 x PCM stereo audio at 48 kHz
Purpose	Monitor output that allows up to 16 individual instrument panels (or windows) to be displayed. Supports auto DVI mode over HDMI to connect DVI KVM Extenders for remote installations.

USB

USB	USB 2
USB Connector	Type A
Quantity	3 (1 x front-mounted, 2 x rear-mounted)
Purpose	Keyboard and mouse control of the HDMI® monitor output of instrument and software installation.

Networking

Ethernet IEEE 802.3 10 / 100 / 1000 Mb/s (10 / 100 / 1000 base-T)
 Ethernet Connector RJ-45

Rear panel D26

Label I/O Expansion
 Connector 26-way D-type
 Purpose 8 x GPI I/O, 4 x AES I/O, LTC input, stereo analog audio out
 Pinout



Table A-1: D26 Connector Pin-outs

Pin Number	Pin Name	Description	Hardwired GPIO Assignments (Non-2110 Modes)	Hardwired GPIO Assignments (2110 Mode)
1	AES_IO1	Bidirectional AES I/O - 75 ohm unbalanced	N/A	N/A
2	AES_IO2	Bidirectional AES I/O - 75 ohm unbalanced	N/A	N/A
3	AES_IO3	Bidirectional AES I/O - 75 ohm unbalanced	N/A	N/A
4	AES_IO4	Bidirectional AES I/O - 75 ohm unbalanced	N/A	N/A
5	LTC_RX_P	LTC Receive (RX) P (RS-422 compatible)	N/A	N/A
6	LTC_RX_N	LTC Receive (RX) N (RS-422 compatible)	N/A	N/A
7	AUDIO_R	Audio Line Out - right	N/A	N/A
8	AUDIO_L	Audio Line Out - left	N/A	N/A
9	5V0_GPIO	5 V current limited GPIO supply (500 mA)	N/A	N/A
10, 11, 12, 13, 14, 15, 16, 17, 18	GND	0 V	N/A	N/A
19	GPIO-0	Open drain, 10 kohm pull-up to + 5 V	Pathological signal output on SDI A Pulses on detection of a PLL pathological condition.	1 PPS output for the selected PTP engine when System Reference set to PTP. Off when System Reference set to Free Run.
20	GPIO-1	Open drain, 10 kohm pull-up to + 5 V	Pathological signal output on SDI A Pulses on detection of an Equalizer pathological	1 PPS for SFP A when PTP Engine is enabled; off when not enabled.

Pin Number	Pin Name	Description	Hardwired GPIO Assignments (Non-2110 Modes)	Hardwired GPIO Assignments (2110 Mode)
			condition.	
21	GPIO-2	Open drain, 10 kohm pull-up to + 5 V	Pathological signal output on SDI B Pulses on detection of a PLL pathological condition.	1 PPS for SFP B when PTP Engine is enabled; off when not enabled.
22	GPIO-3	Open drain, 10 kohm pull-up to + 5 V	Pathological signal output on SDI B Pulses on detection of an Equalizer pathological condition.	N/A
23	GPIO-4	Open drain, 10 kohm pull-up to + 5 V	Pathological signal output on SDI C Pulses on detection of a PLL pathological condition.	N/A
24	GPIO-5	Open drain, 10 kohm pull-up to + 5 V	Pathological signal output on SDI C Pulses on detection of an Equalizer pathological condition.	N/A
25	GPIO-6	Open drain, 10 kohm pull-up to + 5 V	Pathological signal output on SDI D Pulses on detection of a PLL pathological condition.	N/A
26	GPIO-7	Open drain, 10 kohm pull-up to + 5 V	Pathological signal output on SDI D Pulses on detection of an Equalizer pathological condition.	N/A

GPIO

Connector	26-way D-type (see previous table)
Pins	19 (GPIO - 0), 20 (GPIO - 1), 21 (GPIO - 2), 22 (GPIO - 3), 23 (GPIO - 4), 24 (GPIO - 5), 25 (GPIO - 6), 26 (GPIO - 7)
Format	Open drain with 10 kohm pull-up to +5 Volts
Power	5 V (pin 9), current-limited GPIO supply for open drain input/outputs. 0 V / signal ground (pins 10 to 18)
Purpose	Generator Pathological Rate Detection

AES I/O

Connector	26-way D-type
Pins	1 (AES I/O 1), 2 (AES I/O 2), 3 (AES I/O 3), 4 (AES I/O 4)

Input Impedance	75 ohm terminated
Maximum Input voltage	+/- 2 V
Input Sample Rate	48 kHz synchronous audio
Input Bit Depth	20 bit or 24 bit
Output Sample Rate	48 kHz synchronous to system reference
Output Bit Depth	24 bit
Specification	Conforming to AES3-2003 and SMPTE-276M
Purpose	4 x AES I/O audio

Longitudinal Timecode (LTC)

Connector	26-way D-type
Pins	5 (RX - P), 6 (RX - N)
Format	RS-422 Compatible
Purpose	Not currently supported in software

Analog Audio Output

Connector	26-way D-type
Pins	7 (Audio Line Out - Right), 8 (Audio Line Out - Left)
Type	Stereo Pair
Level	(1 V peak-to-peak analog audio, full scale 0 dBFS)
Purpose	Audio Monitoring output

Advanced Media Timing Information

This Appendix provides additional information about the advanced media timing measurements you can make using the **Video Timing & System Reference** instrument and includes the following sections:

- [Overview](#)
- [Measurements in the Video Timing Tab](#)
- [Measurements in the Media Latency Tab](#)

Advanced Media Timing Measurements

Requires Option(s):	PHQXO1-IP-STND and PHQXO1-IP-MEAS
---------------------	-----------------------------------

Overview

This appendix provides additional detail on the advanced media timing measurements available in the **Video Timing & System Reference** instrument when the **PHQXO-IP-MEAS** license is installed. For information on using the Instrument, see the sections ["Video Timing & Setting External Reference in IP 2110 Mode" on page 5-26](#) and ["Video Timing & System Reference \(IP 2110 Mode\)" on page 5-38](#)

Advanced Media Timing Definitions

The following terms are used in this section and are defined as follows:

Table B-1: Advanced Media Timing Definitions

Term	Definition
TPA_0	The PTP arrival time of the first packet of a frame, for progressive video, or field one, for interlaced video, as measured.
TPR_0	The time when the receiver is expected to read the packet from its receive buffer. It is set by TR_{Offset} which can be either the default value or set in the Session Description Protocol (SDP).
$N * T_{Frame}$	The Epoch-aligned start of the last frame as defined in ST 2059-1.
T_{VD}	A time-point at which $N * T_{Frame} + TR_{Offset}$ is an integer and the time-scale has its origin at the SMPTE Epoch as defined in SMPTE ST 2059-1.
$RTP_{Timestamp}$	The time contained in the timestamp within the received packet.

Video IP Packet Timing Schematics

The graphics on the following pages are provided to illustrate the subsequent descriptions of the advanced media timing measurements. The first, Figure B-1, shows the IP video packet timing at the Sender and Figure B-2 shows the IP video packet timing at the receiver.

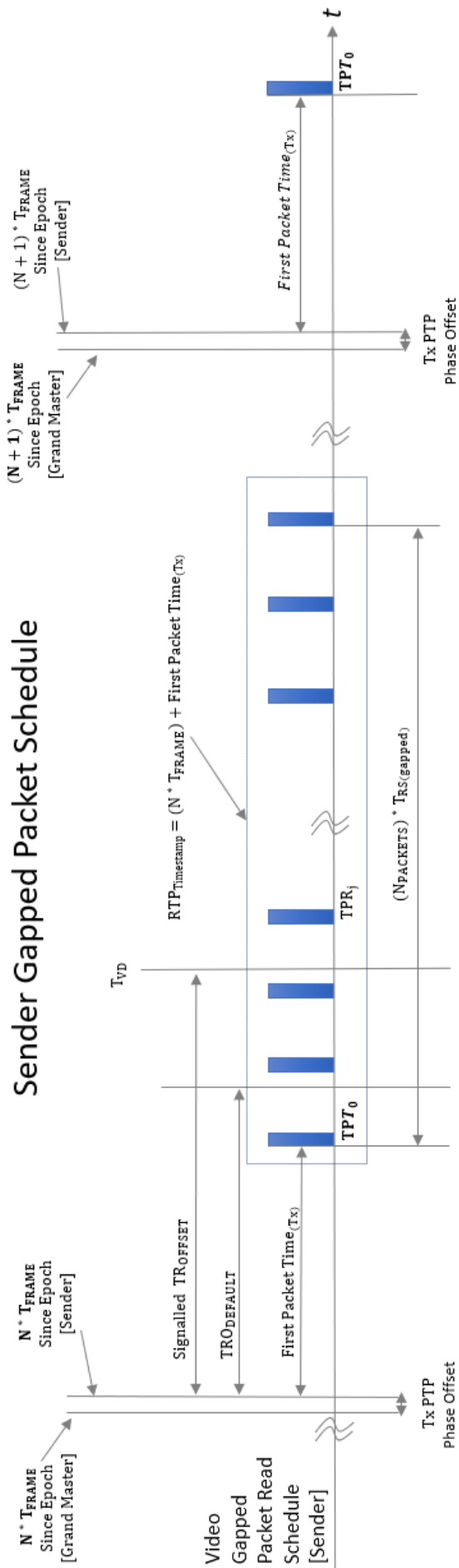

Figure B-1: Sender Gapped Packet Schedule

Measurements in the Video Timing Tab

Video Timing (First Packet Time) Measurement

The **Video Timing** measurement is analogous to the SDI or Analog vertical interval timing measurement where the start of frame is measured with respect to an analog external reference. The unit calculates Video Timing as follows:

$$\text{Video Timing} = \text{TPA}_0 - N * T_{\text{Frame}} \text{ (averaged over 1 second)}$$

Where:

- **TPA₀** is the arrival PTP time of the first packet of a frame for progressive or field one for interlaced video as measured as measured by the unit
- **N * T_{Frame}** is the Epoch-aligned start of the last frame as defined in ST 2059-1, as reconstructed by the unit.

By default, the Video Timing value is always positive, however, if you enable the Wrap frame option in the submenu, the unit displays any values greater than half a TV frame period as negative values with respect to the next TV frame.

This measurement is affected by:

- The PTP Lock and Phase Offset of the Sender and unit (Receiver)
- The network propagation delay
- The timing relationship between the Source media Frame Sync and the PTP-derived Frame Sync
- The relationship of the underlying Media Clock to PTP, and whether the media is locked to PTP.

The unit measures Video Timing using the receiver time reference for the two sampling points and does not make use of RTP timestamps. Consequently, Video Timing can be measured with high precision as it is not quantized by source RTP clocks. The measurement uncertainty is a function of the hardware timestamp, which has a resolution of approximately 100 ns. The measurement varies with the unit's PTP estimated phase offset, and the PTP delay control.

SMPT E ST 2110-21 defines a nominal or ideal value of the sender's Video Timing (**TRO_{Default}**) for each video format as shown in the following table:

Table B-2 : SMPTE ST 2110-21 Nominal Sender's Video Timing TRO_{Default} by Video Format

Video Format	Frame Rate (F/s)	TRO _{Default} (μs)	TRO _{Default} Integer (μs)
525i	29.97002997	1271.111	1271
625i	25	1664.000	1664
720p	23.97602398	1557.111	1557
	24	1555.556	1556
	25	1493.333	1493
	29.97002997	1245.689	1246
	30	1244.444	1244
	47.95204795	778.556	779
	48	777.778	778

Video Format	Frame Rate (F/s)	TRO _{Default} (μs)	TRO _{Default Integer} (μs)
	50	746.667	747
	59.94005994	622.844	623
	60	622.222	622
<hr/>			
1080i	23.97602398	815.63	816
	24	814.815	815
	25	782.222	782
	29.97002997	652.504	653
	30	651.852	652
<hr/>			
1080p	23.97602398	1594.185	1594
	24	1592.593	1593
	25	1528.889	1529
	29.97002997	1275.348	1275
	30	1274.074	1274
	47.95.204795	797.093	797
	48	796.296	796
	50	764.444	764
	59.94005994	637.674	638
	60	637.037	637
<hr/>			
1080PsF	23.97602398	815.63	816
	24	814.815	815
	25	782.222	782
	29.97002997	652.504	653
	30	651.852	652
	47.95204795	407.815	408
	48	407.407	407
	50	391.111	391
	59.94005994	326.252	326
	60	325.926	326

Note: If the underlying Media Clock is not locked to PTP (for example, if it originates from an SDI player that cannot be generator locked (genlocked) being played through an SDI-to-2110 gateway) then the Video Timing measurement will have a value that is determined mainly by the video source to PTP timing relationship.

Note: If the source is not locked to PTP, then the value of the Video Timing measurement will drift continuously.

Margin Measurement

The **Margin** is the difference between the First Packet Time (video timing measurement) and the time of the first video buffer read in the receiver. The indicated **TR_{Offset}** is used to control the read schedule of the receiver buffer and the Margin is the amount of buffer pre-fill prior to the start of the buffer read process. The Margin is calculated as follows:

$$\text{Margin} = \text{TPA}_0 - (\text{N} * \text{T}_{\text{Frame}} + \text{TR}_{\text{Offset}}) = \text{First Packet Time} - \text{TR}_{\text{Offset}}$$

The Margin measurement will be affected by the following:

- **TR_{Offset}**
- The PTP Lock and Phase Offset of the Sender and unit (Receiver)
- The network propagation delay
- The timing relationship between the Source media Frame Sync and the PTP derived Frame Sync
- The relationship of the underlying Media Clock to PTP, and whether the media is locked to PTP.

The unit provides a facility to enter a manual value for the **TR_{Offset}** in the Instrument submenu. In the absence of a manual value of **TR_{Offset}** the unit will use the **TR_{Default}** value for that video format, see the table in ["Measurements in the Video Timing Tab" on page B-5](#).

A negative value indicates that the packets are arriving earlier than expected for an idealized system, implying that the receiver has more time to buffer and consequently, has more margin.

A positive value indicates that the packets are arriving later than expected for an idealized system, and that the size of the available buffer is being reduced.

If the video phase of the source is adjusted so that the Margin is zero, then the measured Video Timing should then be equal to the **TR_{Offset}**.

Note: If the underlying Media Clock is not locked to PTP (for example, if it originates from an SDI player that cannot be genlocked being played through an SDI-to-2110 gateway) then the Margin measurement will have a value that is determined mainly by the video source to PTP timing relationship.

RTP Offset Measurement

This measurement is the difference between the time encoded in the RTP timestamp and the start of the frame for progressive or first field for interlaced since the epoch, averaged over 1 second. A camera will typically timestamp at the image capture instant. An SDI gateway will timestamp at the start of the frame, and a synthetic source can timestamp at the start of the frame or at the time the first packet egresses from the sender. For an SDI to ST 2110 gateway, when the source video timing has been adjusted to give a Video Timing measurement value that is equal to **TR_{Default}** (a Margin of zero), then the RTP Offset is an indication of the timing relationship of the source video to PTP. The RTP Offset is calculated as follows:

$$\text{RTP Offset} = \text{RTP}_{\text{Timestamp}} - \text{N} * \text{T}_{\text{Frame}} \text{ (averaged over 1 second)}$$

Where:

- **RTP_{Timestamp}** is the time contained in the timestamp within the received packet, created by the source
- **N * T_{Frame}** is the Epoch-aligned start of the last frame as defined in ST 2059-1 as reconstructed by the unit.

In principle, the RTP Offset measurement will be affected by:

- The PTP Lock and Phase Offset of the Sender and unit (Receiver)
- The relationship of the underlying Media Clock to PTP, and whether the media is locked to PTP.

The unit calculates the RTP Offset by subtracting the Video Latency measurement from the Video Timing measurement; a method that is insensitive to the PTP phase offset of the unit, and the PTP lock or phase of the source.

The PTP time of the **RTP_{Timestamp}** is limited by the resolution of the source RTP Media Clock. For ST 2110-20 Video this clock is 90 kHz and has a quantization of 11 μs. The true PTP time at which a packet is assembled in the sender output buffer will be a point within this 11 μs RTP window so, even in a perfect system, the measurements may include an error of up to 11 μs.

PTP Phase offset can be affected by network asymmetric delay, which differs for both source and receiver, plus the inherent phase drift of the PTP daemon.

Note: If the underlying media clock is not locked to PTP (for example, if it originates from an SDI player that cannot be generator locked (genlocked) being played through an SDI-to-2110 gateway) then the RTP Offset measurement will have a value that is determined mainly by the video source to PTP timing relationship.

The RTP Offset is a valid measurement for all ST 2110 flows (gapped, linear, wide, narrow) and ST 2022-6 flows that use PTP, where the timing point in ST 2022-6 video is the first active pixel or Frame or Field sync.

Measurements in the Media Latency Tab

Media Latency Measurement

The **Media Latency** measure is the difference between the arrival time of a packet and the time encoded in the RTP timestamp of that packet, averaged over 1 second. This measurement applies to video, ANC, and audio since it does not depend on a frame structure. For video, it applies to the first packet of the frame and is calculated as follows:

$$\text{Latency} = \text{TPA}_0 - \text{RTP}_{\text{Timestamp}} \text{ (averaged over 1 second)}$$

Where:

- **TPA₀** is the arrival PTP time of the first packet of a frame, for progressive video, or field one, for interlaced video, as measured by the unit.
- **RTP_{Timestamp}** is the time contained in the timestamp within the received packet created by the source.

For Video and ANC flows, the RTP timestamp is constant for the entire Frame, so the latency is only measured when the RTP timestamp changes. This occurs on the first packet of a frame for a progressive flow, or field for an interlaced flow, with the results averaged over 1 second.

For Audio flows, as the RTP timestamp increments with each audio packet the latency is measured for every packet with the results averaged over 1 second.

This measurement will be affected by:

- The Sender Encapsulation Time (packet time)
- PTP Lock and Phase Offset of the Sender and unit (Receiver)
- Network propagation delay
- The relationship of the underlying Media Clock to PTP and whether the media is locked to PTP.

This is an indication of the true latency of each flow from source to destination and the time difference that a receiver or gateway will need to accommodate in order to co-time the flows. The longest latency of the associated flows is therefore the minimum co-timed delay through the network.

The PTP time of **TPA₀** is calculated by the receiving hardware timestamp and is not limited by the RTP or Media Clock rate. This timestamp has a resolution of approximately 100 ns and the measurement varies with the PTP estimated phase offset, and the PTP delay control.

The PTP time of the **RTPTimestamp** is limited by the resolution of the source RTP Media Clock. For ST 2110-20 Video and ST 2110-40 ANC this clock is 90 kHz and has a quantization of 11 μs. The true PTP time at which a packet is assembled in the sender output buffer will be a point within this 11 μs RTP window so, even in a perfect system, the measurements may include an error of up to 11 μs.

For ST 2110-30 and ST 2110-31 Audio the Media Clock is 48 kHz and the measurement error increases to 20.8 μs. For an audio packet time of 1 ms this equates to an uncertainty of 2 %, however, a 125 μs audio packet time increases the uncertainty to 16.64 %.

When measuring Audio and ANC to Video timing these RTP timing errors are compounded and are at the limits of the 2110 system.

PTP Phase offset can be affected by network asymmetric delay that differs for the source and receiver, plus the inherent phase drift of the PTP daemon.

Note: If the underlying Media Clock is not locked to PTP (for example, if it originates from an SDI player that cannot be genlocked being played through an SDI-to-2110 gateway) then the source encapsulator will be forced to add or drop packets in order to accommodate the differences in time-bases and this will manifest itself as a change in the nominal 90 kHz or 48 kHz RTP ticks and measured latency. In this case, you will notice that the measured latency value will cyclically and slowly increment or decrement and then jump back.

Note: If the source is not locked to PTP, then the latency measurement will continuously drift.

RTP Clock and Timestamps

IP media systems apply the concepts of the **Media Clock**, the **RTP Clock** and the **RTP Timestamp**.

The **Media clock** is a clock, defined in SMPTE ST 2110-10 to be frequency-locked to PTP, and it advances at an exact rate for each type of media essence. This is not necessarily the same as the Media sampling clock, for example, 74.25 or 74.25/1.001 MHz for HD Video, but happens to be the same for 48 kHz sampled PCM Audio.

The **RTP clock** is the clock used to derive the RTP Timestamp carried in the RTP packet header. The RTP timestamp increments at the rate of the RTP clock, and the timestamp has a value of zero, the SMPTE Epoch defined in ST 2059-1, which is the same as the PTP Epoch defined in IEEE 1588-2008. For reference, the SMPTE Epoch is defined as midnight International Atomic Time (TAI) on the 01 January 1970 [1970-0101T00:00:00TAI] and is 63092010 seconds before the UTC Epoch 1972-01-01T00:00:00Z (UTC), that is, PTP time is not the same as UTC time.

The RTP Clock is defined to be identical to its associated Media Clock in ST 2110-10.

The RTP (or Media) Clock rates are defined in the SMPTE standards ST 2110-20 (Video), ST 2110-30 and ST 2110-31 (Audio) and ST 2110-40 (ANC), and are listed in the following table:

Table B-3 : RTP Clock Rates for ST 2110-20, -30, -31 and -40

Media Essence Type	SMPTE Standard	RTP/Media Clock Rate
Video	ST 2110-20	90 kHz

Media Essence Type	SMPTE Standard	RTP/Media Clock Rate
Audio	ST 2110-30/31	48 kHz
ANC	ST 2110-40	90 kHz

The Video and ANC Media/RTP clock rate is constant for all video frame rates and should not change even with 1000/1001 non-integer frame rates.

The unit measures the actual value of the RTP clock averaged over 1 second and reports the value in the **RTP clks** data column. If the reported values do not match the specified values, this is an indication that either media flows or the sender is not correctly locked to PTP.

While the Video and ANC Media/RTP clock rate is 90 kHz (that is, the value of the timestamp increments every 11.111... μ s) the value of the RTP Timestamp is chosen to be a constant for an entire video frame and is analogous to the timecode of that frame. The chosen timestamp value for the frame is the nearest value of the 90 kHz derived timestamp at the start of the frame.

Video and ANC Timestamps/Second (TS/s)

The unit measures the received number of unique timestamps per second for each media essence type and updates the reported value every second in the **TSs** data column. The measured number of unique timestamps in each second will be an integer value.

For example, for a video or ANC flow with a frame rate of 50 Hz there will be 50 unique timestamps per second.

Audio Timestamps/Second (TS/s)

For Audio flows conforming to ST 2110-30 and ST 2110-31, the number of unique timestamps per second will vary with the audio packet time. This version of software supports Audio packet times of 1 ms and 125 μ s, as shown in the following table:

Table B-4 : Audio Timestamps per Second

Audio Packet Time	Unique Timestamps per Second (TS/s)
1 ms	1000
125 μ s	8000

RTP Clocks per Timestamp Quotient (RTP / TS)

The RTP / TS quotient is a measure of the number of RTP Clocks per Timestamp and is reported by the unit in the **RTP clks/TS** data column. For Video and ANC flows, the number of RTP clocks per timestamp will vary with the video frame rate. The nominal values are shown in the following table:

Table B-5 : Nominal RTP Clocks per Timestamp for Video

Video Frame Rate (Hz)	RTP Clocks per Time Stamp (RTP/TS)
60	1500
59.94	1501.5
50	1800
30	3000
29.97	3003
25	3600
24	3750

Video Frame Rate (Hz)	RTP Clocks per Time Stamp (RTP/TS)
23.98	3753.75

For Audio flows the number of RTP clocks/Timestamp will vary with the Audio Packet Time, and is equal to the number of audio samples per packet. For 48 kHz sampled audio the relationship between the Audio Packet Time and the RTP Clocks per timestamp per second is shown in the following table:

Table B-6 : Nominal RTP Clocks per Timestamp for Audio

Audio Packet Time	RTP Clocks per timestamp (RTP / TS)
1 ms	48
125 μ s	6

Working with Non-integer Frame Rates

For non-integer Video and ANC frame rates such as 60/1.001 (59.94 Hz) the unit receives 60 unique timestamps for 15 or 16 seconds, followed by one second that will contain 59 unique timestamps. For a 59.94 Hz system, the unit will, therefore, report 60 TS/s for 15 or 16 seconds followed by 59 TS/s for one second, resulting in a long-term average of 59.94 TS/s.

Similarly, the measured Video and ANC RTP/Media clock rate for a 59.94 Hz system will be 90,090 Hz (90,000 * 1.001) for 15 or 16 seconds, followed by a single second where the measured RTP Clock will be 88688 Hz or 88687 Hz, resulting in a long-term average of 90,000 Hz.

The reported number of RTP clocks per timestamp will also typically move away from the long-term nominal value for one second. The typical combination of measured values for the RTP Clock Rate, Timestamps/s and RTP Clocks per Timestamp for non-integer Frame and Field rates are given in the following table:

Table B-7 : Typical Reported RTP Clocks per Timestamp for Fractional Frame and Field Rates

Frame or Field Rate (Hz)	Reported RTP/Media Clock Rate	Reported Timestamps per Second (TS/s)	RTP Clocks per Timestamp (RTP/TS)	Interval(s)
60	90,000	60	1500	N/A
59.94	90,090	60	1501.5	16 or 17
	88,588	59	1501.49	
	88,589	59	1501.51	
50	90,000	50	1800	N/A
30	90,000	30	3000	N/A
29.97	90,090	30	3003	33 or 34
	87,087	29	3003	
25	90,000	25	3600	N/A

Frame or Field Rate (Hz)	Reported RTP/Media Clock Rate	Reported Timestamps per Second (TS/s)	RTP Clocks per Timestamp (RTP/TS)	Interval(s)
24	90,000	24	3750	N/A
23.98	90,090	24	3753.75	41 or 42
	86,336	23	3753.74	
	86,337	23	3753.76	

Un-locked Media Sources

It is possible to a situation where the 2110 Sender is locked to PTP, but the underlying media source of Video, Audio, ANC (for example, originating from a free-running SDI player being passed through an SDI-to-2110 gateway with no synchronizer) is not locked to PTP.

In this case, the reported media clock rate for the video, audio and ANC flows will not match any of the expected values shown in the previous table. In addition, the average latency measurement will go through a cyclical sequence where the latency will first increment, then jump back and repeat the cycle.

Sources Not Locked to PTP

When the sending device is not locked to PTP, the value of the latency measurement will drift continuously. This is over and above any cyclical behavior resulting from the underlying media not being locked to PTP.

On-going Development

PHABRIX is committed to developing the toolsets available on the unit, including upgrades to existing instruments and the introduction of new instruments. Please do not hesitate to contact PHABRIX at any time to discuss your requirements for the product or current product timelines.

SMPTE UHD TV: SDI Physical Layer Tolerances

The unit will automatically measure the SMPTE UHD TV tolerances listed in the following table:

Table C-1: SMPTE UHD TV Tolerances

Data Rate	1.485 Gbps	2.97 Gbps	5.94 Gbps	11.88 Gbps
Standard	SMPTE ST292-1:2012	SMPTE ST424:2012	SMPTE ST2081-1,10	SMPTE SMPTE ST2082-1,10
Coding	Scrambled NRZI	Scrambled NRZI	Scrambled NRZI	Scrambled NRZI
Amplitude	800 mV +/- 10 %	800 mV +/- 10 %	800 mV +/- 10 %	800 mV +/- 10 %
DC Offset	0.0 V +/- 0.5 V	0.0 V +/- 0.5 V	0.0 V +/- 0.5 V	0.0 V +/- 0.5 V
Rise/Fall Time	< 270 ps	< 135 ps	< 80 ps	< 45 ps
Rise/Fall Time Difference	< 100 ps	< 50 ps	< 35 ps	< 18 ps
Rise/Fall Overshoot	< 10 % of Amplitude	< 10 % of Amplitude	< 10 % of Amplitude	< 10 % of Amplitude
Timing Jitter	< 1 UI (10 Hz to 148.5 MHz)	< 2 UI (10 Hz to 297 MHz)	< 4 UI (10 Hz to 594 MHz)	< 8 UI (10 Hz to 1188 MHz)
Alignment Jitter	< 0.2 UI (100 kHz to 148.5 MHz)	< 0.3 UI (100 kHz to 297 MHz)	< 0.3 UI (100 kHz to 594 MHz)	< 0.3 UI (100 kHz to 1188 MHz)
75 ohm Coaxial Cable Length (Belden 1694A)	200 m	200 m	100 m	70 m

The complexity of both analyzing and generating signals for UHD TV is exemplified in the table. The data bandwidth testing from HD through to UHD TV at 12 Gbps, standard on the unit, is immense and the parameters set by SMPTE require that the instruments measure these critical values for compliance.

Supported SFPs

For information on the SFPs supported by the current software version, please contact PHABRIX Support at:

- www.phabrix.com/support

Supported Video Standards

Please contact PHABRIX if you require support for any standards not listed here. The current software version supports the following standards:

2K/HD Supported Formats

The following ST 2022-6 formats are supported by Qx option: PHQXO-IP-STND:

Table E-1: Supported 2K/HD Video Standards (SDI and ST 2022-6)

SMPTE Stnds. Link (Content)	Interface	Resolution	Sampling Structure	Pixel Depth	Frame/Field Rate	HDR	SDI	2022-6
ST 292 (ST 296)	HD	1280 x 720	4:2:2 (YCbCr)	10	60p, 59.94p, 50p, 30p, 29.97p, 25p,	O	●	O
ST 292 (ST 274)	HD	1920 x 1080	4:2:2 (YCbCr)	10	60i, 59.94i, 50i	O	●	O
ST 292 (ST 274)	HD	1920 x 1080	4:2:2 (YCbCr)	10	30p, 29.97p, 25p, 24p, 23.98p	O	●	O
ST 292 (RP 211)	HD	1920 x 1080	4:2:2 (YCbCr)	10	30psF, 29.97psF, 25psF, 24psF, 23.98psF	O	●	O
ST 292 (ST 2048-2)	HD	2048 x 1080	4:2:2 (YCbCr)	10	30p, 29.97p, 25p, 24p, 23.98p, 30psF, 29.97psF, 25psF, 24psF, 23.98psF	O	●	O
ST 425-1 (ST 274)	3G Level A (1)	1920 x 1080	4:2:2 (YCbCr)	10	60p, 59.94p, 50p	O	●	O
ST 425-1 (ST 2048-2)	3G Level A (1)	2048 x 1080	4:2:2 (YCbCr)	10	60p, 59.94p, 50p, 48p, 47.95p	O	●	O
ST 425-1 (ST 296)	3G Level A (2)	1280 x 720	4:4:4 (YCbCr/RGB) 4:4:4:4 (YCbCrA/RGBA)	10	60p, 59.94p, 50p, 30p, 29.97p	O	●	O
ST 425-1 (ST 274)	3G Level A (2)	1920 x 1080	4:4:4 (YCbCr/RGB) 4:4:4:4 (YCbCrA/RGBA)	10	60i, 59.94i, 50i, 30p, 29.97p, 25p, 24p, 23.98p, 30psF, 29.97psF, 25psF, 24psF, 23.98psF	O	●	O
ST 425-1 (ST 2048-2)	3G Level A (2)	2048 x 1080	4:4:4 (YCbCr/RGB) 4:4:4:4 (YCbCrA/RGBA)	10	30p, 29.97p, 25p, 24p, 23.98p, 30psF, 29.97psF, 25psF, 24psF, 23.98psF	O	●	O
ST 425-1 (ST 274)	3G Level A (3)	1920 x 1080	4:4:4 (YCbCr/RGB)	12	60i, 59.94i, 50i, 30p, 29.97p, 25p, 24p, 23.98p	O	●	O
ST 425-1 (ST 2048-2)	3G Level A (3)	2048 x 1080	4:4:4 (YCbCr/RGB)	12	30p, 29.97p, 25p, 24p, 23.98p, 30psF, 29.97psF, 25psF, 24psF, 23.98psF	O	●	O
ST 425-1 (ST 274)	3G Level A (4)	1920 x 1080	4:2:2 (YCbCr)	12	60i, 59.94i, 50i, 30p, 29.97p, 25p, 24p, 23.98p, 30psF, 29.97psF, 25psF, 24psF, 23.98psF	O	●	O
ST 425-1 (ST 2048-2)	3G Level A (4)	2048 x 1080	4:2:2 (YCbCr) 4:2:2:4 (YCbCrA)	12	30p, 29.97p, 25p, 24p, 23.98p, 30psF, 29.97psF, 25psF, 24psF, 23.98psF	O	●	O
ST 425-1 (ST 274)	3G Level B-DL	1920 x 1080	4:2:2 (YCbCr)	10	60p, 59.94p, 50p	O	●	O
ST 425-1 (ST 2048-2)	3G Level B-DL	2048 x 1080	4:2:2 (YCbCr)	10	60p, 59.94p, 50p, 48p, 47.95p	O	●	O
ST 425-1 (ST 274)	3G Level B-DL (I)	1920 x 1080	4:4:4 (YCbCr/RGB) 4:4:4:4 (YCbCrA/RGBA)	10	30p, 29.97p, 25p, 24p, 23.98p	A	●A	A
ST 425-1 (ST 2048-2)	3G Level B-DL (I)	2048 x 1080	4:4:4 (YCbCr/RGB) 4:4:4:4 (YCbCrA/RGBA)	10	30p, 29.97p, 25p, 24p, 23.98p	A	●A	A
ST 425-1 (ST 274)	3G Level B-DL (II)	1920 x 1080	4:4:4 (YCbCr/RGB)	12	30p, 29.97p, 25p, 24p, 23.98p	A	●A	A
ST 425-1 (ST 2048-2)	3G Level B-DL (II)	2048 x 1080	4:4:4 (YCbCr/RGB)	12	30p, 29.97p, 25p, 24p, 23.98p	A	●A	A
ST 425-1 (ST 274)	3G Level B-DL (IV)	1920 x 1080	4:2:2 (YCbCr)	12	30p, 29.97p, 25p, 24p, 23.98p	A	●A	A
ST 425-1 (ST 2048-2)	3G Level B-DL (IV)	2048 x 1080	4:2:2 (YCbCr)	12	30p, 29.97p, 25p, 24p, 23.98p	A	●A	A
ST 425-1 (ST 2048-2)	3G Level B-DL (IV)	2048 x 1080	4:2:2:4 (YCbCrA)	12	30p, 29.97p, 25p, 24p, 23.98p	A	●A	A

KEY

● - Generator and Analyzer as Standard (Unless Standard for Analyzer Only)

O - Optional

A - Analyzer Only

Table E-2 : Supported 2K/HD Video Standards (ST 2110)

Resolution	Sampling Structure	Pixel Depth	Frame/Field Rate	HDR	2110
1280 x 720	4:2:2 (YCbCr)	10	60p, 59.94p, 50p, 30p, 29.97p, 25p	O	O
1920 x 1080	4:2:2 (YCbCr)	10	60i, 59.94i, 50i	O	O
1920 x 1080	4:2:2 (YCbCr)	10	30p, 29.97p, 25p, 24p, 23.98p	O	O
1920 x 1080	4:2:2 (YCbCr)	10	30psF, 29.97psF, 25psF, 24psF, 23.98psF	O	O
2048 x 1080	4:2:2 (YCbCr)	10	30p, 29.97p, 25p, 24p, 23.98p, 30psF, 29.97psF, 25psF, 24psF, 23.98psF	O	O
1920 x 1080	4:2:2 (YCbCr)	10	60p, 59.94p, 50p	O	O
2048 x 1080	4:2:2 (YCbCr)	10	60p, 59.94p, 50p, 48p, 47.95p	O	O

Key:

- **O** - Optional
- **A** - Analyzer Only

4K/UHD Supported Formats

Table E-3 : Supported 4K/UHD SDI Video Standards

SMPTE Stnds. Link (Content)	Interface	Resolution	Sampling Structure	Pixel Depth	Frame/Field Rate	HDR	SDI
ST 425-3 Annex B.1 (ST 2036-1)	Quad-link HD-SQ	3840 x 2160	4:2:2 (YCbCr)	10	30p, 29.97p, 25p, 24p, 23.98p	O	O
ST 425-3 Annex B.1 (ST 2048-1)	Quad-link HD-SQ	4096 x 2160	4:2:2 (YCbCr)	10	30p, 29.97p, 25p, 24p, 23.98p	O	O
ST 2081-10 M1 (ST 2036-1)	6G-2SI	3840 x 2160	4:2:2 (YCbCr)	10	30p, 29.97p, 25p, 24p, 23.98p	O	O
ST 2081-10 M1 (ST 2048-1)	6G-2SI	4096 x 2160	4:2:2 (YCbCr)	10	30p, 29.97p, 25p, 24p, 23.98p	O	O
ST 425-5 (ST 2036-1)	Quad-link 3G-A (1) 2SI	3840 x 2160	4:2:2 (YCbCr)	10	60p, 59.94p, 50p	O	O
ST 425-5 (ST 2048-1)	Quad-link 3G-A (1) 2SI	4096 x 2160	4:2:2 (YCbCr)	10	60p, 59.94p, 50p, 48p, 47.95p	O	O
ST 425-5 (ST 2036-1)	Quad-link 3G-A, (1) 2SI	3840 x 2160	4:4:4 (YCbCr/RGB)	10	30p, 29.97p, 25p, 24p, 23.98p	O	O
ST 425-5 (ST 2036-1)	Quad-link 3G-A, (3) 2SI	3840 x 2160	4:4:4 (YCbCr/RGB)	12	30p, 29.97p, 25p, 24p, 23.98p	O	O
ST 425-5 (ST 2036-1)	Quad-link 3G-A, B (4) 2SI	3840 x 2160	4:2:2 (YCbCr)	12	30p, 29.97p, 25p, 24p, 23.98p	O	O
ST 425-5 (ST 2048-1)	Quad-link 3G-A (4) 2SI	4096 x 2160	4:2:2 (YCbCr) 4:2:2:4 (YCbCrA)	12	30p, 29.97p, 25p, 24p, 23.98p	O	O
ST 425-5 Annex B (ST 2036-1)	Quad-link 3G-A, B (1) SQ	3840 x 2160	4:2:2 (YCbCr)	10	60p, 59.94p, 50p	O	O
ST 425-5 Annex B (ST 2048-1)	Quad-link 3G-A, B (1) SQ	4096 x 2160	4:2:2 (YCbCr)	10	60p, 59.94p, 50p, 48p, 47.95p	O	O
ST 425-5 Annex B (ST 2036-1)	Quad-link 3G-A (2) SQ	3840 x 2160	4:4:4 (YCbCr/RGB)	10	30p, 29.97p, 25p, 24p, 23.98p	O	O
ST 425-5 Annex B (ST 2036-1)	Quad-link 3G-A (3) SQ	3840 x 2160	4:4:4 (YCbCr/RGB)	12	30p, 29.97p, 25p, 24p, 23.98p	O	O
ST 425-5 Annex B (ST 2036-1)	Quad-link 3G-A (4) SQ	3840 x 2160	4:2:2 (YCbCr)	12	30p, 29.97p, 25p, 24p, 23.98p	O	O
ST 425-5 Annex B (ST 2048-1)	Quad-link 3G-A (4) SQ	4096 x 2160	4:2:2 (YCbCr)	12	30p, 29.97p, 25p, 24p, 23.98p	O	O
ST 425-5 Annex B (ST 2048-1)	Quad-link 3G-A (4) SQ	4096 x 2160	4:2:2:4 (YCbCrA)	12	30p, 29.97p, 25p, 24p, 23.98p	O	O
ST 2081-11 M1, ST 425-5 (ST 2036-1)	Dual-link 6G-2SI (II)	3840 x 2160	4:4:4 (YCbCr/RGB)	10	30p, 29.97p, 25p, 24p, 23.98p	O	O
ST 2081-11 M1, ST 425-5 (ST 2048-1)	Dual-link 6G-2SI (II)	4096 x 2160	4:4:4 (YCbCr/RGB) 4:4:4:4 (YCbCrA/RGGBA)	10	30p, 29.97p, 25p, 24p, 23.98p	O	O
ST 2081-11 M1 ST 425-5 (ST 2036-1)	Dual-link 6G-2SI (III)	3840 x 2160	4:4:4 (YCbCr/RGB)	12	30p, 29.97p, 25p, 24p, 23.98p	O	O
ST 2081-11 M1, ST 425-5 (ST 2048-1)	Dual-link 6G-2SI (III)	4096 x 2160	4:4:4 (YCbCr/RGB)	12	30p, 29.97p, 25p, 24p, 23.98p	O	O
ST 2081-11 M1 ST 425-5 (ST 2036-1)	Dual-link 6G-2SI (IV)	3840 x 2160	4:2:2 (YCbCr/RGB)	12	30p, 29.97p, 25p, 24p, 23.98p	O	O
ST 2081-11 M1 ST 425-5 (ST 2048-1)	Dual-link 6G-2SI (IV)	4096 x 2160	4:2:2 (YCbCr) 4:2:2:4 (YCbCrA)	12	30p, 29.97p, 25p, 24p, 23.98p	O	O
ST 2082-10 M1, ST 425-5 (ST 2036-1)	12G-2SI (I)	3840 x 2160	4:2:2 (YCbCr)	10	60p, 59.94p, 50p	O	O
ST 2082-10 M1, ST 425-5 (ST 2048-1)	12G-2SI (I)	4096 x 2160	4:2:2 (YCbCr)	10	60p, 59.94p, 50p, 48p, 47.95p	O	O
ST 2082-10 M1 ST 425-5 (ST 2036-1)	12G-2SI (II)	3840 x 2160	4:4:4 (YCbCr/RGB)	10	30p, 29.97p, 25p, 24p, 23.98p	O	O
ST 2082-10 M1 ST 425-5 (ST 2048-1)	12G-2SI (II)	4096 x 2160	4:4:4 (YCbCr/RGB) 4:4:4:4 (YCbCrA/RGGBA)	10	30p, 29.97p, 25p, 24p, 23.98p	O	O
ST 2082-10 M1 ST 425-5 (ST 2036-1)	12G-2SI (III)	3840 x 2160	4:4:4 (YCbCr/RGB)	12	30p, 29.97p, 25p, 24p, 23.98p	O	O
ST 2082-10 M1 ST 425-5 (ST 2048-1)	12G-2SI (III)	4096 x 2160	4:4:4 (YCbCr/RGB)	12	30p, 29.97p, 25p, 24p, 23.98p	O	O
ST 2082-10 M1 ST 425-5 (ST 2036-1)	12G-2SI (IV)	3840 x 2160	4:2:2 (YCbCr)	12	30p, 29.97p, 25p, 24p, 23.98p	O	O
ST 2082-10 M1 ST 425-5 (ST 2048-1)	12G-2SI (IV)	4096 x 2160	4:2:2 (YCbCr) 4:2:2:4 (YCbCrA)	12	30p, 29.97p, 25p, 24p, 23.98p	O	O

Key:

- **O** - Optional
- **A** - Analyzer Only



PHABRIX®
A Leader Company

www.phabrix.com



PHABRIX products are continuously being updated.
Please visit www.phabrix.com for latest product information